

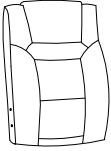

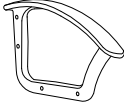

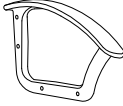

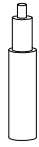
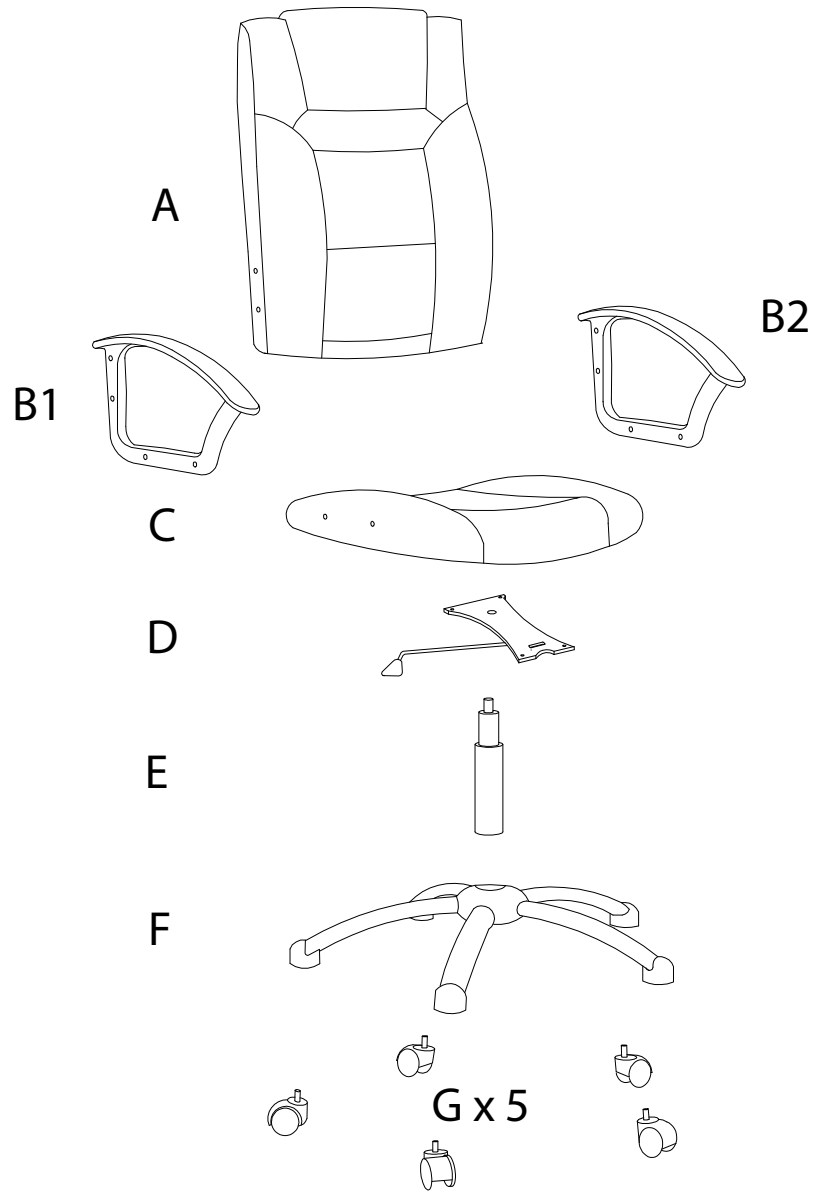

Assembly instructions for the chair base:

- Warning:** Do not use a power drill. Use an Allen key to tighten the base plate.
- Warning:** Do not place the chair on a soft surface like a rug. Place it on a hard, flat floor.
- Time:** 30 minutes.
- Personnel:** 1 person.

A	B1	B2	C	D	E
					
x 1	x 1	x 1	x 1	x 1	x 1

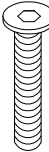
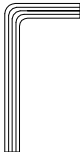

F	G	H	I	J
			 M6 x 20	
x 1	x 5	x 8	x 12	x 1



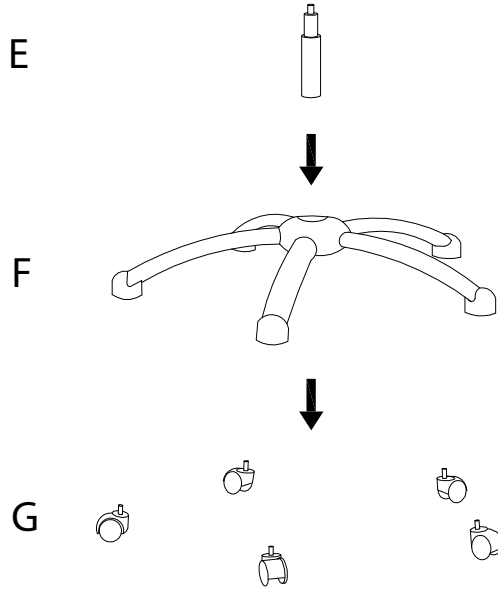
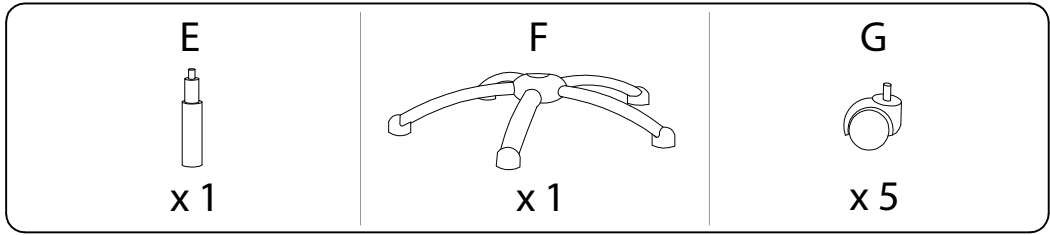

1

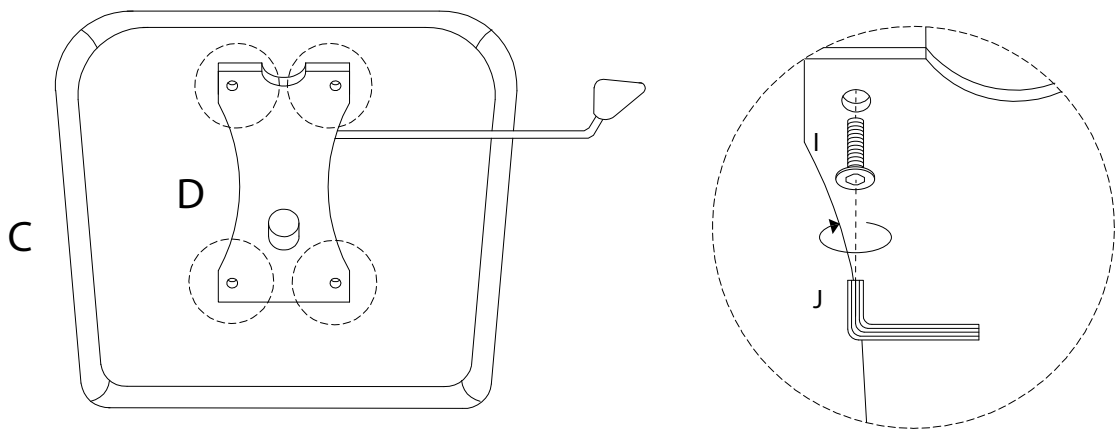
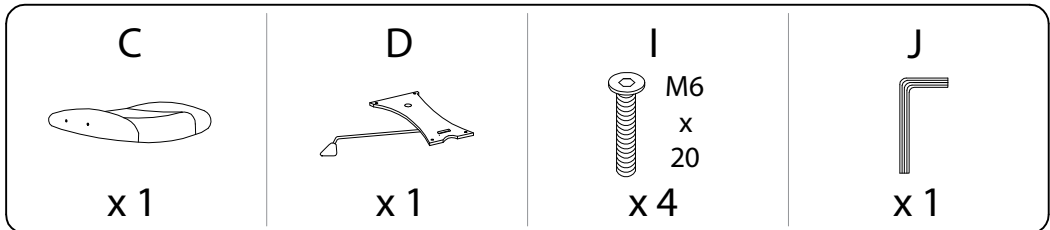

2

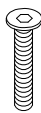
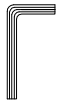

3

A  x 1	B1  x 1	B2  x 1	H  x 8	I  M6 x 20 x 8	J  x 1
--	---	---	---	--	--

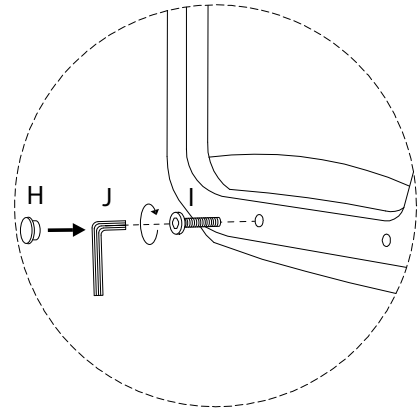
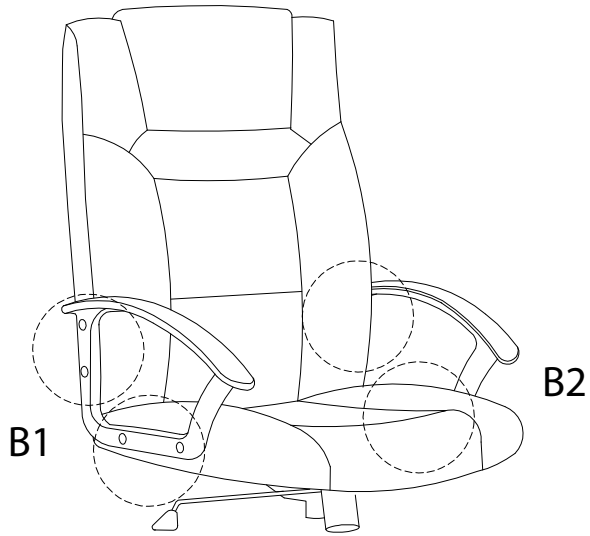

4

