

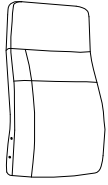

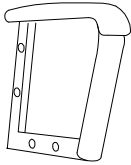



An icon showing an Allen key inside a circle, and a power drill with a diagonal line through it, indicating that a power drill should not be used.	A warning triangle containing an exclamation mark.	A clock face icon.
		30'
An icon showing a rectangular block on a textured surface, and a similar block with a diagonal line through it, indicating that the chair should not be placed on a soft or uneven surface.	A warning triangle containing an exclamation mark.	A simple icon of a person.
		1

A	B	C	D
			
x 1	x 2	x 1	x 1

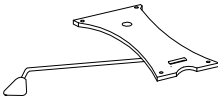
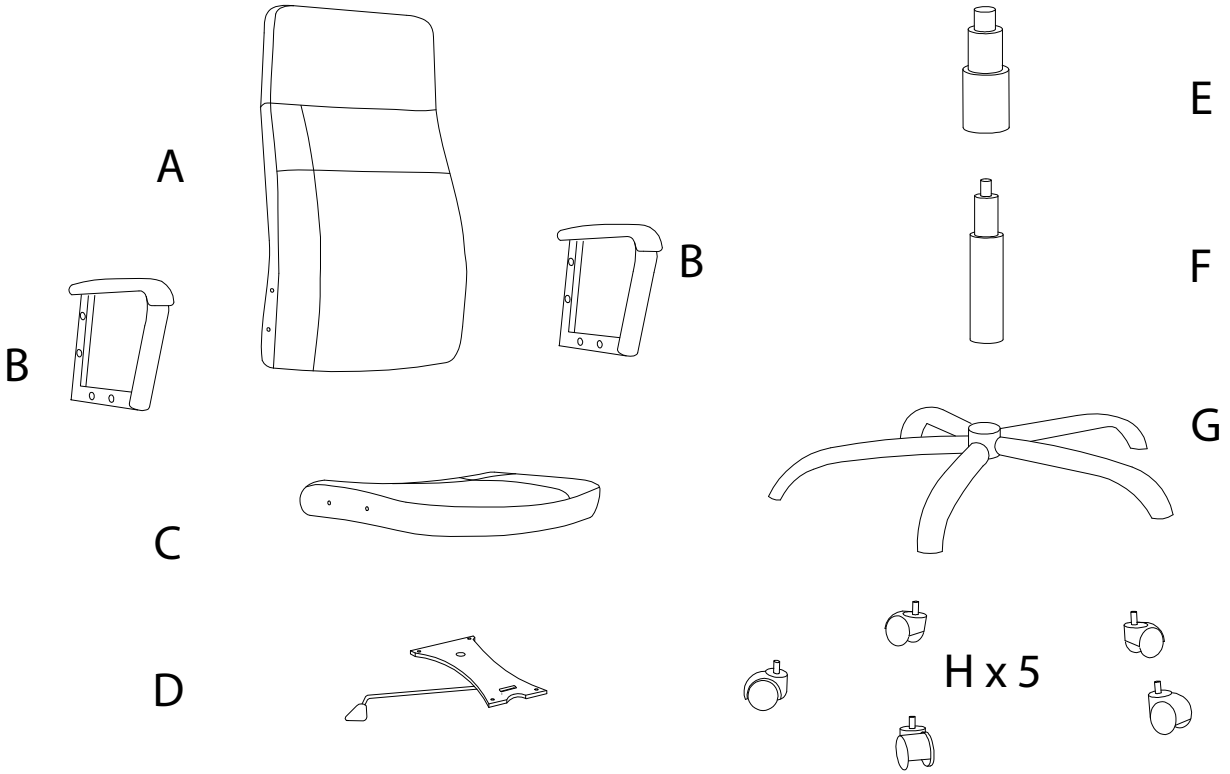
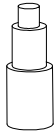

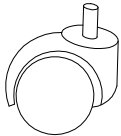
E	F	G	H
			
x 1	x 1	x 1	x 5
I	J	K	L
	 M6 x 20		
x 8	x 12	x 4	x 1

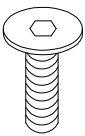
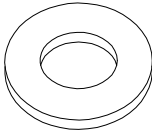
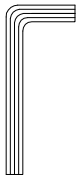

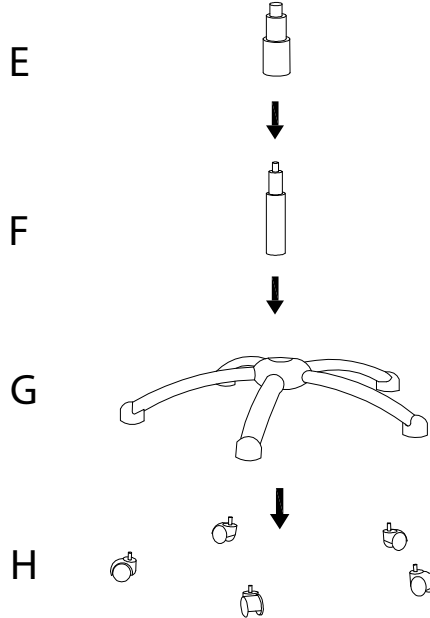
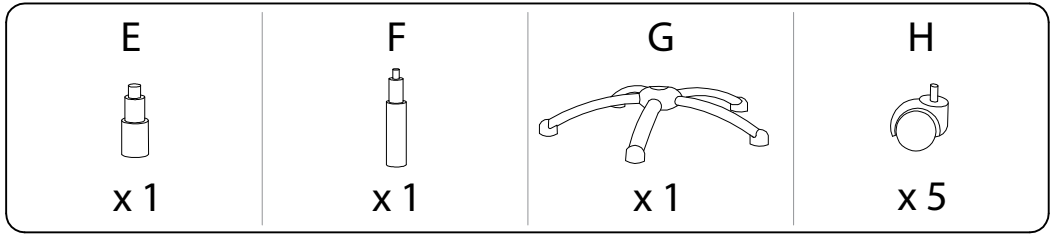
1

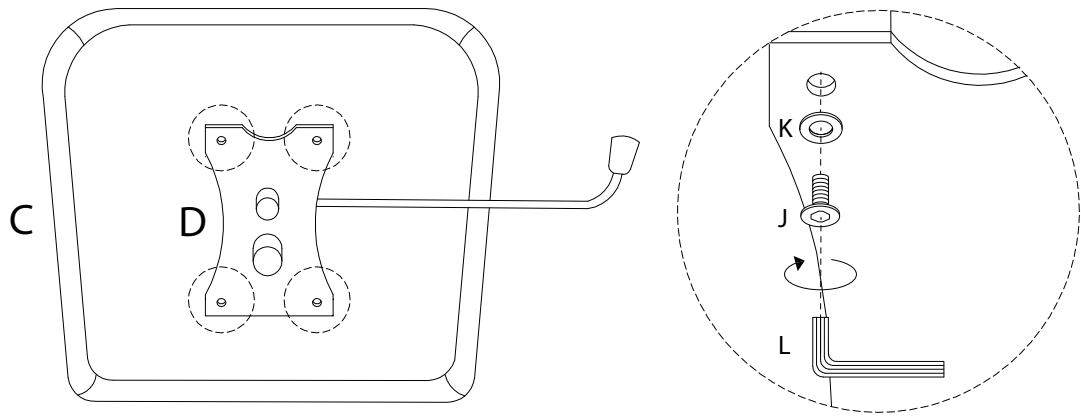
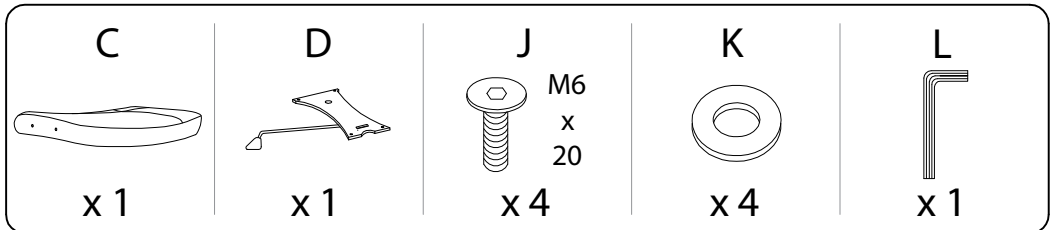

2

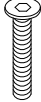
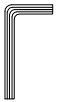

3

A  x 1	B  x 2	I  x 8	J  M6 x 20 x 8	L  x 1
--	--	--	--	--

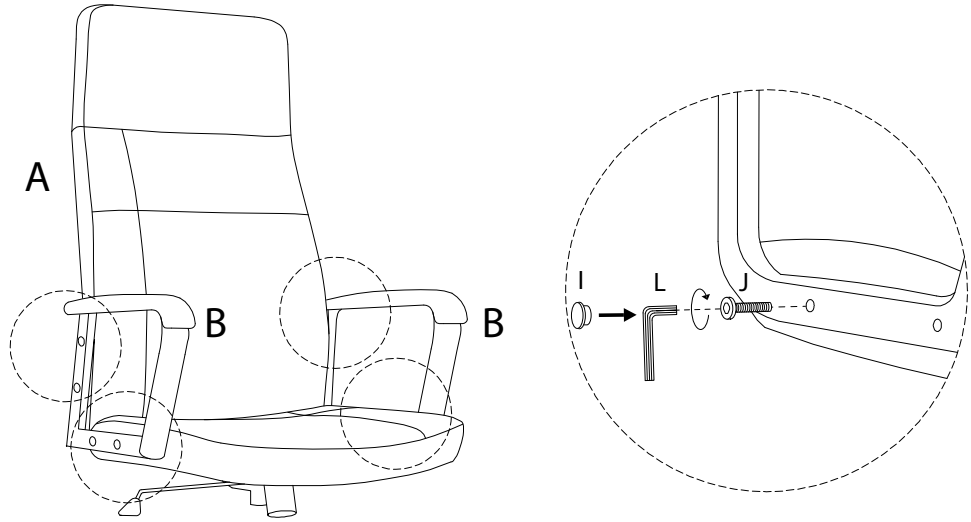

4

