

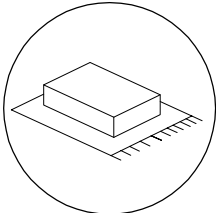

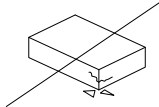







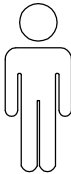
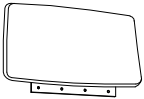
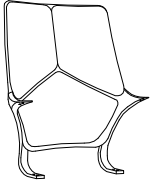
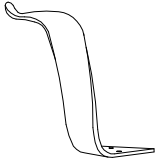

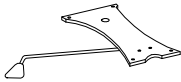
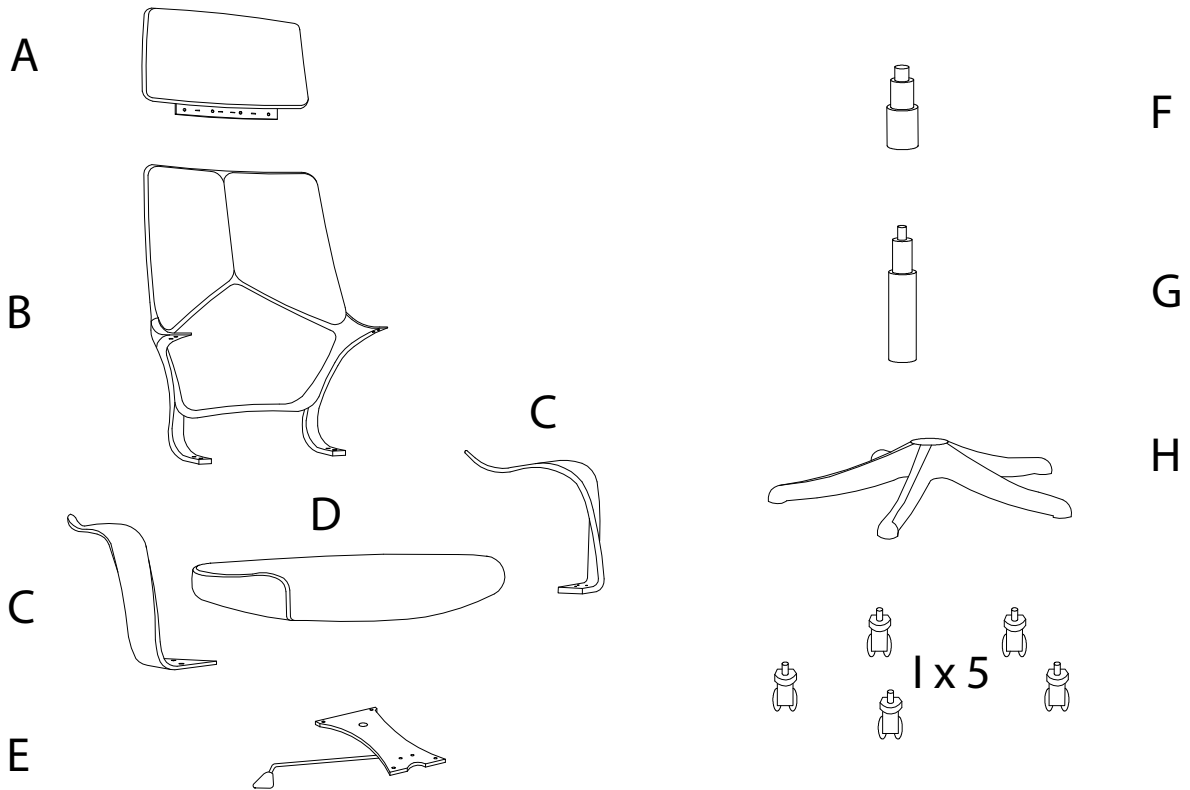
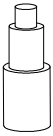
			35'
			
			1

<b>A</b>	<b>B</b>	<b>C</b>	<b>D</b>	<b>E</b>
				
<b>x 1</b>	<b>x 1</b>	<b>x 2</b>	<b>x 1</b>	<b>x 1</b>

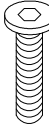
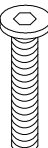
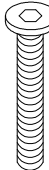

<b>F</b>	<b>G</b>	<b>H</b>	<b>I</b>	<b>J</b>	<b>K</b>
				 M6 x 16	 M6 x 20
<b>x 1</b>	<b>x 1</b>	<b>x 1</b>	<b>x 5</b>	<b>x 4</b>	<b>x 4</b>
<b>L</b>	<b>M</b>	<b>N</b>	<b>O</b>	<b>P</b>	<b>Q</b>
 M6 x 25	 M6 x 35	 5 x 18			
<b>x 6</b>	<b>x 4</b>	<b>x 4</b>	<b>x 1</b>	<b>x 10</b>	<b>x 1</b>

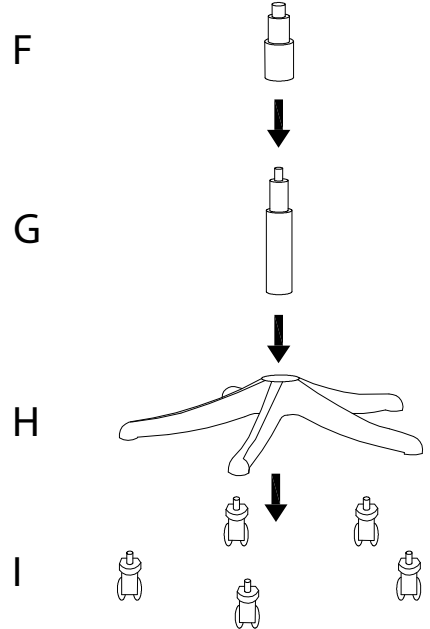
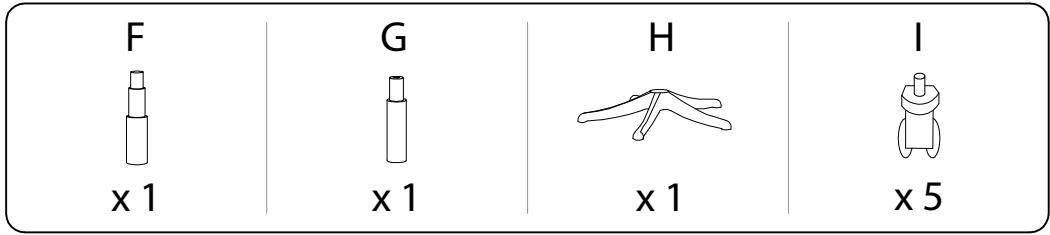
1



2

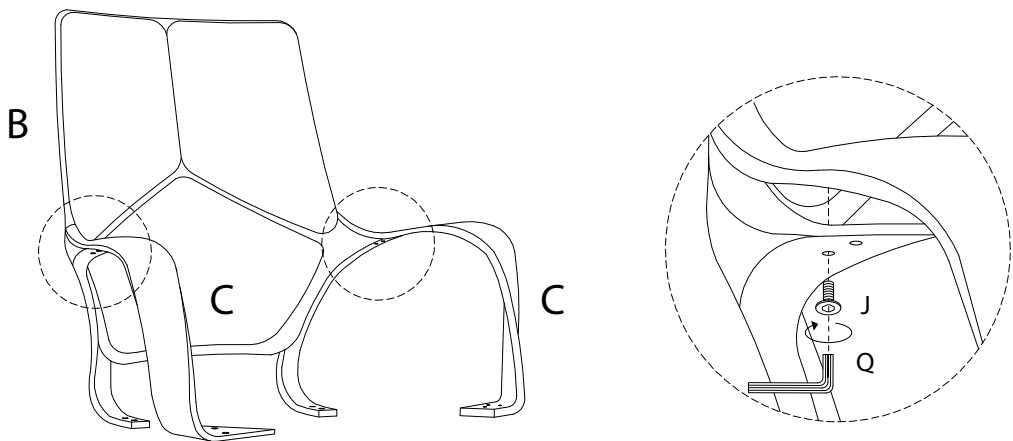
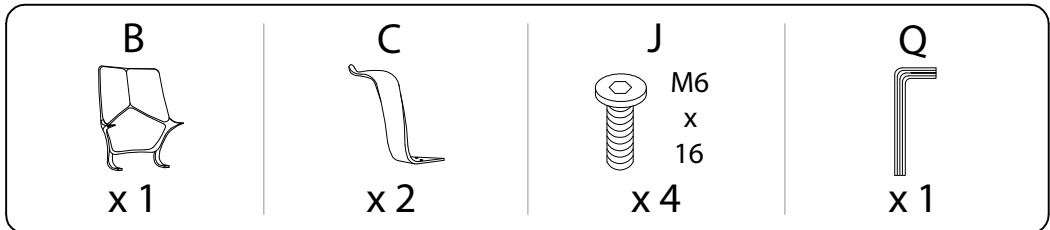

3

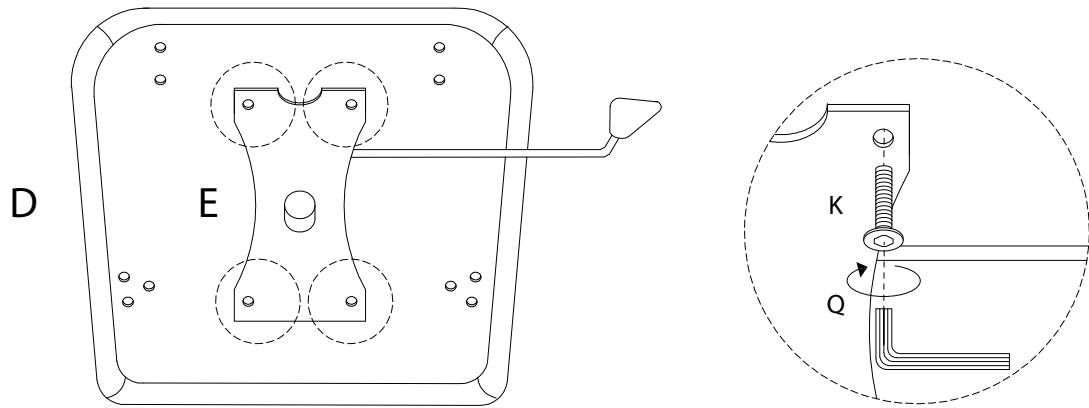
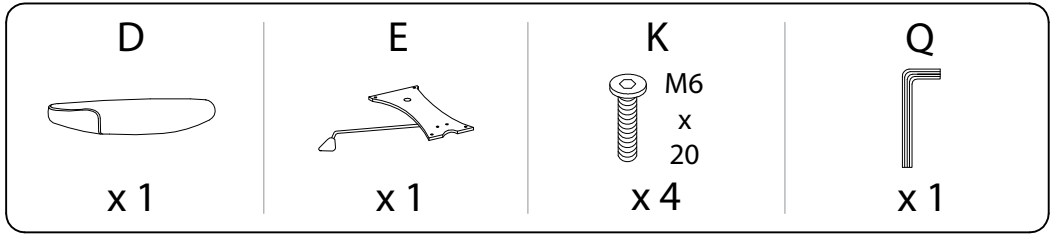

4

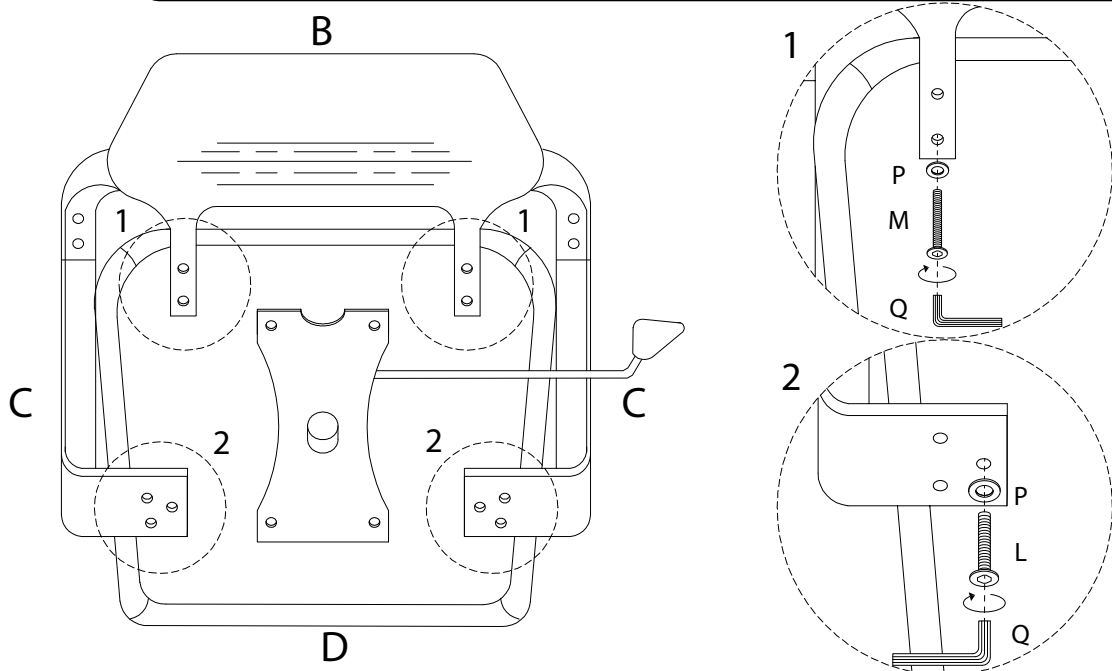
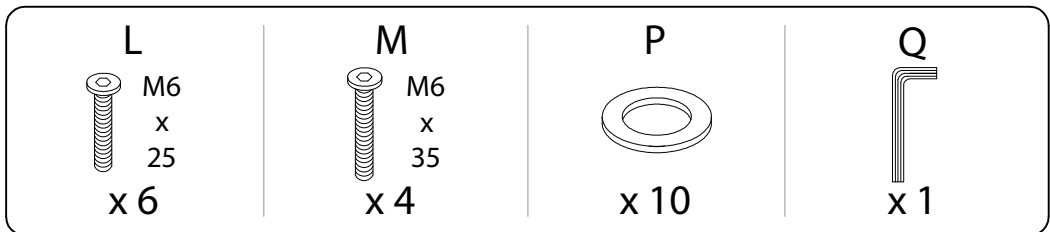

5

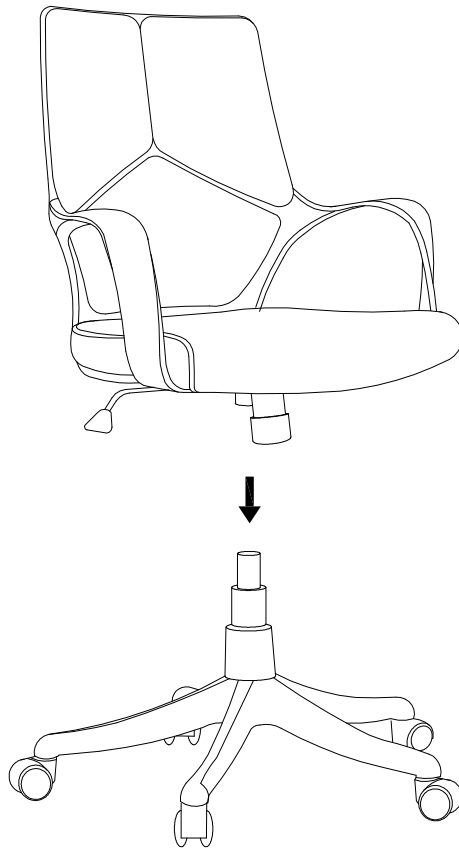

6

