

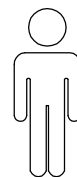

25'

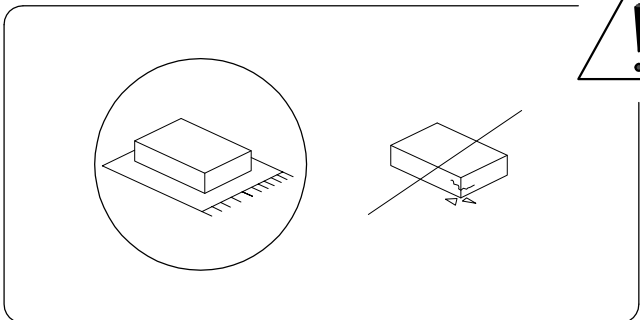

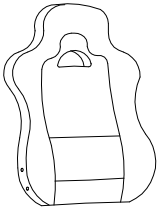

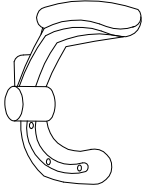

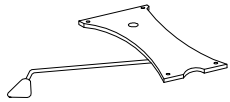

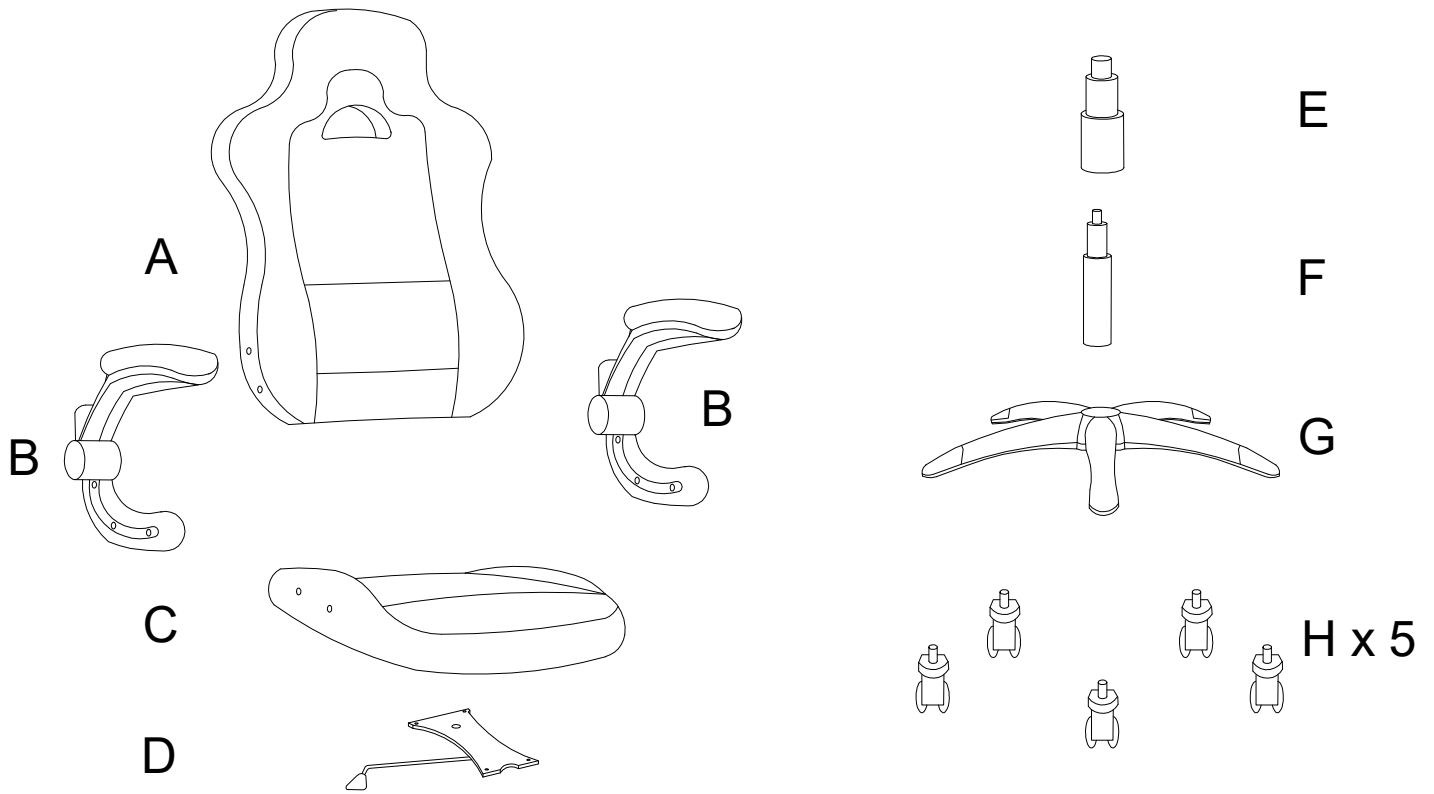
1

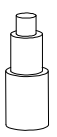
1/4

A  x 1	B  x 2	C  x 1	D  x 1
---	---	--	---

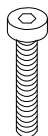

E  x 1	F  x 1	G  x 1	H  x 5
I  x 8	J  M8 x 30 x 8	K  M6 x 20 x 4	L  x 1



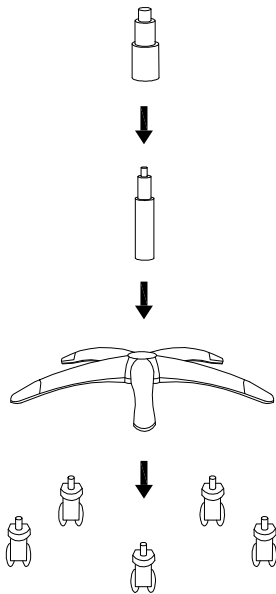
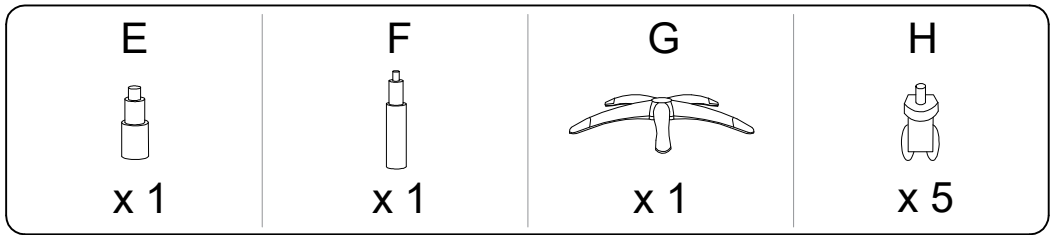

1

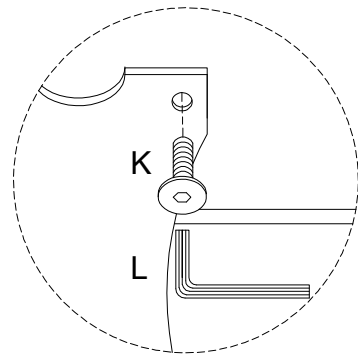
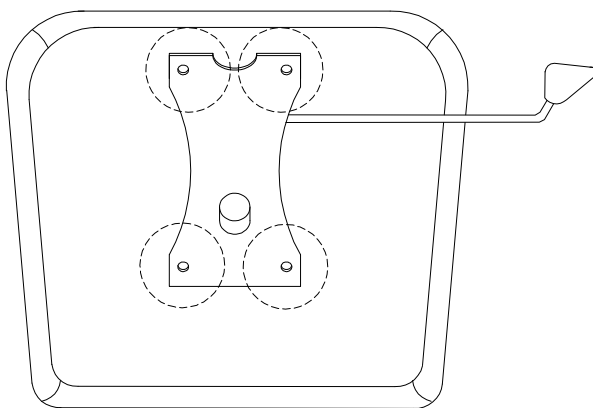
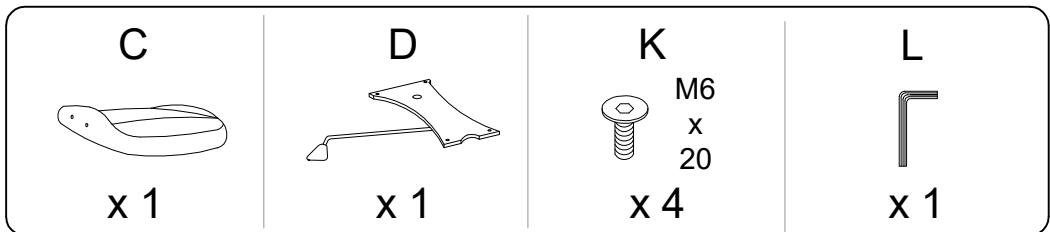

2

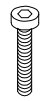

3

<p>B</p>  <p>x 2</p>	<p>I</p>  <p>x 8</p>	<p>J</p>  <p>M8 x 30</p> <p>x 8</p>	<p>L</p>  <p>x 1</p>
--	--	--	--

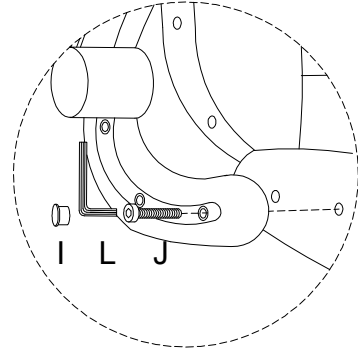
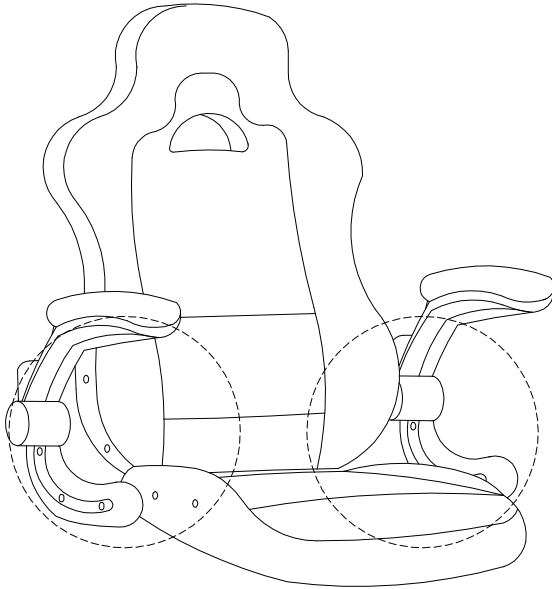

4

