

20'

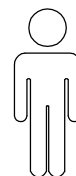
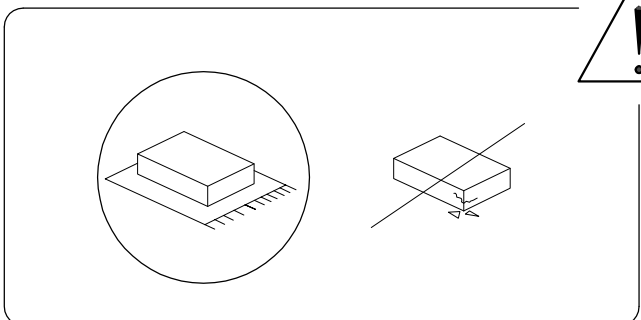

1

1/3

A

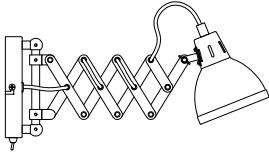

x 1

B

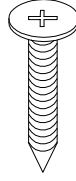

x 2

C

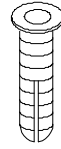

x 2

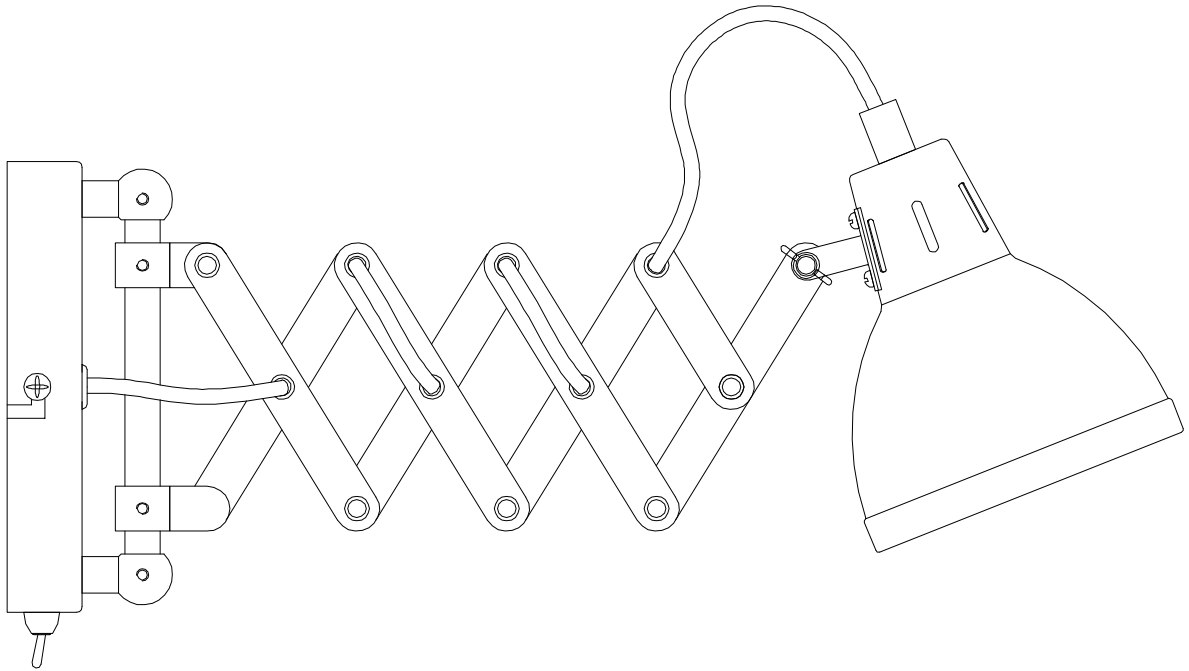

1

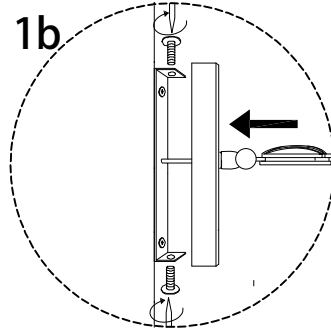
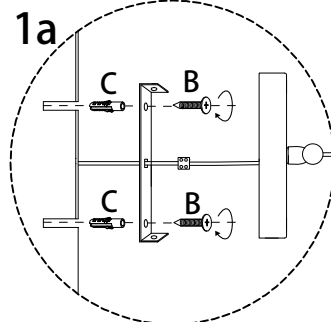
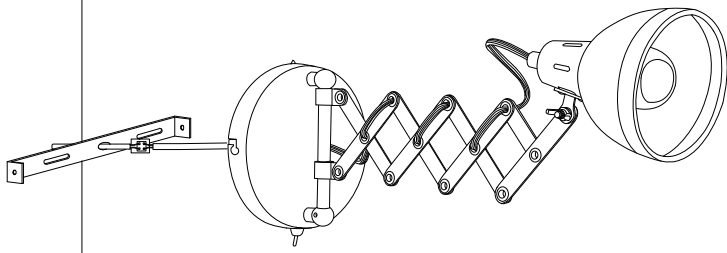
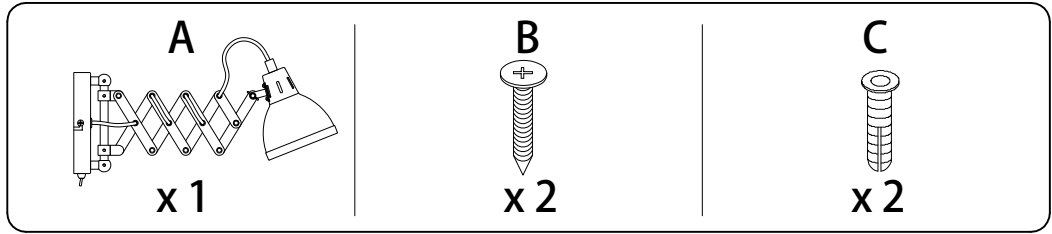

2

