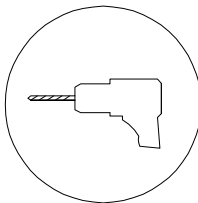
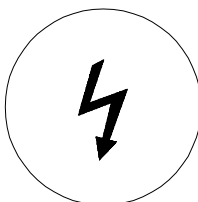
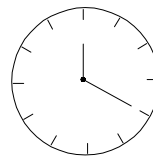

! 

A rectangular box containing a circular icon of a power drill. To the right of the box is a warning triangle containing an exclamation mark. A vertical line connects the bottom of the warning triangle to the top of the box.

! 

A rectangular box containing a circular icon of a lightning bolt. To the right of the box is a warning triangle containing an exclamation mark. A vertical line connects the bottom of the warning triangle to the top of the box.

**20'**



**1**

**1/4**

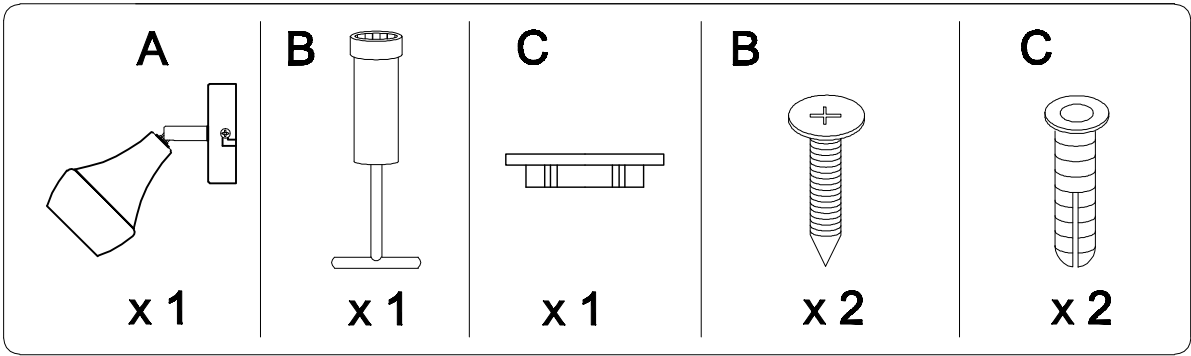

**A**

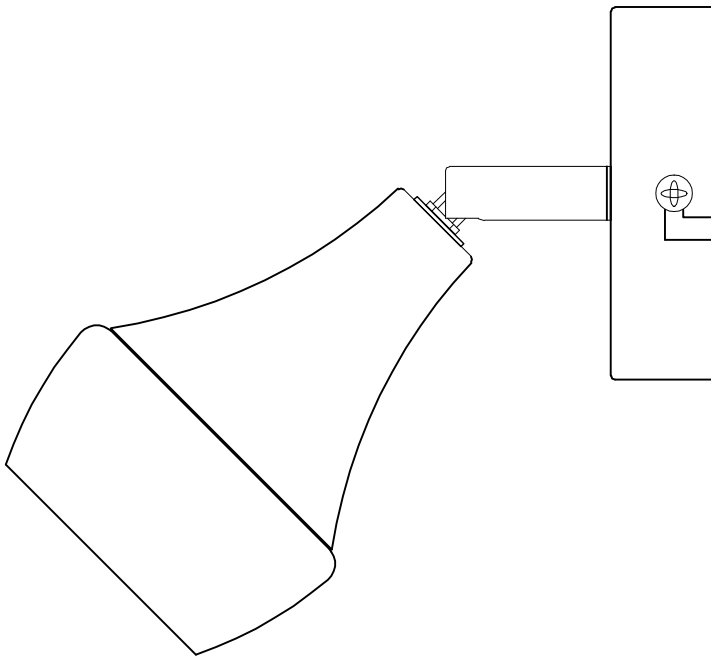

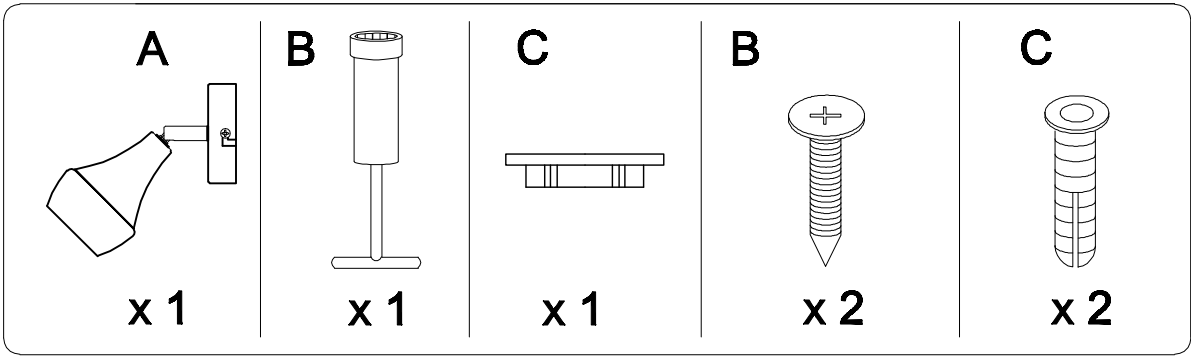

**B**

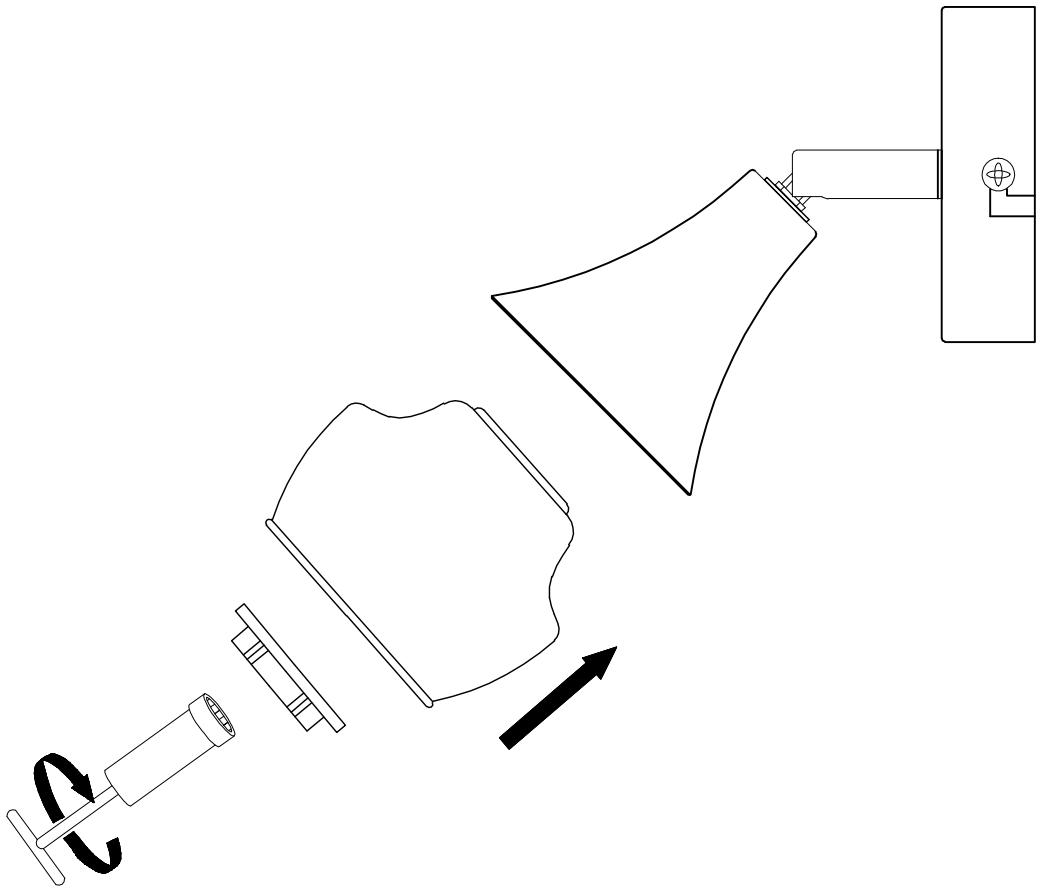

1

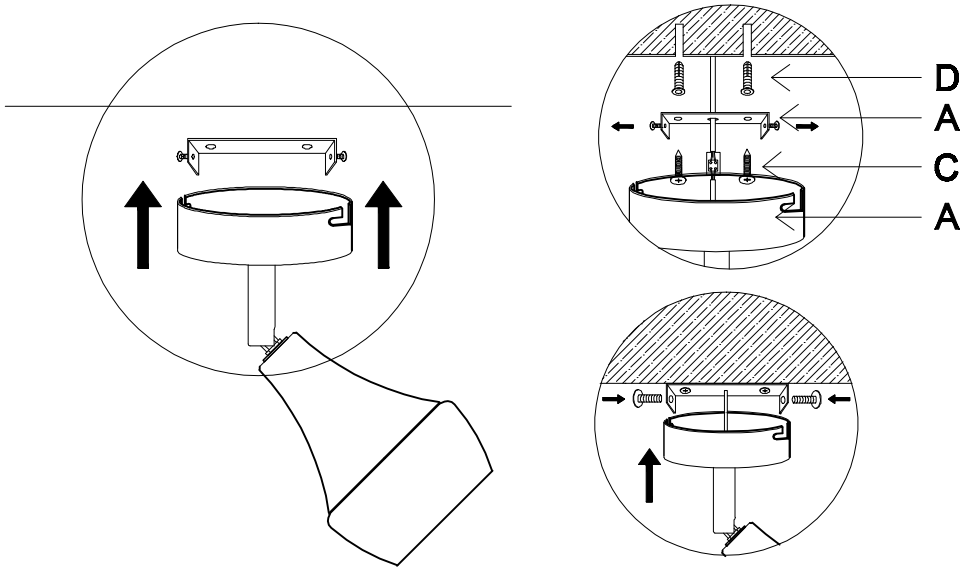
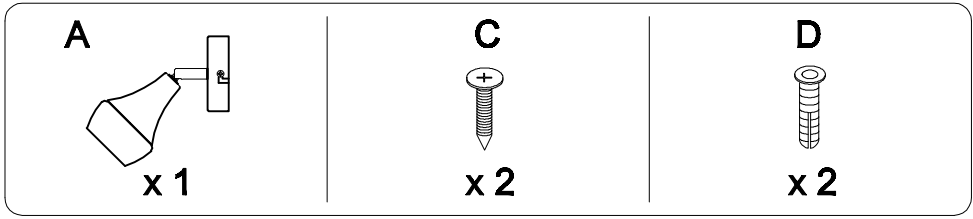

2

