

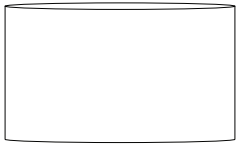



<p>A</p>  <p>x 1</p>	<p>B</p>  <p>x 1</p>	<p>C</p>  <p>x 1</p>
<p>D</p>  <p>x 2</p>	<p>E</p>  <p>M5</p> <p>x 6</p>	<p>F</p>  <p>x 1</p>

!



1

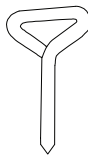
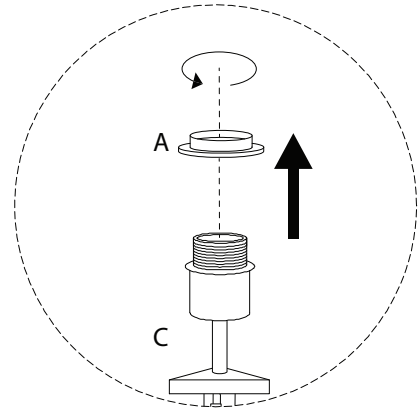
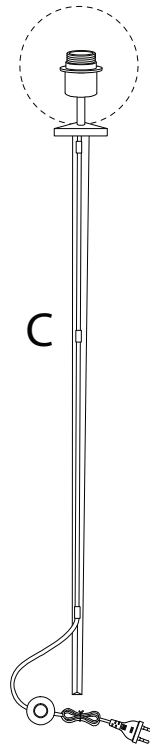
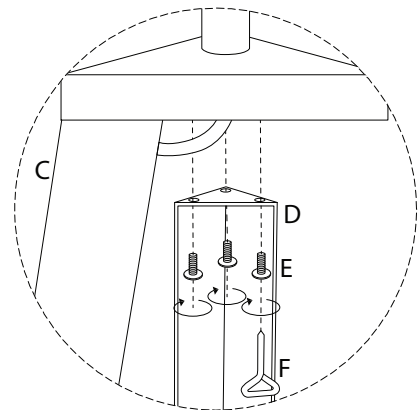
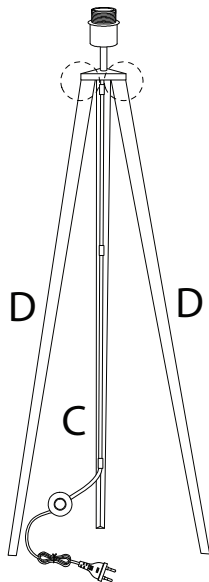
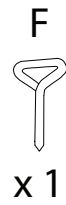

2

A



x 1

B

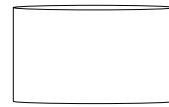

x 1

B

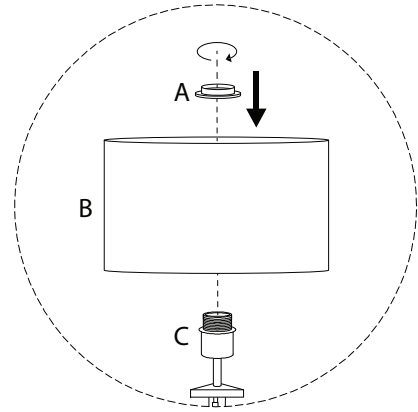
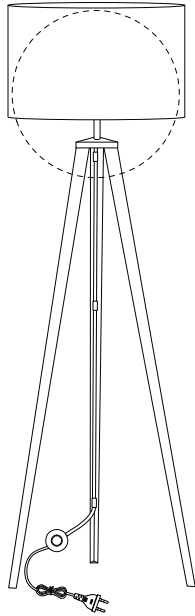

3

