

1/4

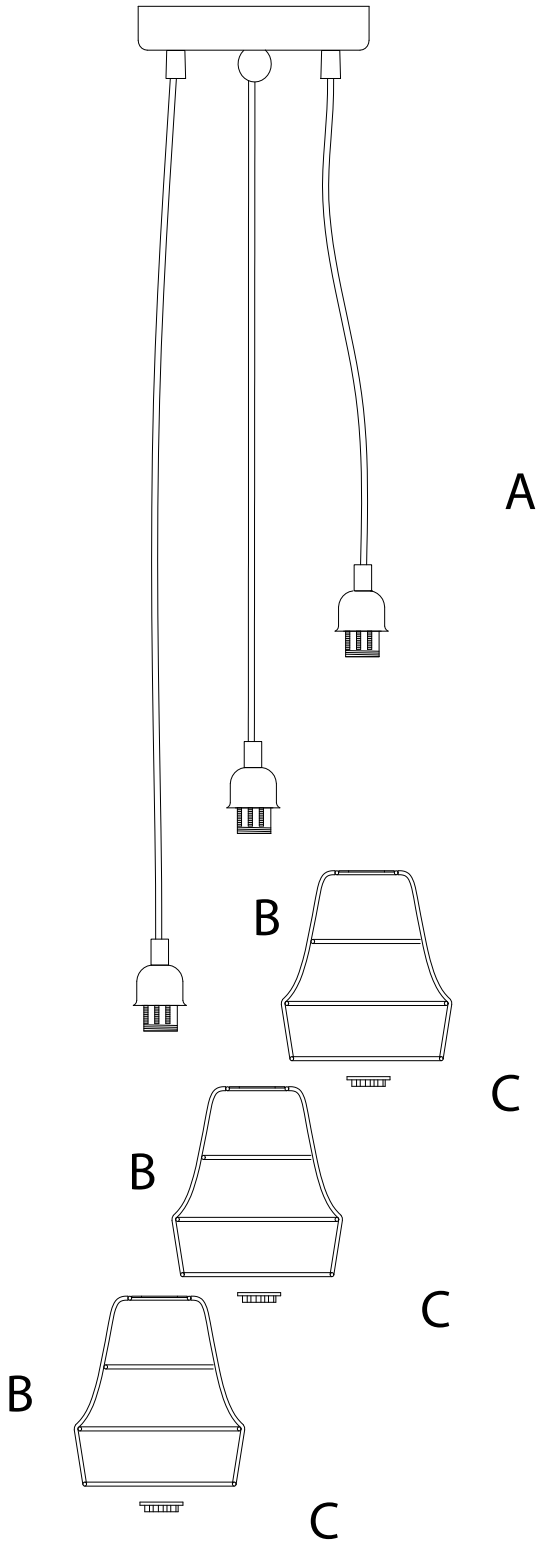

1

A

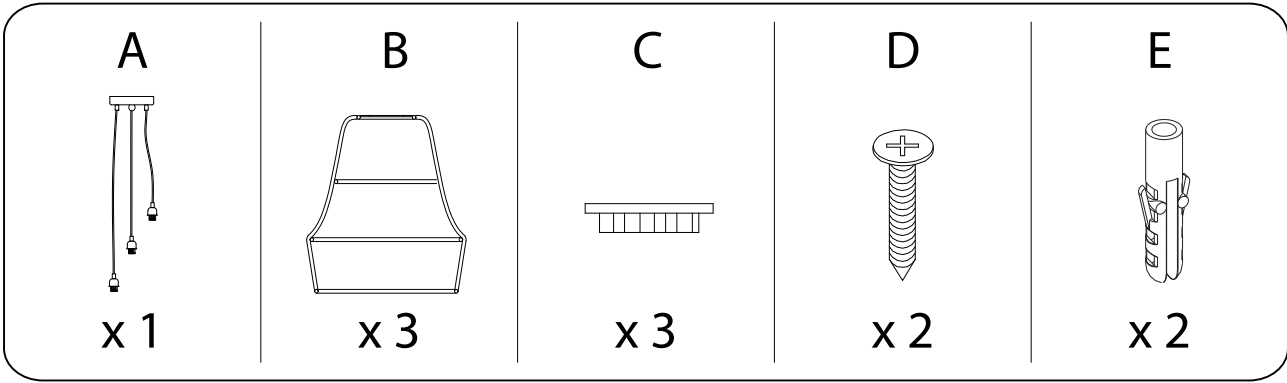

x 1

B



x 3

C

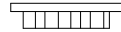

x 3

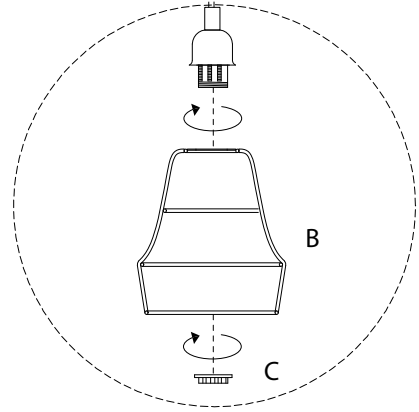
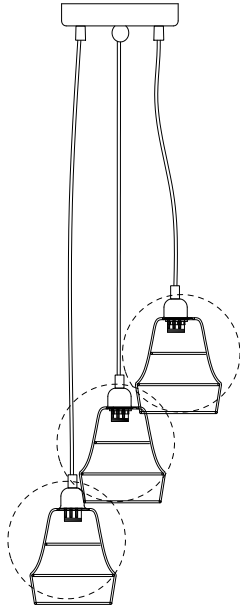

2

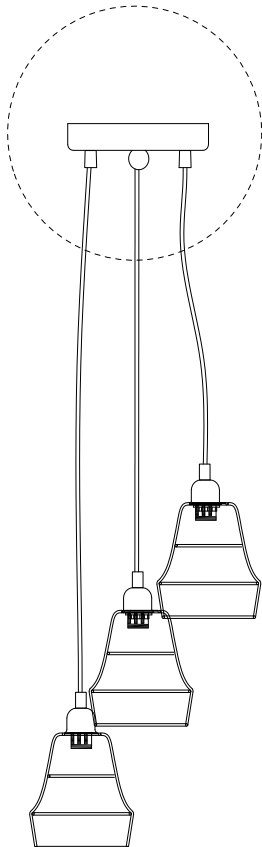

1a

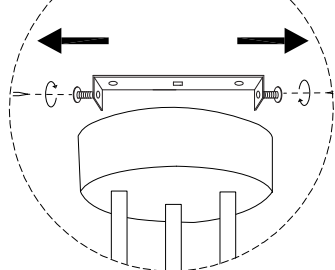

1b

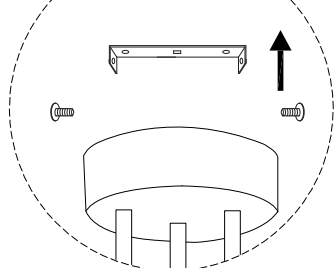

3

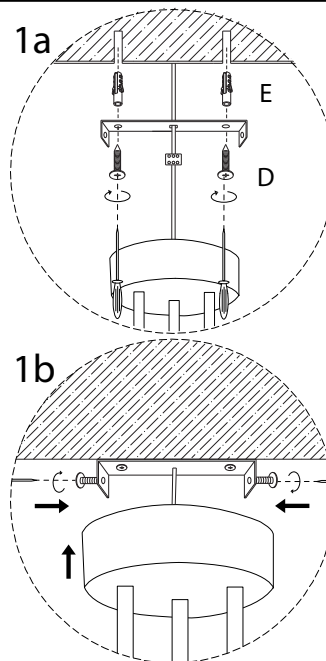
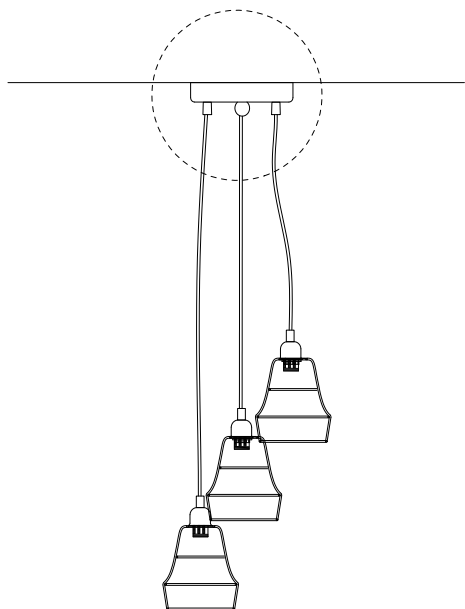
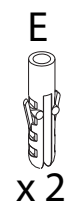
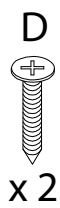

4

