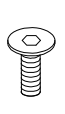
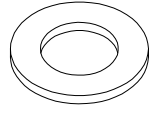
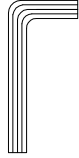
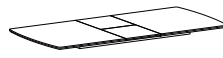
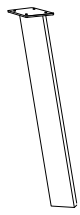
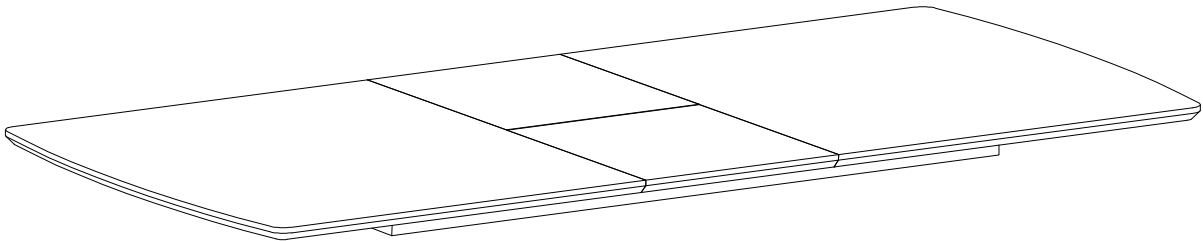

Diagram illustrating assembly instructions and safety warnings:

- Warning 1:** A warning triangle with an exclamation mark is shown next to a circular icon containing an L-shaped bracket and a crossed-out power drill, indicating that a power drill should not be used for this step.
- Warning 2:** A second warning triangle with an exclamation mark is shown next to a circular icon containing a rectangular block on a textured surface and a crossed-out block with a screw, indicating that a screw should not be used on this surface.
- Time:** A clock icon is shown next to the text "20'", indicating a 20-minute assembly time.
- Personnel:** An icon of a person is shown next to the number "2", indicating that two people are required for assembly.

<p>A</p>  <p>M8 x 20</p> <p>x 16</p>	<p>B</p>  <p>x 16</p>	<p>C</p>  <p>x 1</p>	<p>D</p>  <p>x 1</p>	<p>E</p>  <p>x 4</p>
---	--	---	--	---





D

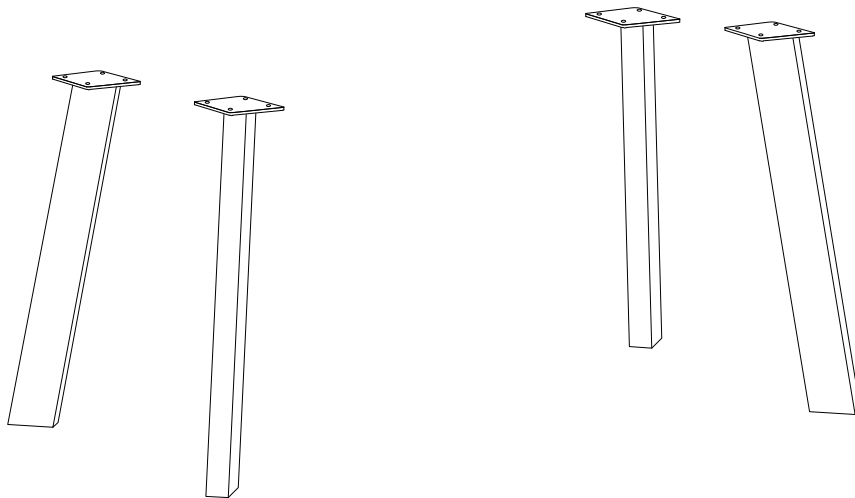

E x 4

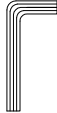

1

A  M8 x 20 x 16	B  x 16	C  x 1	D  x 1	E  x 4
---	---	--	--	--

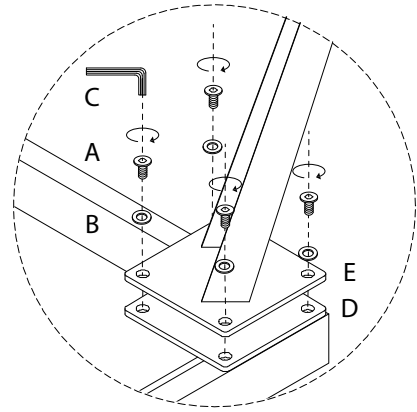
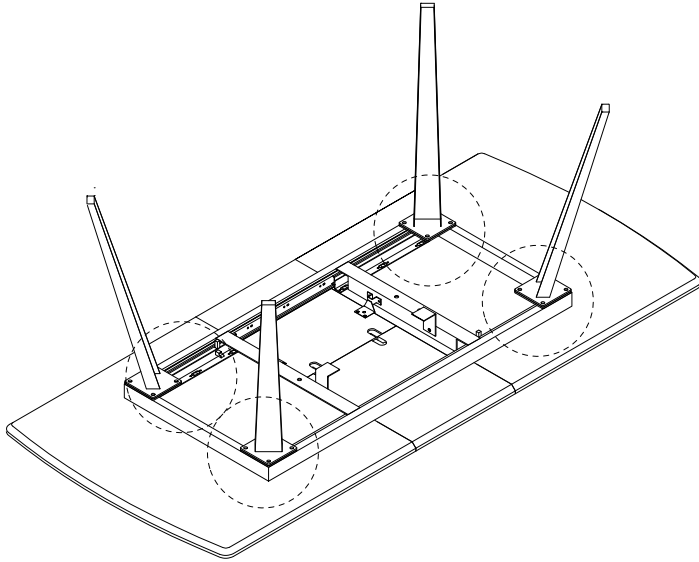

!

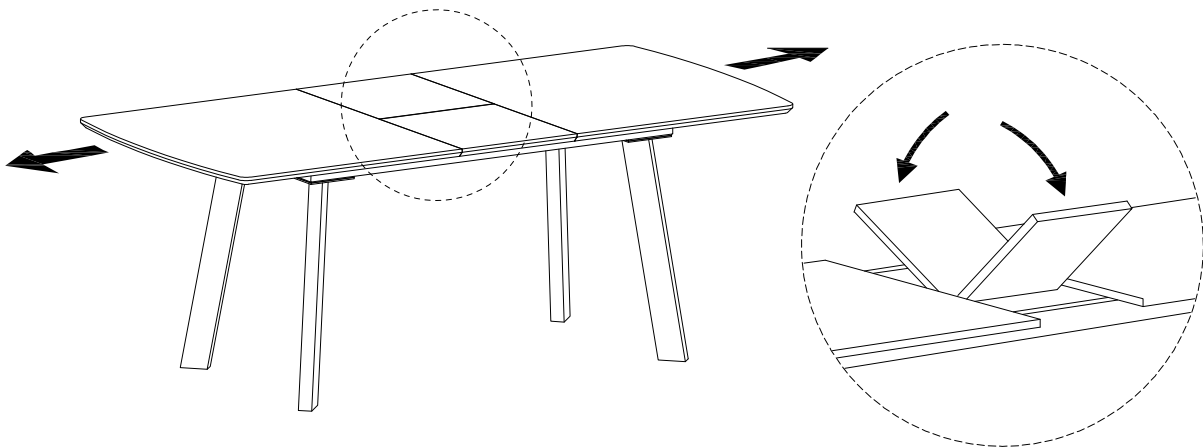

!

