

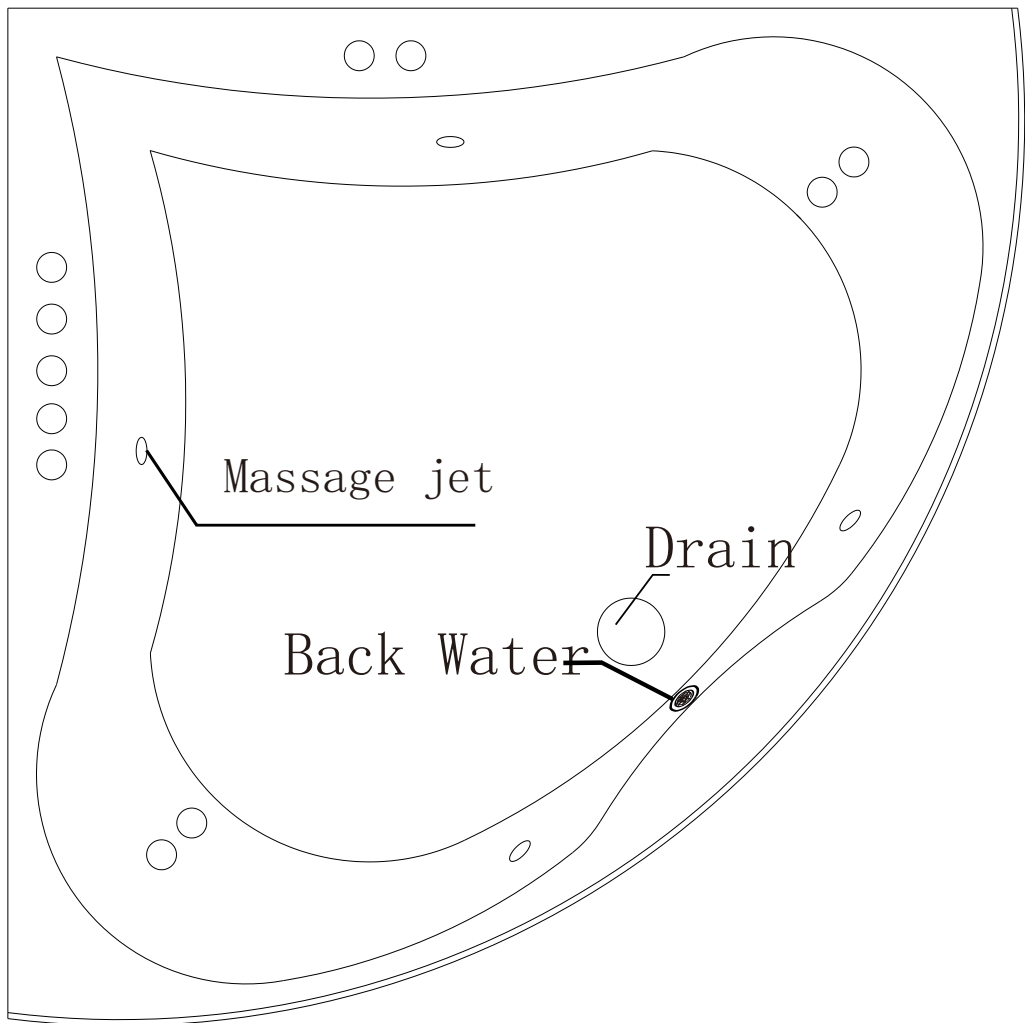

13932

1350x1350x560 mm

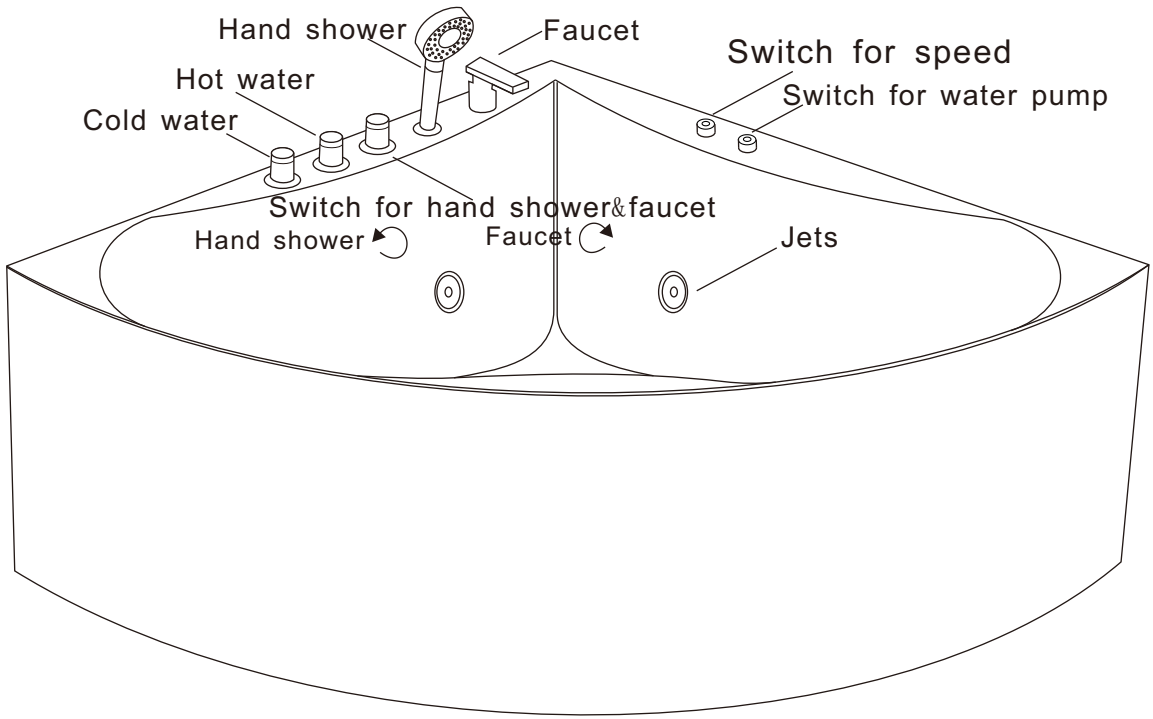

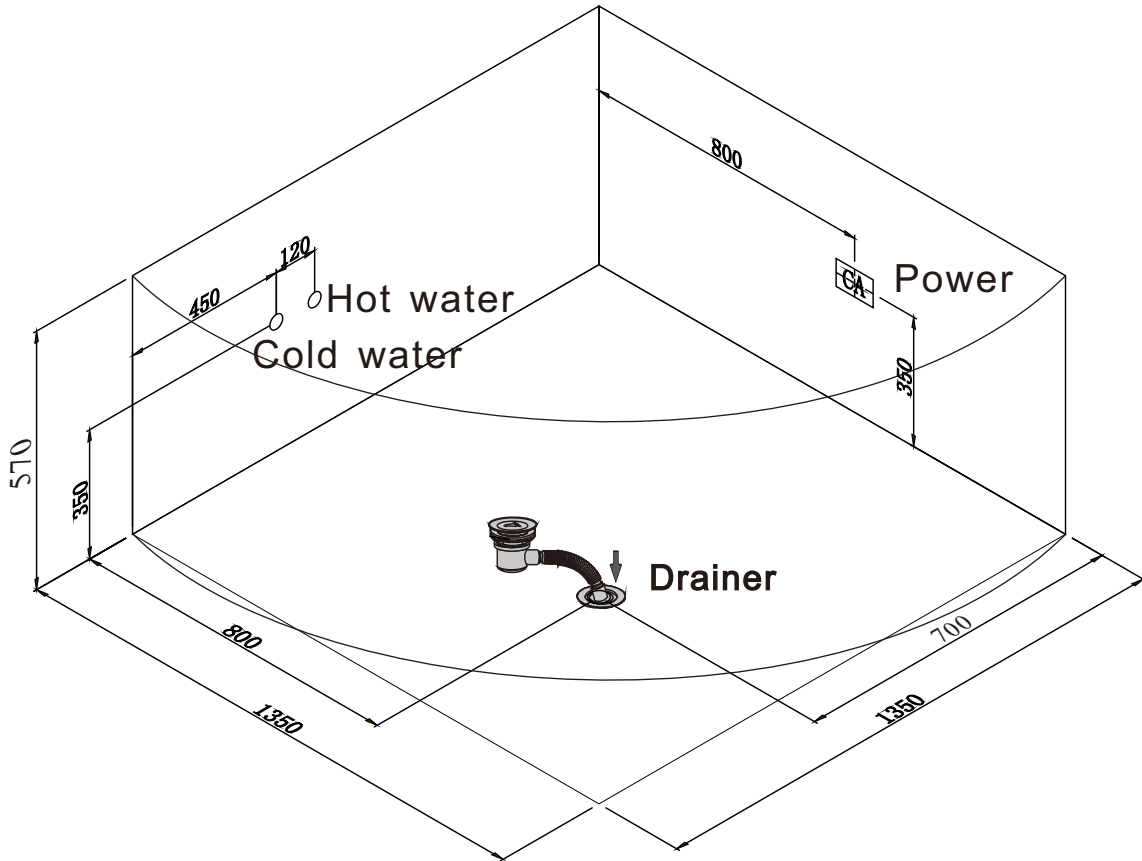



 700w (≈ 3.1A)

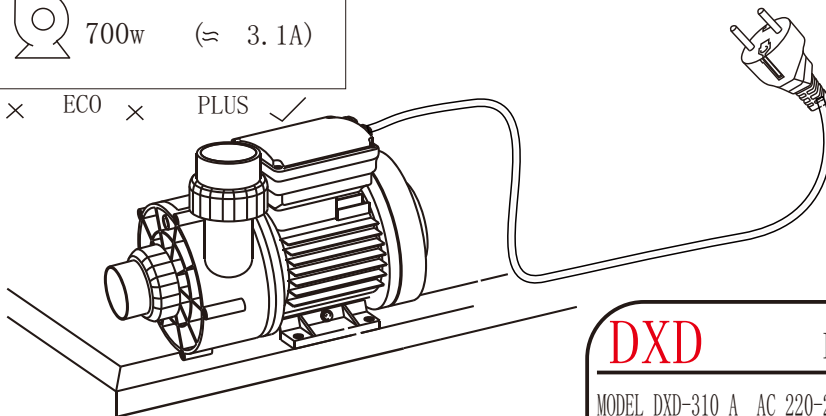

VITAL × ECO × PLUS ✓

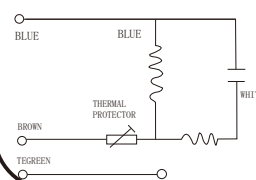

DXD PUMP

MODEL DXD-310 A AC 220-240V 50Hz 700W CLASS B IPX5
 MAX WATER TEMPERATURE 50C 15u F/450V Hmin 1m



 Mround properly!
 Do Not Start Pump
 Without Water!

