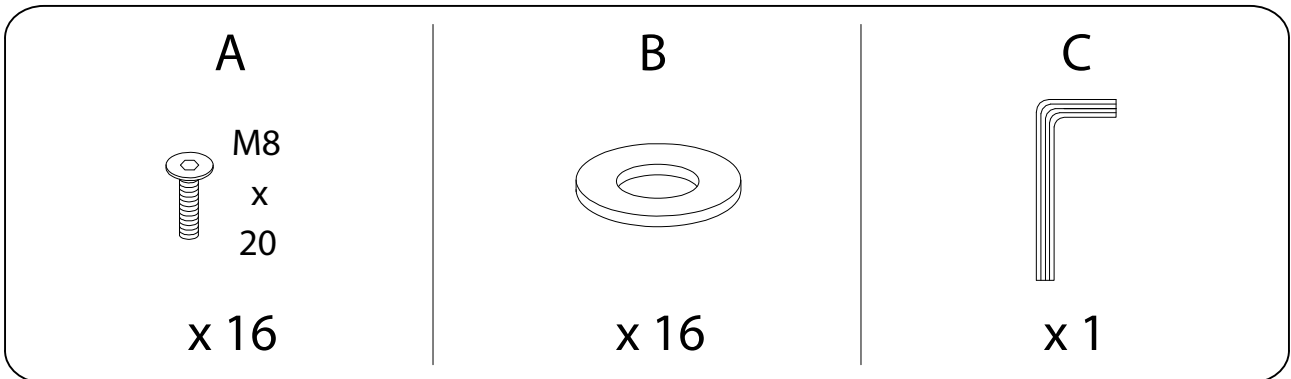
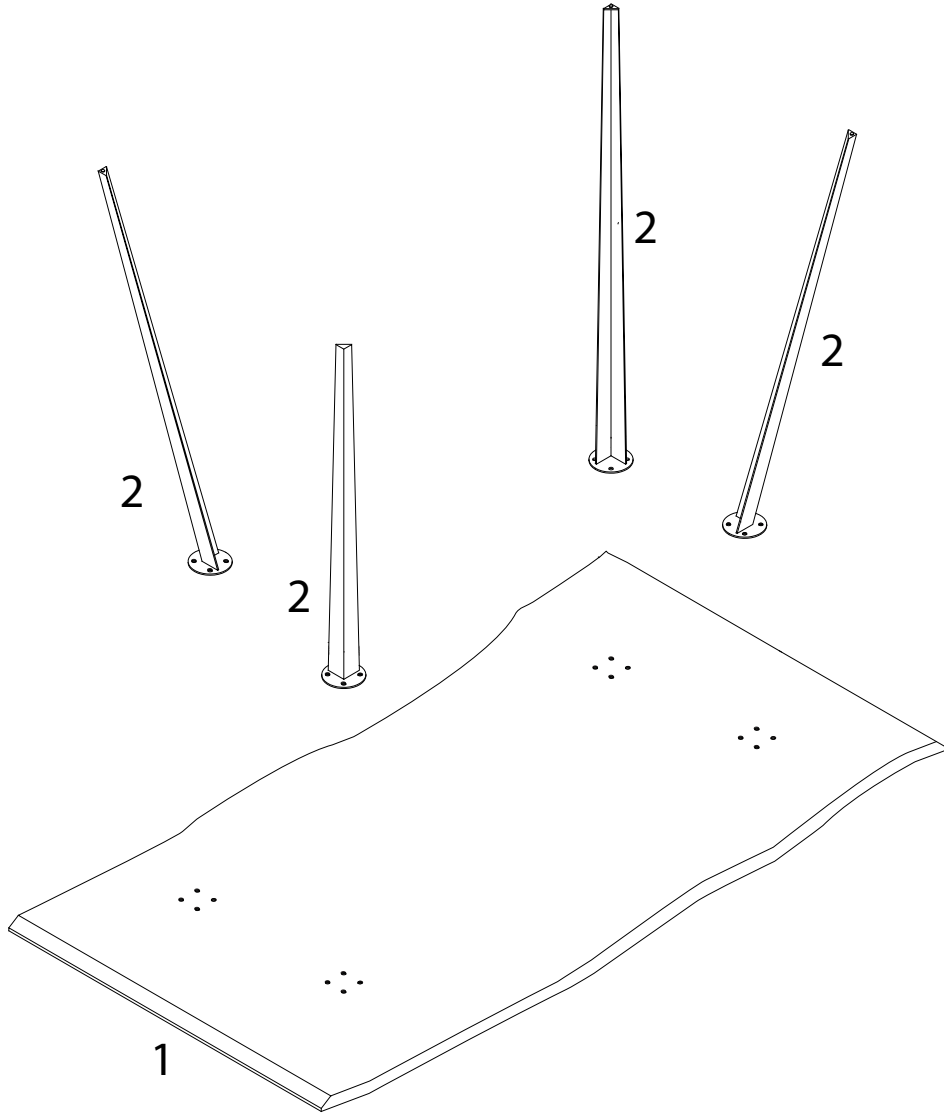
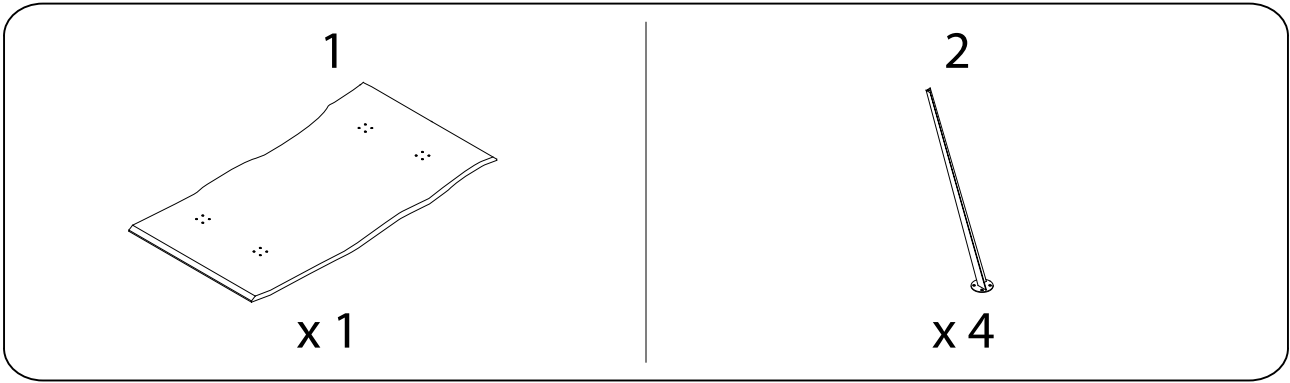
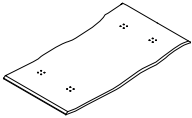





Diagram illustrating assembly instructions and safety warnings:

- Warning 1:** A warning triangle with an exclamation mark is shown next to a box containing an L-shaped bracket and a power drill with a slash through it, indicating that a power drill should not be used for this step.
- Warning 2:** A second warning triangle with an exclamation mark is shown next to a box containing a rectangular block being placed on a textured surface and a diagram showing the block being pushed down, indicating a specific placement or force requirement.
- Time:** A clock icon is shown next to the text "20'", indicating a 20-minute assembly time.
- Personnel:** A person icon is shown next to the number "2", indicating that two people are required for assembly.



1

<p>1</p>  <p>x 1</p>	<p>2</p>  <p>x 4</p>	<p>A</p>  <p>M8 x 20</p> <p>x 16</p>	<p>B</p>  <p>x 16</p>	<p>C</p>  <p>x 1</p>
---	---	---	--	---

