

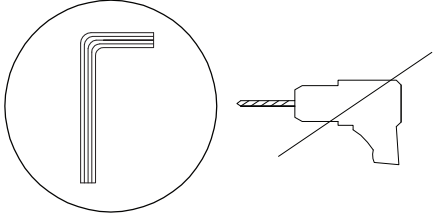

POWELL







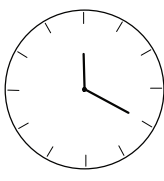
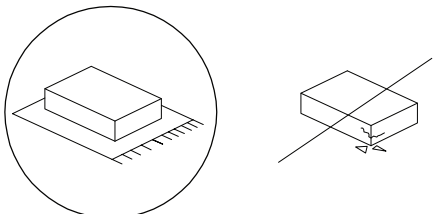
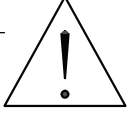
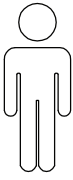
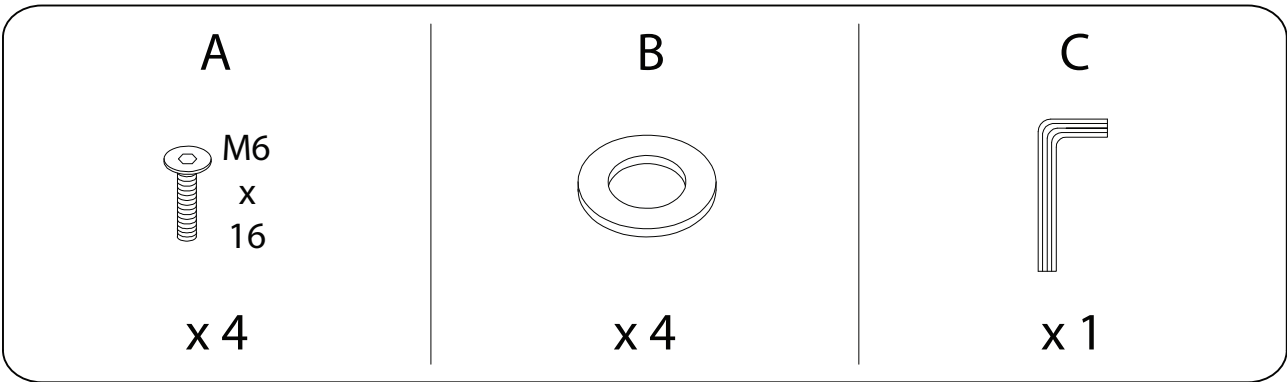
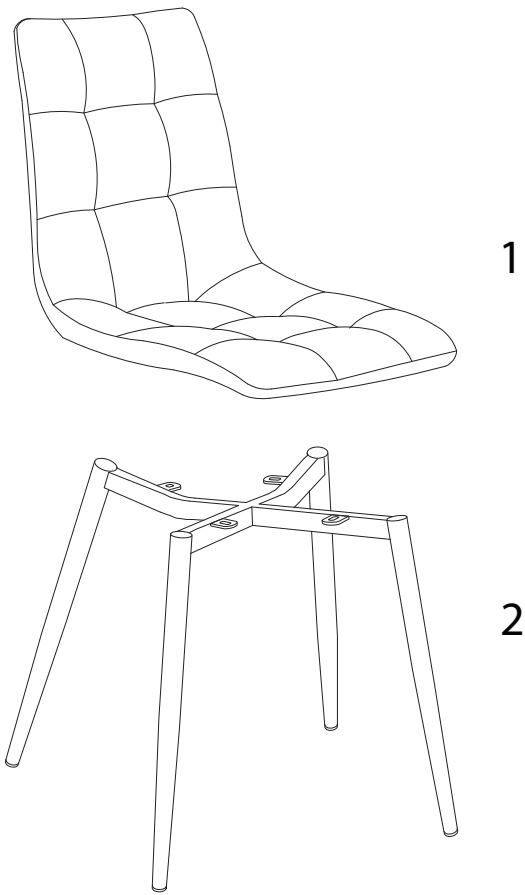
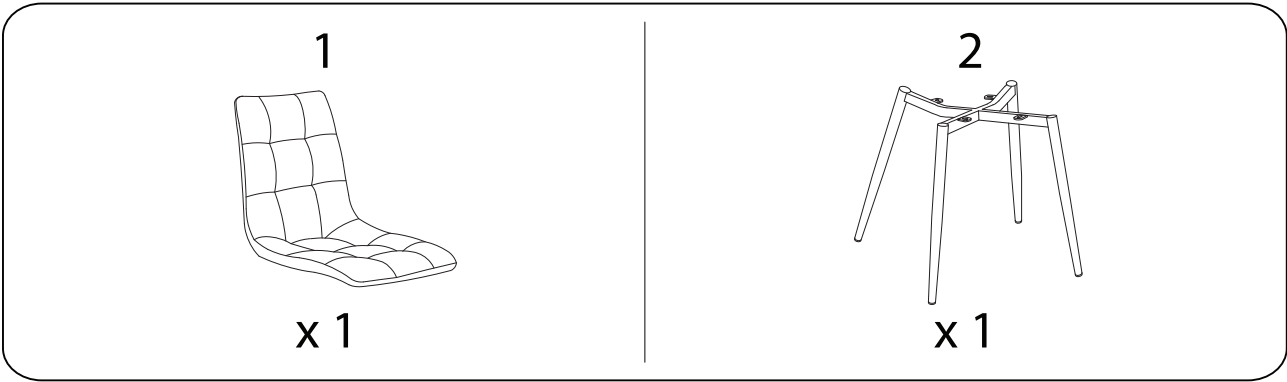

		
		
		20'
		1

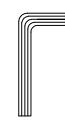

1

<p>1</p>  <p>x 1</p>	<p>2</p>  <p>x 1</p>	<p>A</p>  <p>M6 x 16</p> <p>x 4</p>	<p>B</p>  <p>x 4</p>	<p>C</p>  <p>x 1</p>
---	---	--	---	---

