



Assembly instructions for the table, including tool requirements, time, and personnel.

**Tools:** A wrench is shown in a circle, and a power drill is shown with a diagonal line through it, indicating it is not required.





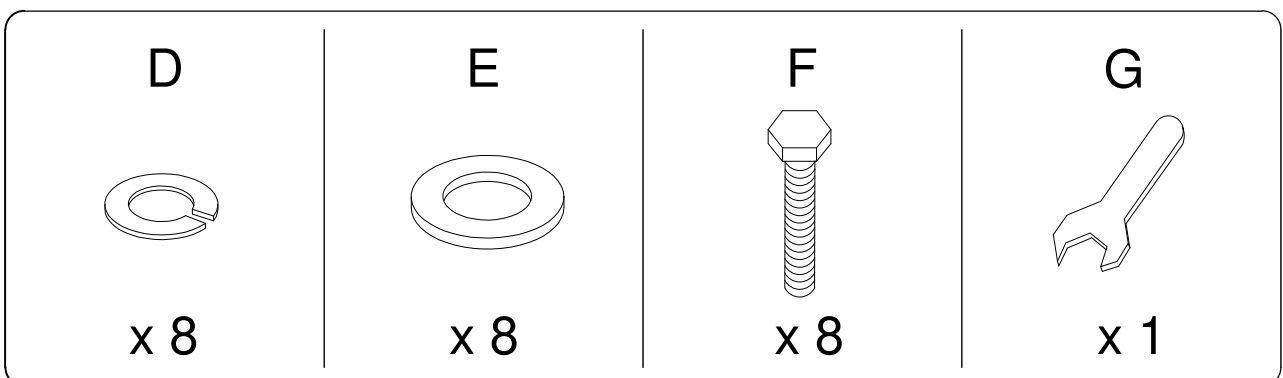
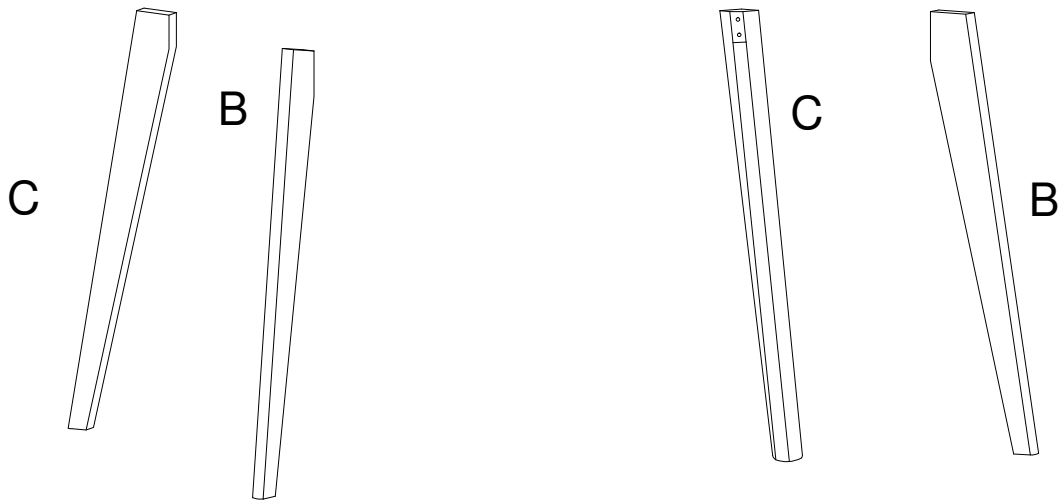
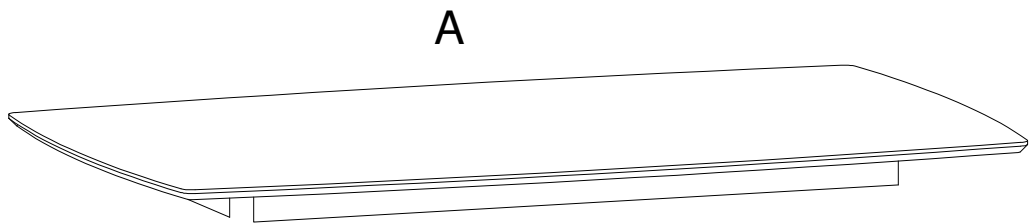
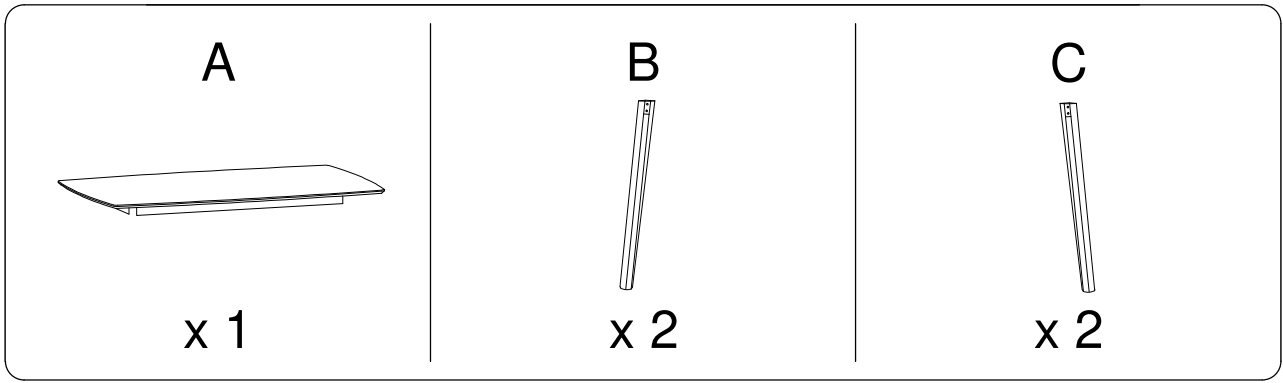

**Time:** A clock icon is shown above the number **15'**, indicating the estimated assembly time.

**Personnel:** A person icon is shown above the number **1**, indicating the number of people required for assembly.

**Warnings:** Two warning triangles (exclamation marks) are shown. The first is connected to the tool icons, and the second is connected to the person icon, indicating safety instructions.

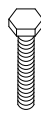

1

<b>A</b>  x 1	<b>B</b>  x 2	<b>C</b>  x 2	<b>D</b>  x 8	<b>E</b>  x 8	<b>F</b>  x 8	<b>G</b>  x 1
--	--	--	--	---	--	--

