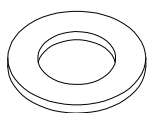



Diagram illustrating assembly instructions and safety warnings:

- Warning 1:** A warning triangle with an exclamation mark is shown next to a box containing an L-shaped bracket and a power drill with a slash through it, indicating that a power drill should not be used for this step.
- Warning 2:** A second warning triangle with an exclamation mark is shown next to a box containing a rectangular block being placed on a surface and a diagram showing a screw being inserted into the block, indicating a specific assembly step.
- Time:** A clock icon is shown next to the text "30'", indicating the estimated assembly time.
- Personnel:** An icon of a person is shown next to the number "2", indicating that two people are required for assembly.

A



x 16

B

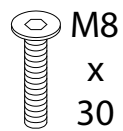

x 16

D

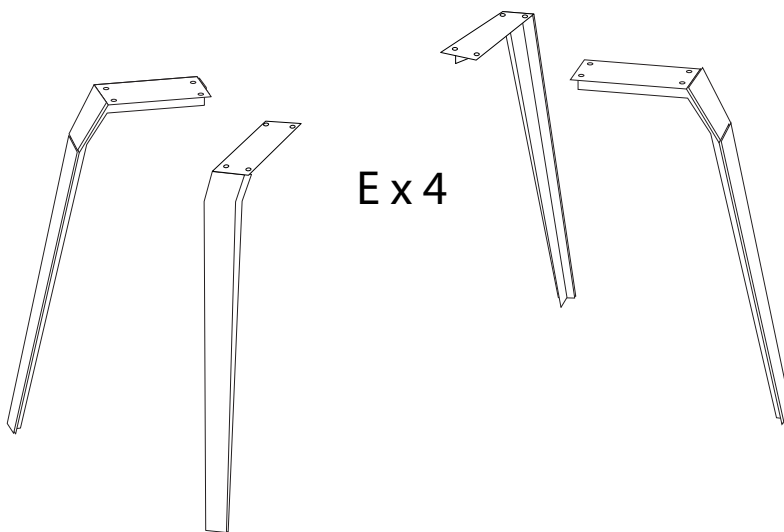
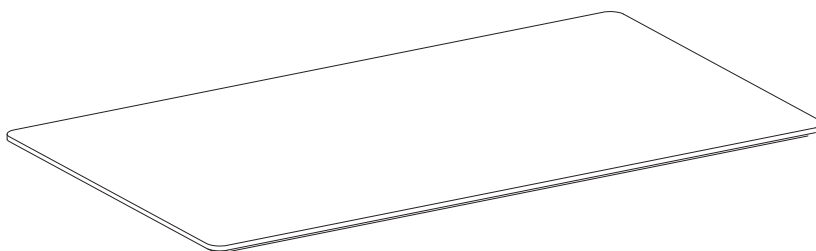

C

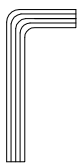

x 1

D





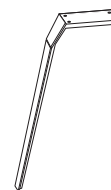

x 1

E

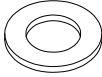

x 4

1

<p>A</p>  <p>x 16</p>	<p>B</p>  <p>M8 x 30</p> <p>x 16</p>	<p>C</p>  <p>x 1</p>	<p>D</p>  <p>x 1</p>	<p>E</p>  <p>x 4</p>
--	---	---	---	---

