

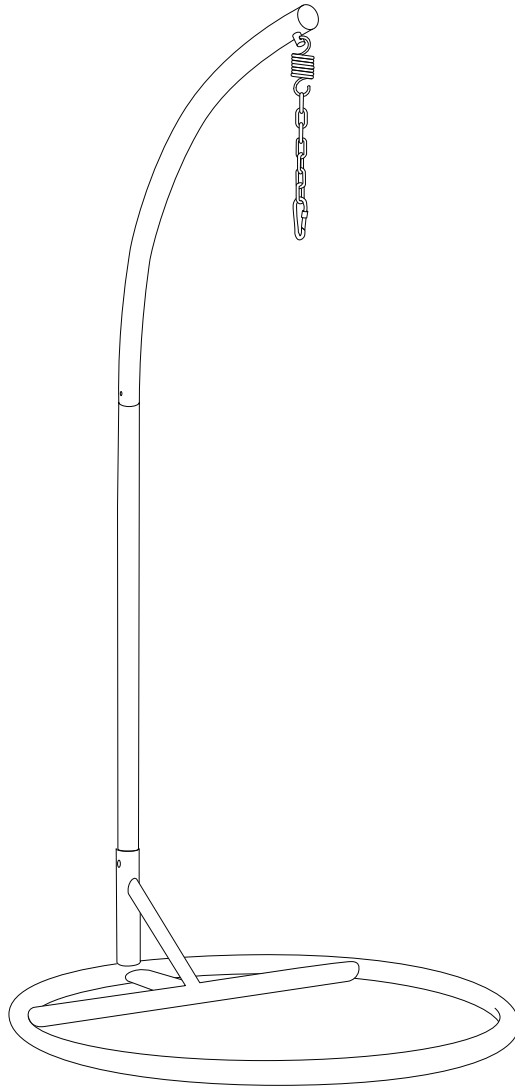

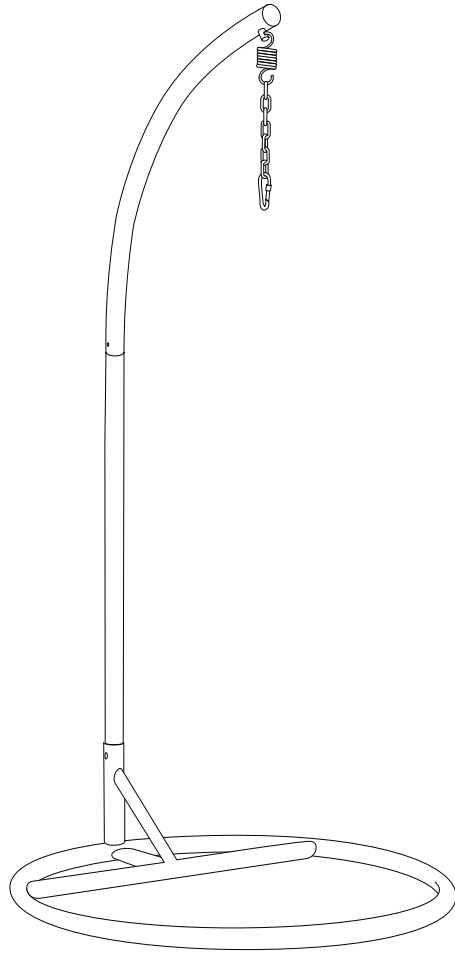

STAN

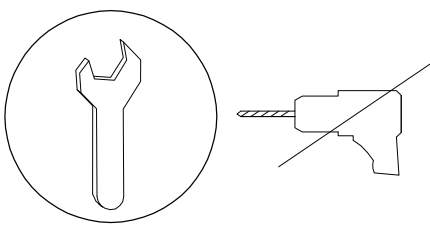

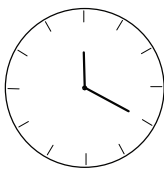
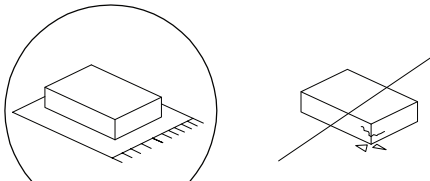

		
		
<p>20'</p>		<p>2</p>

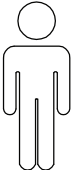
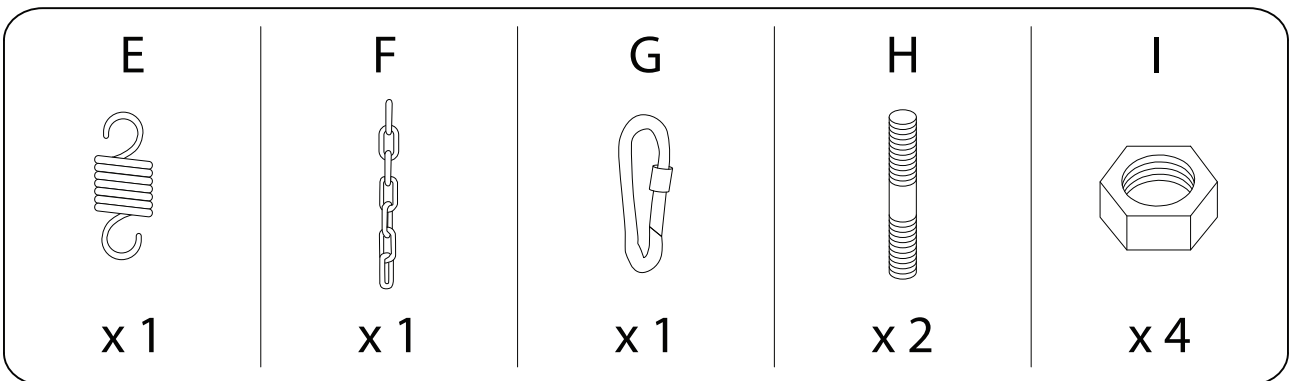
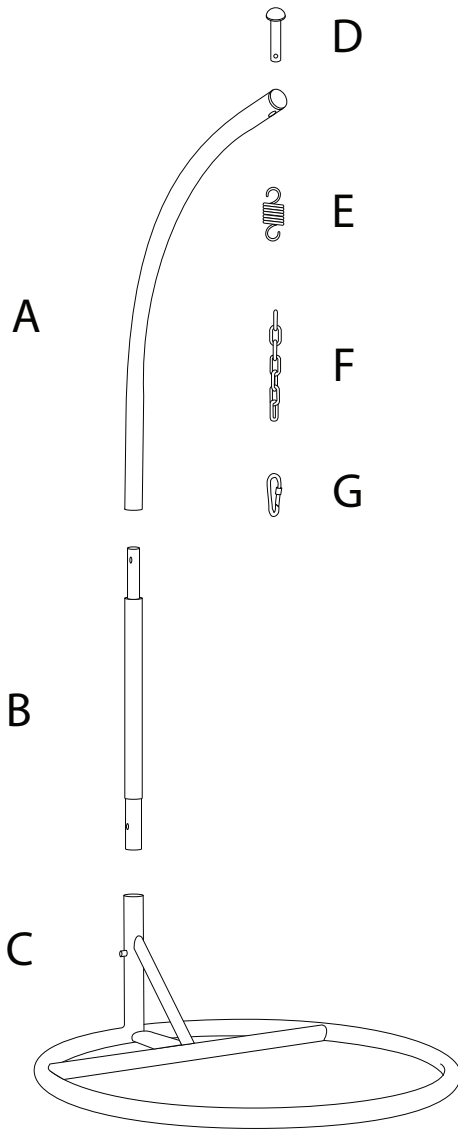
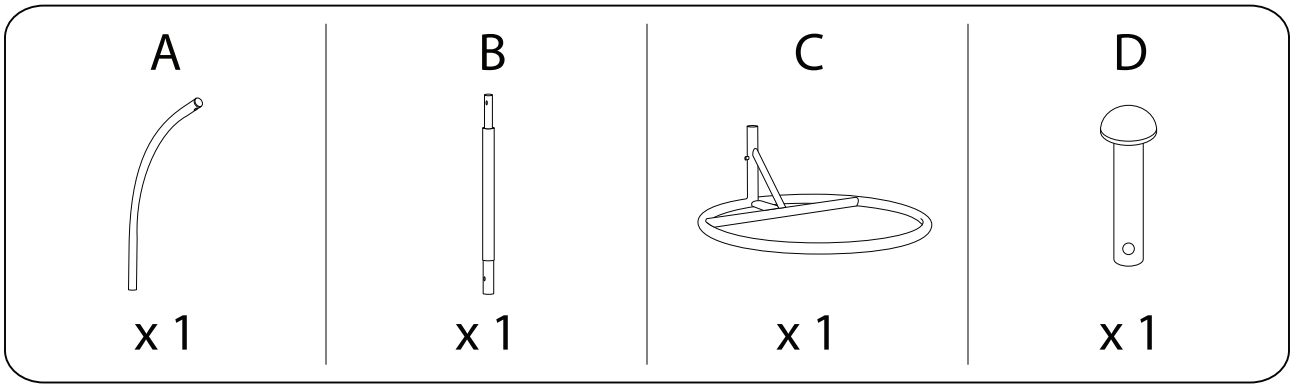

1

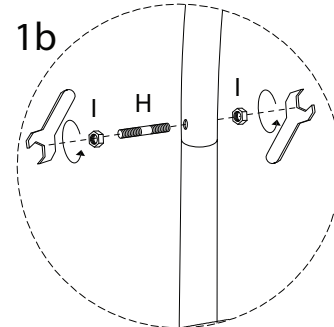
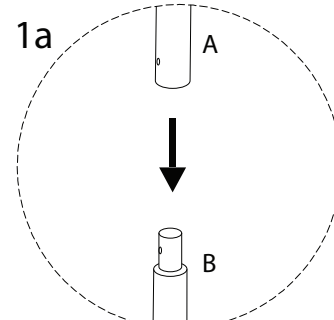
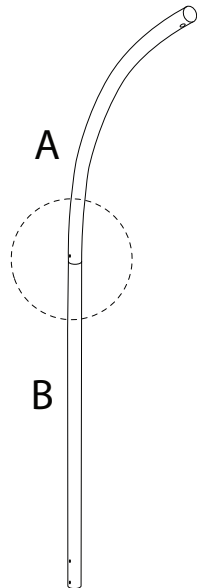
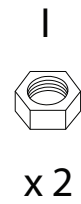
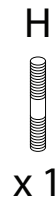
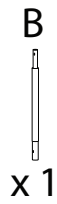

2

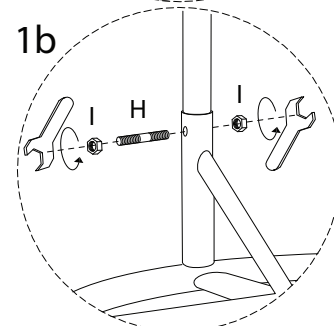
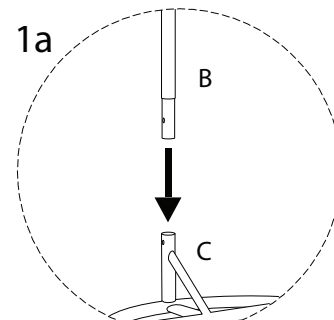
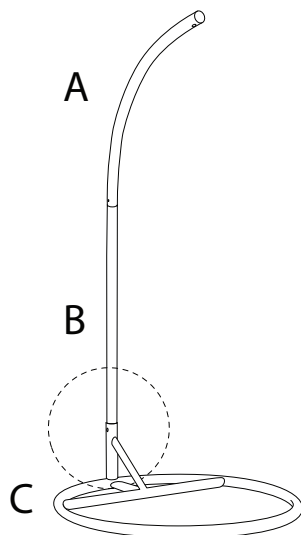
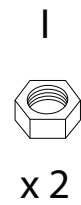
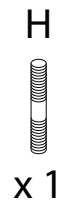
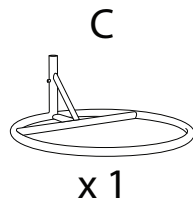

3

D

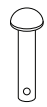

x 1

E



x 1

F

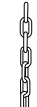

x 1

G



x 1

