

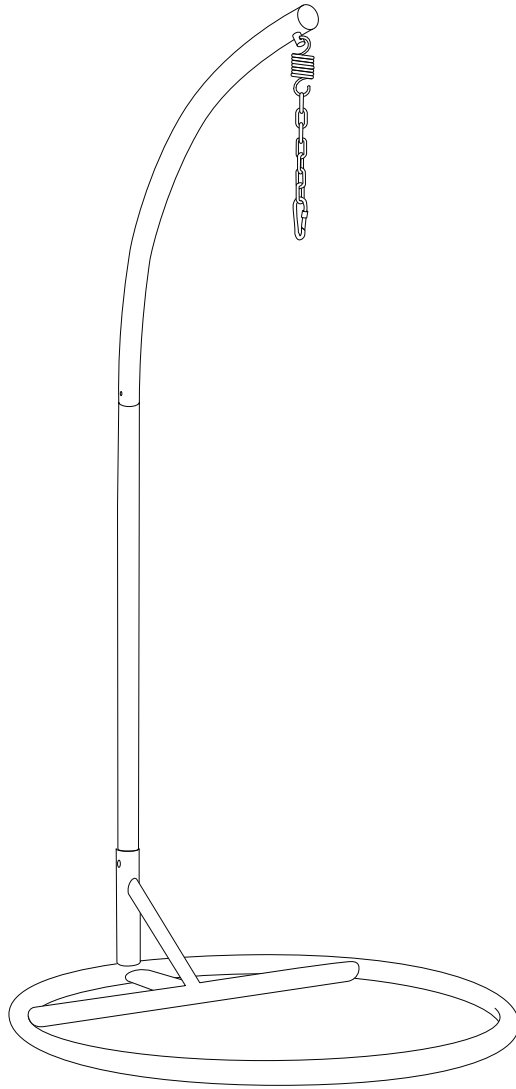

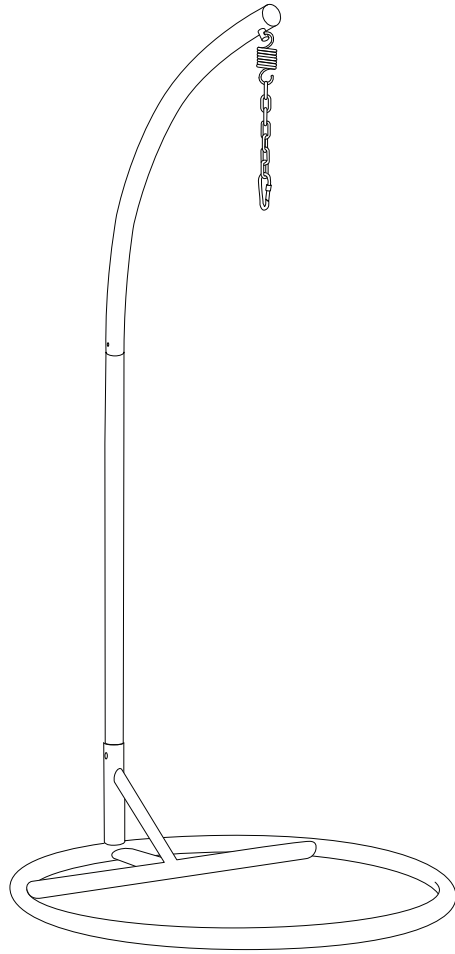

STAN

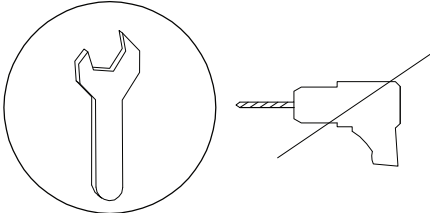

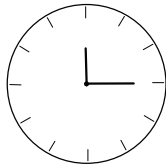
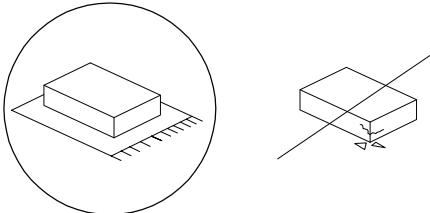

		
		15'
		
		1

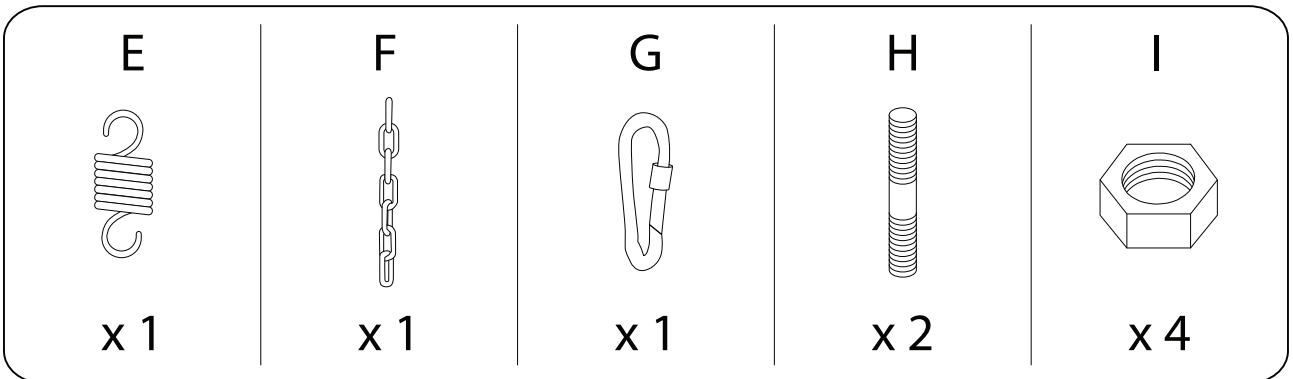
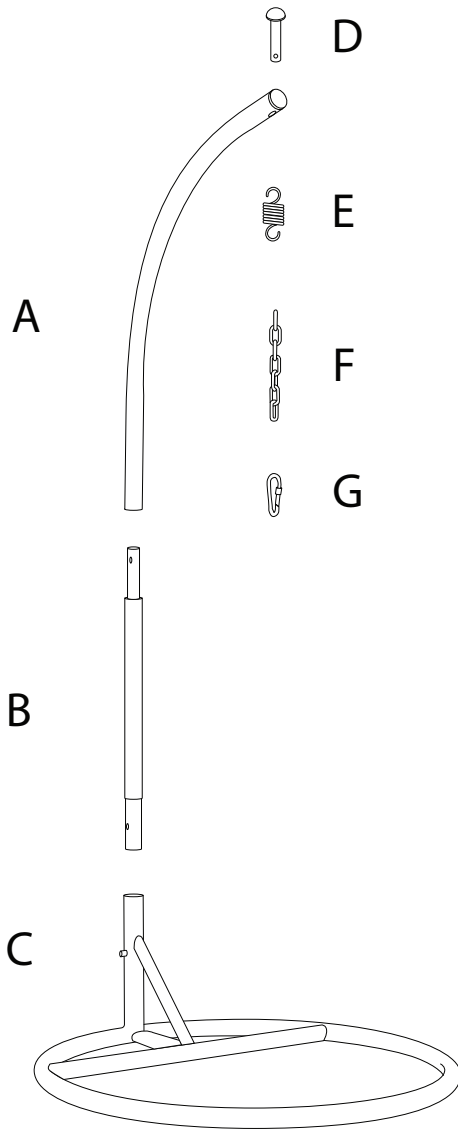
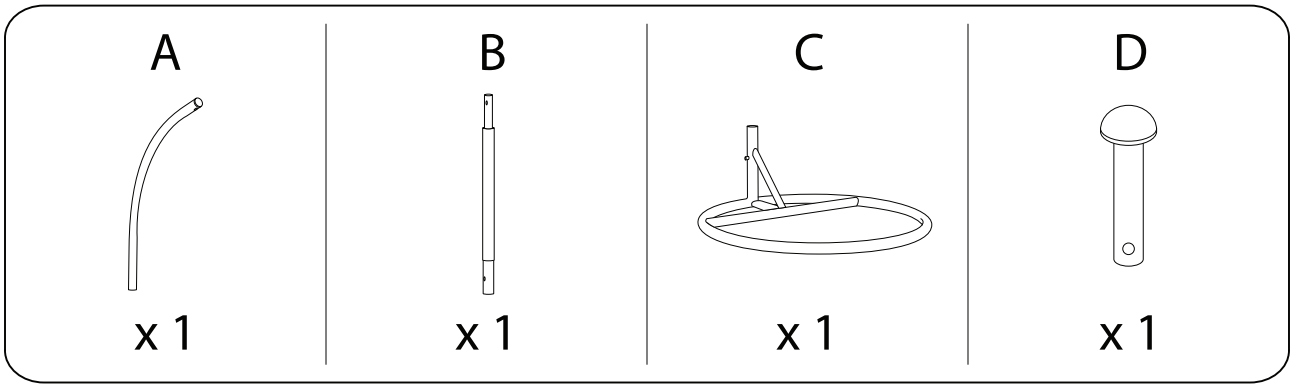

1

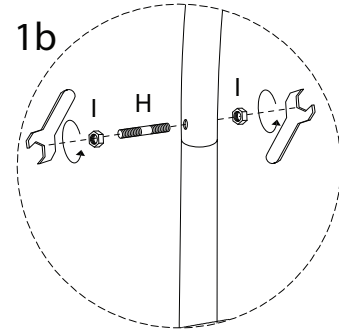
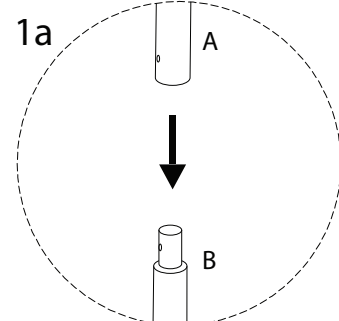
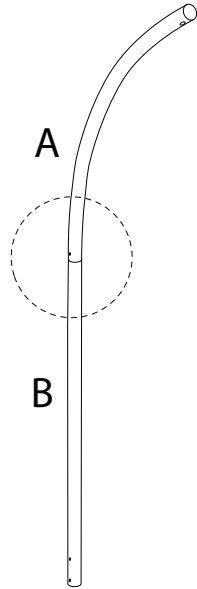
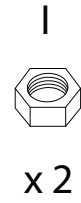
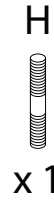

2

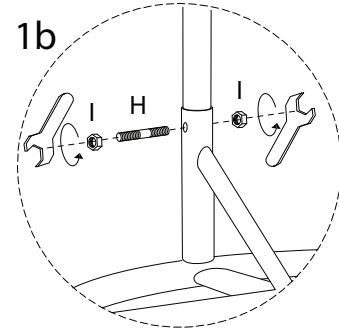
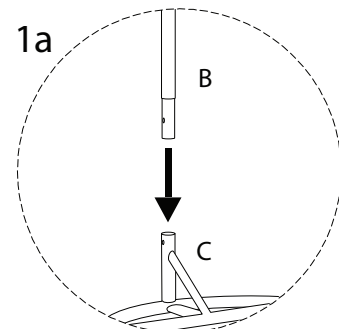
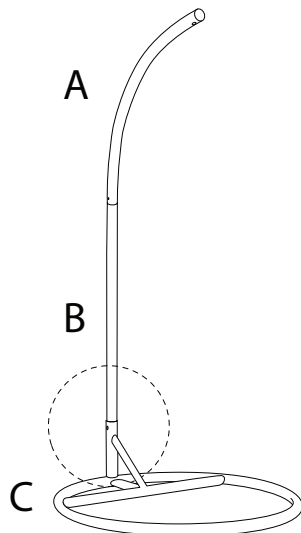
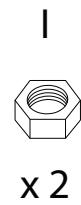
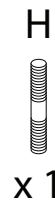
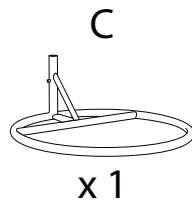

3

D



x 1

E



x 1

F

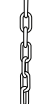

x 1

G



x 1

