

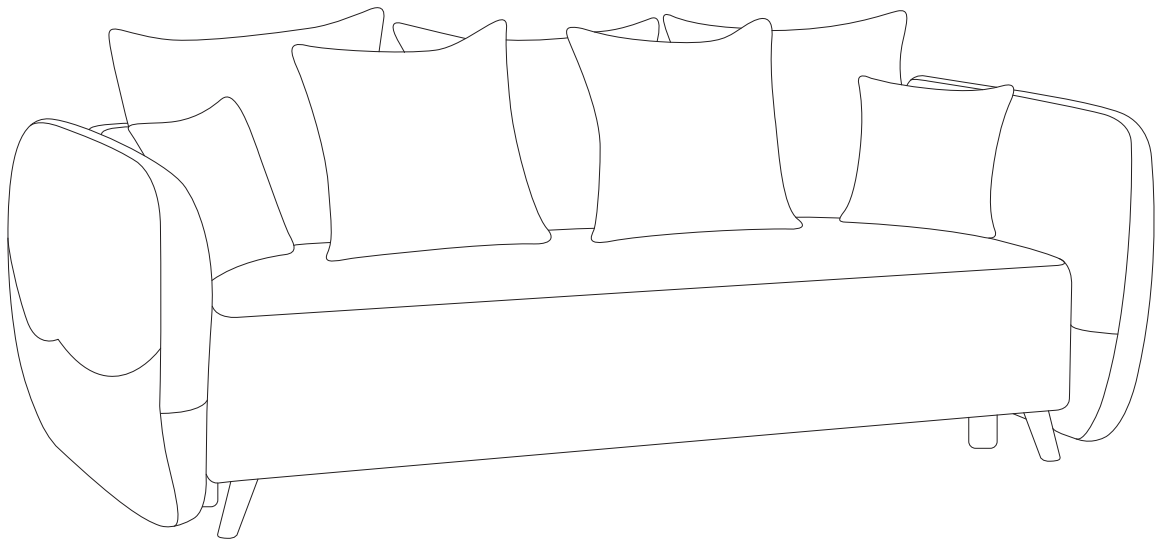

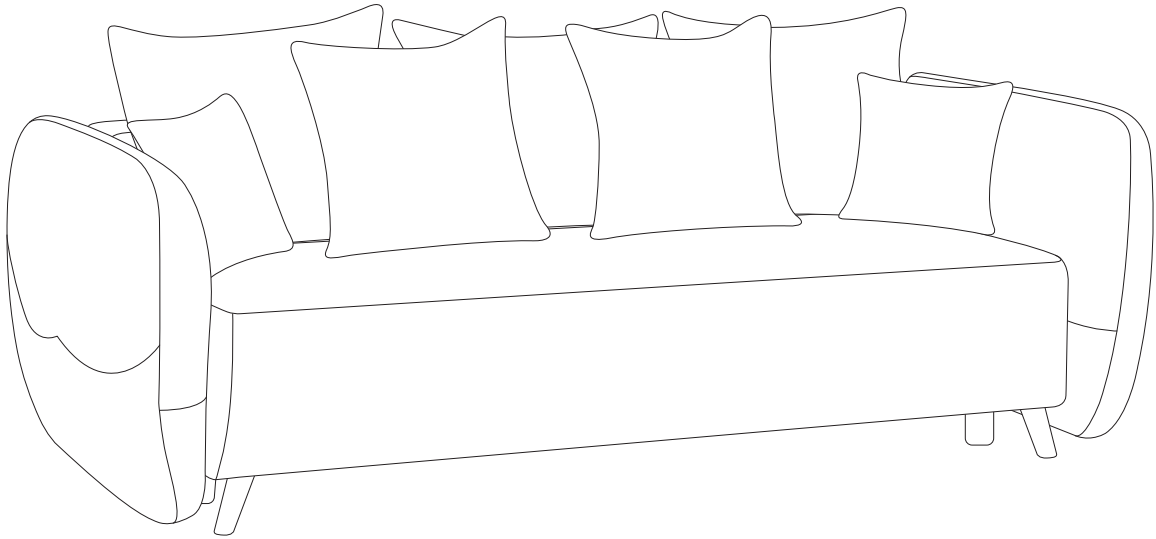

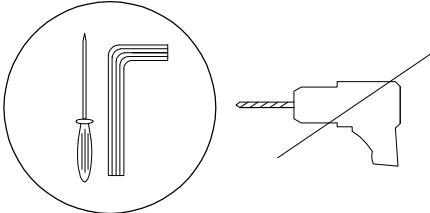



VALLANES

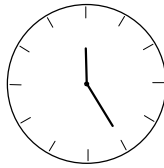
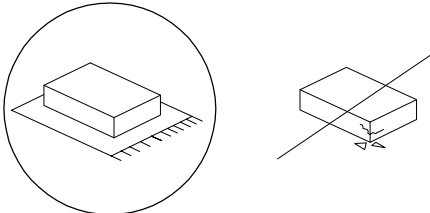

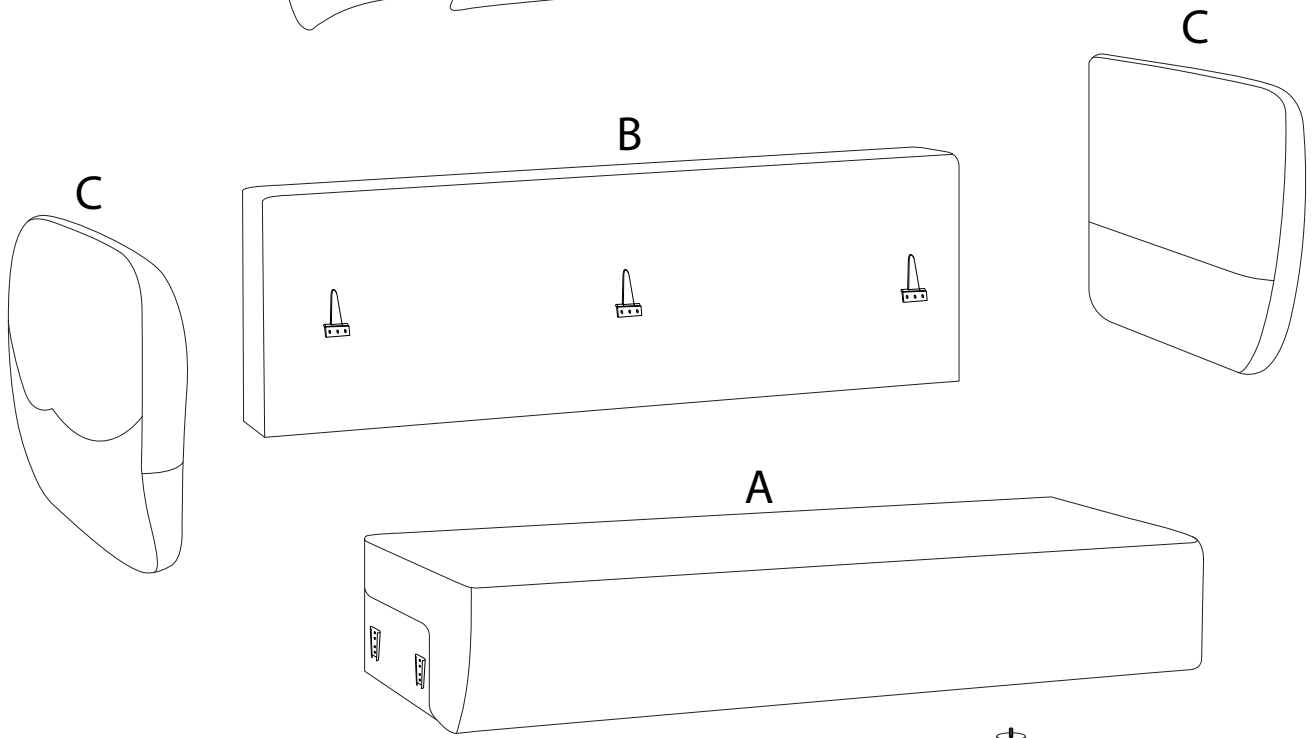
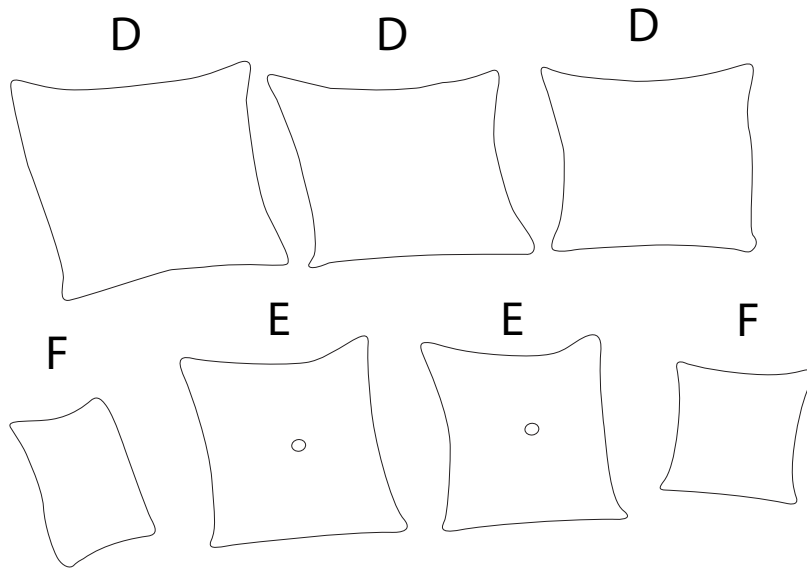

		
		25'
		
		2

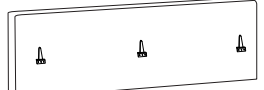

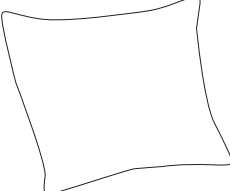
A	B	C	D
			
x 1	x 1	x 2	x 3

E

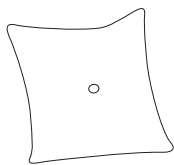

x 2

F

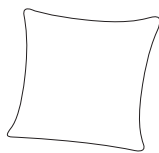

x 2

G



x 2

H

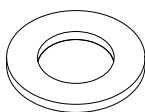

x 2

I

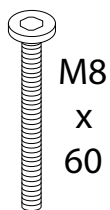

x 2

J

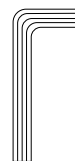

x 1

K

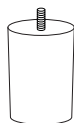

x 4

L

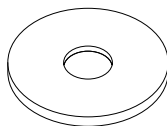

x 4

M



x 12

1

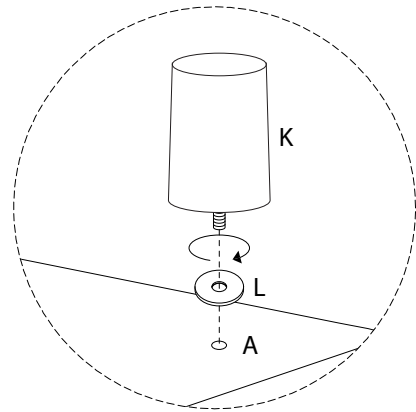
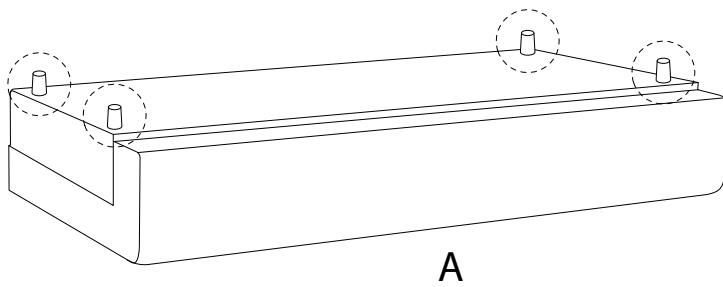
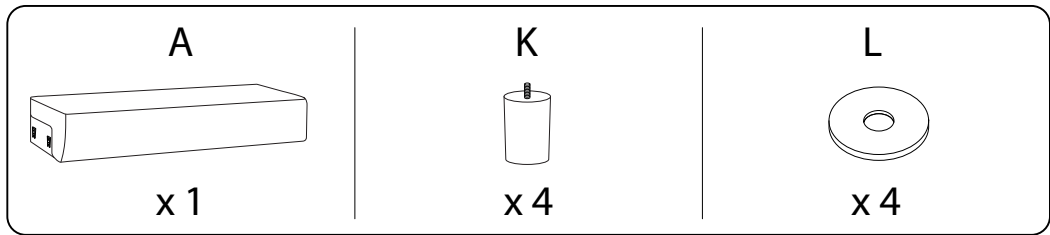

2

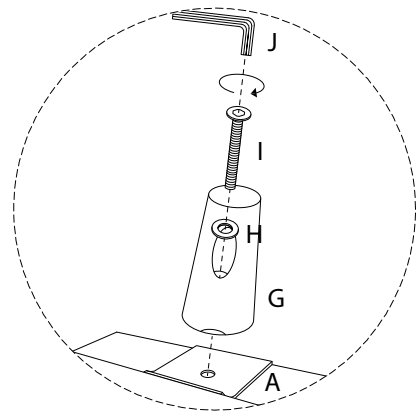
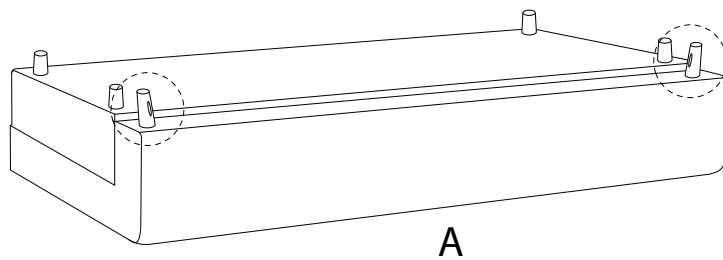
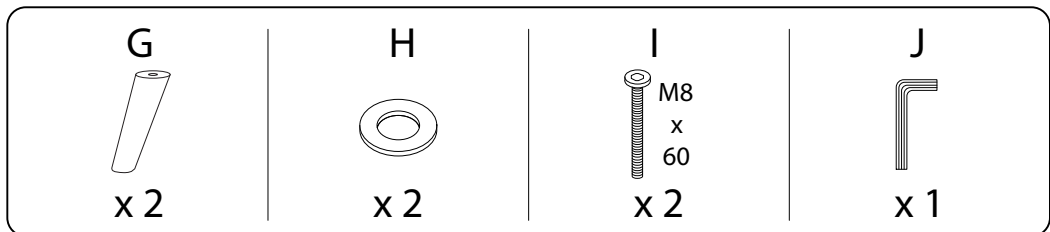

3

B

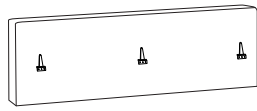

x 1

M



x 12

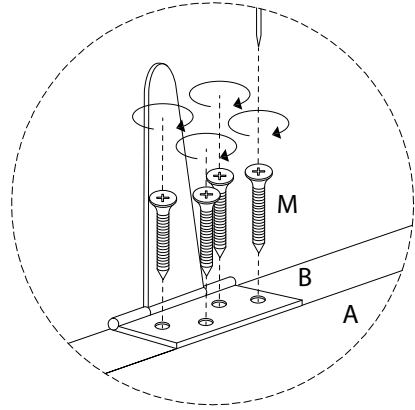
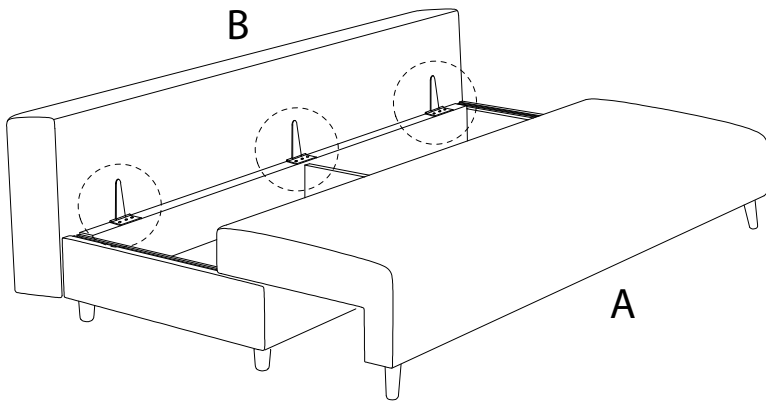

4

C



x 2

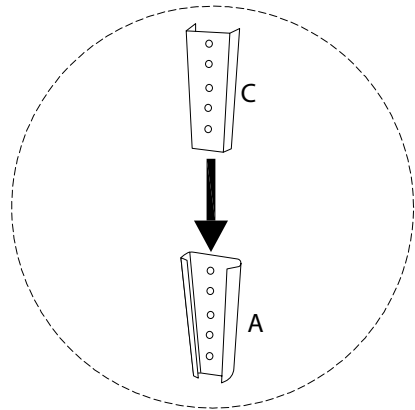
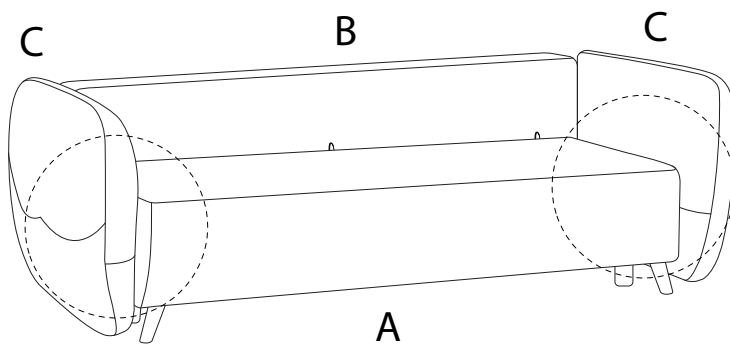

5

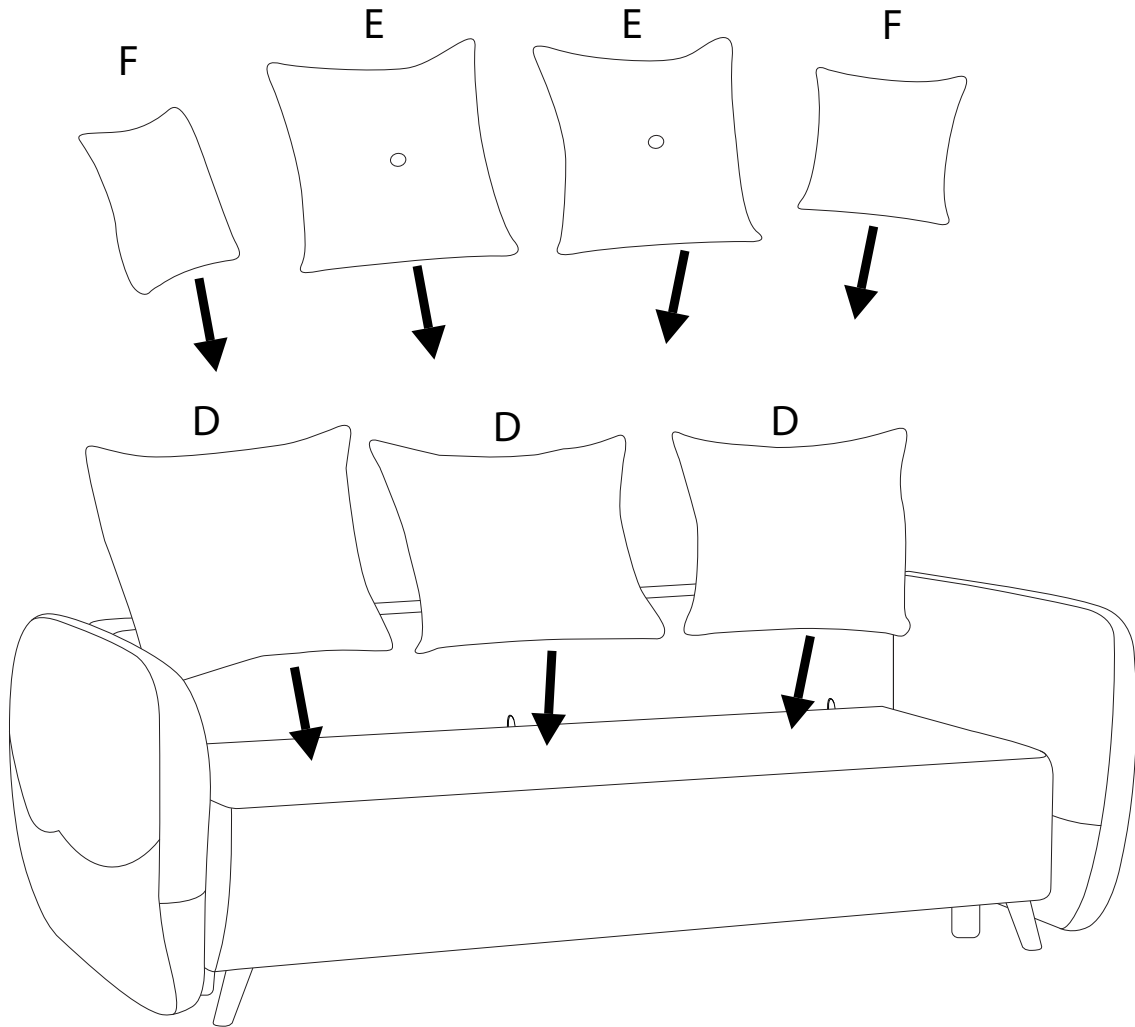
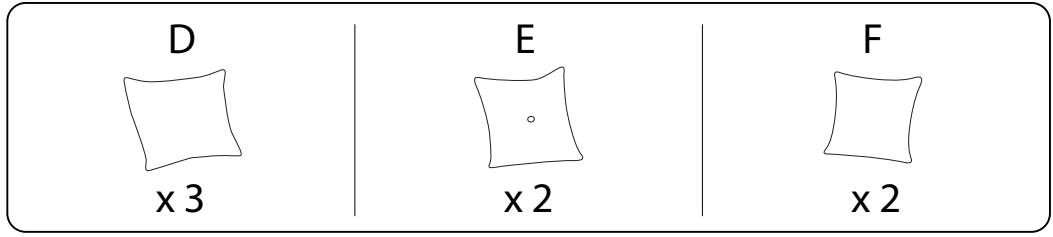

!

