

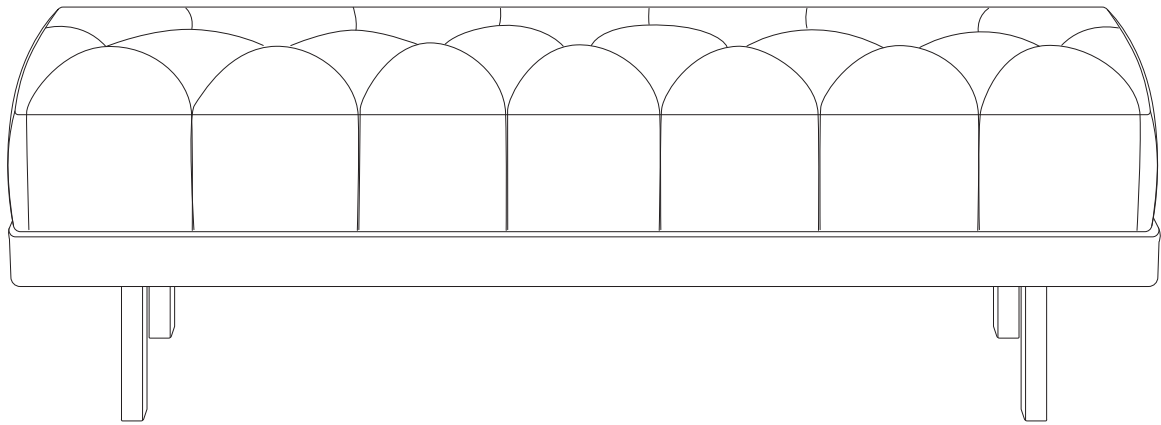

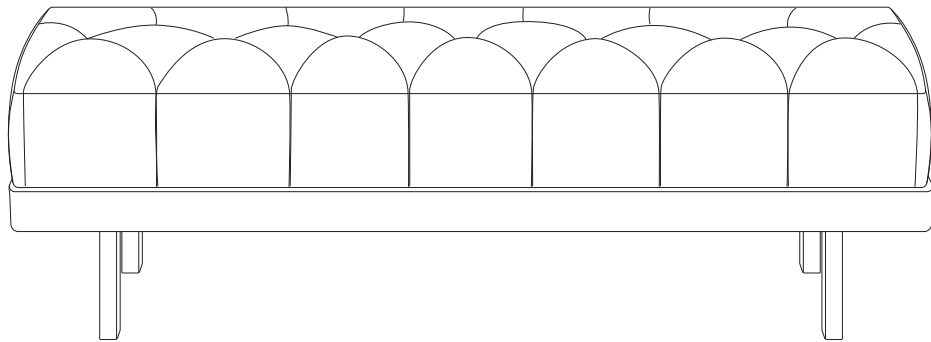

# ROSEVILLE

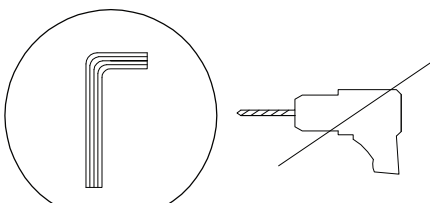

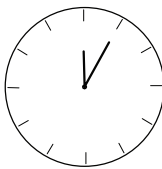
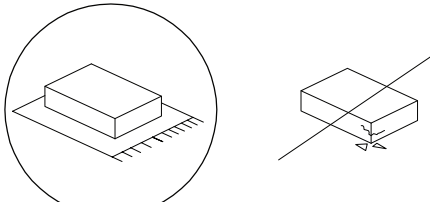

		
		
<p>5'</p>		<p>1</p>

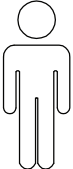
A

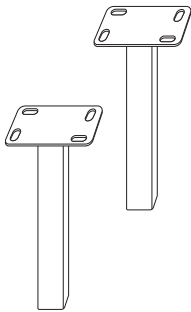
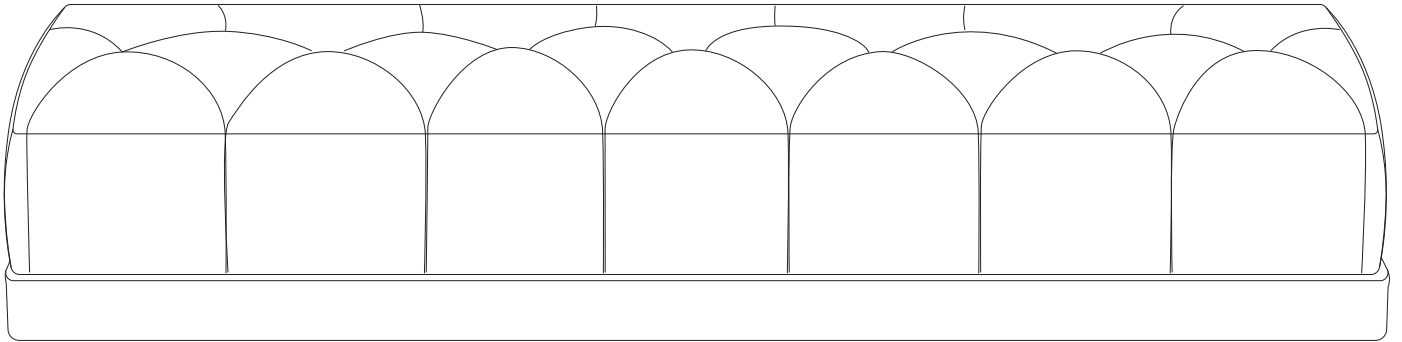

B x 4

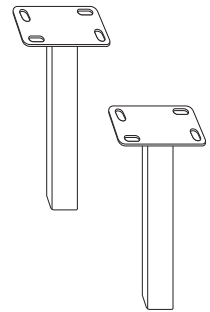

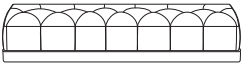
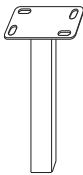
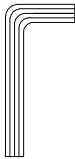
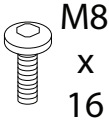
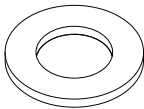

A	B	C	D	E
			 M8 x 16	
x 1	x 4	x 1	x 16	x 16

!

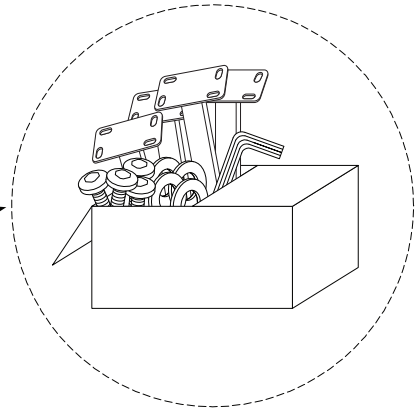
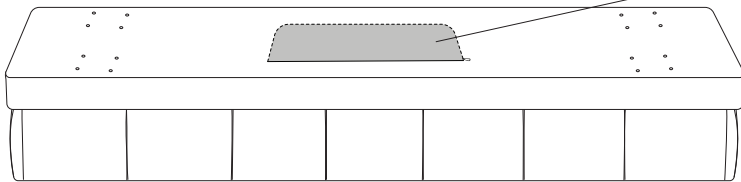
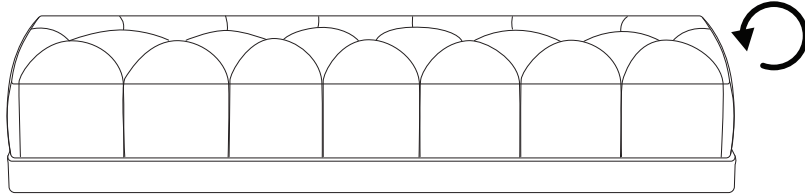
A

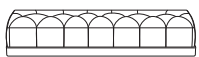
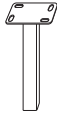
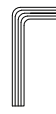

1

<p>A</p>  <p>x 1</p>	<p>B</p>  <p>x 4</p>	<p>C</p>  <p>x 1</p>	<p>D</p> <p>M8 x 16</p>  <p>x 16</p>	<p>E</p>  <p>x 16</p>
---	---	---	---	--

