

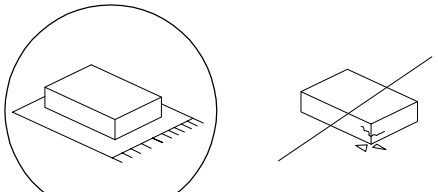

		45'
		
		2



F

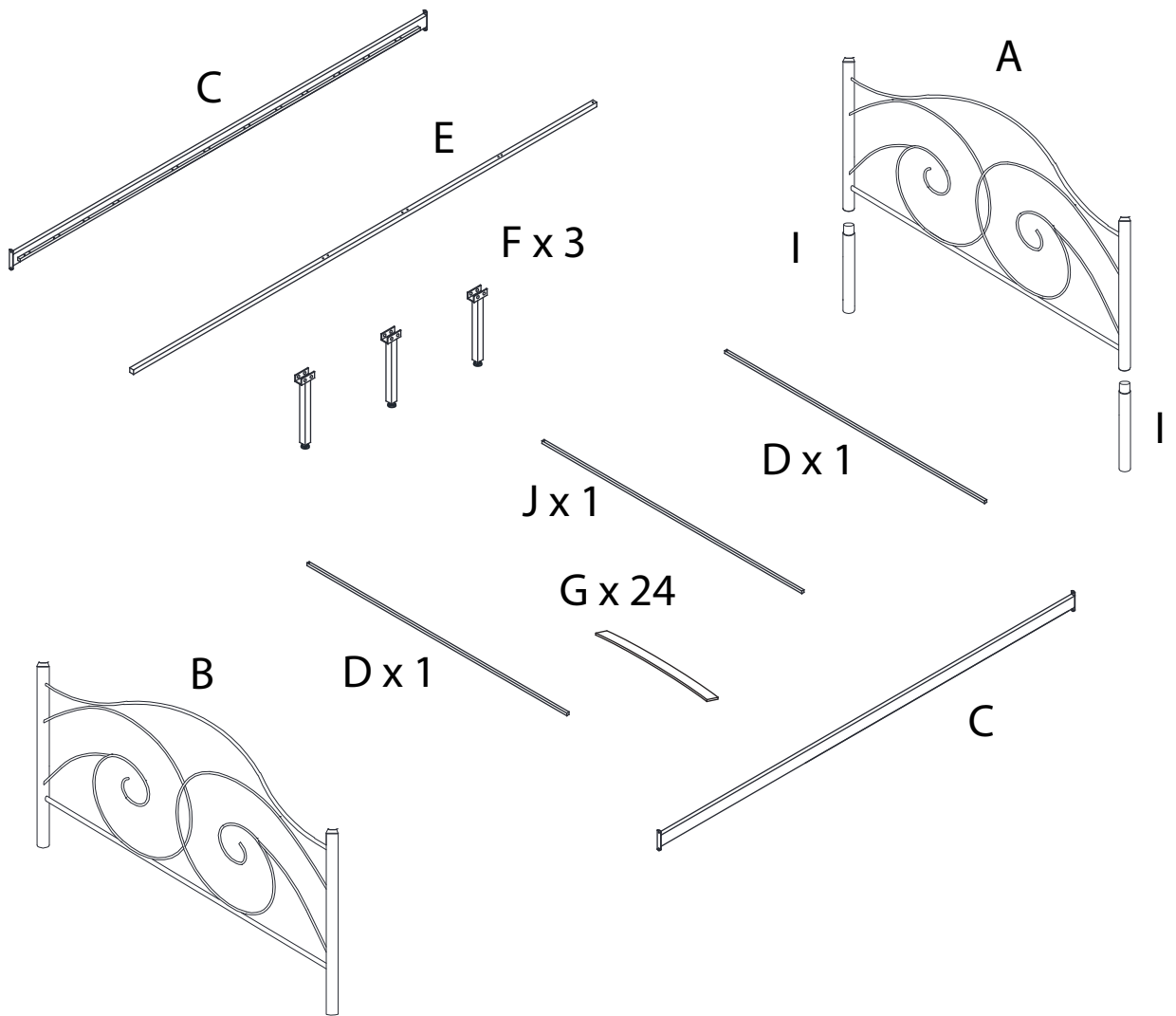
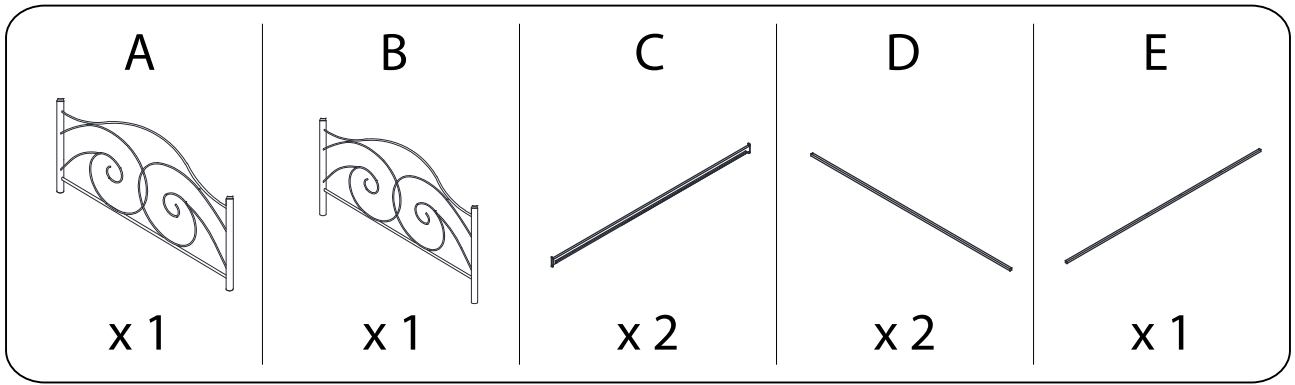

x 3

G

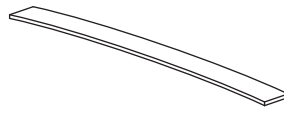

x 24

H



x 4

I



x 2

J

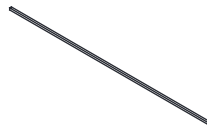

x 1

K

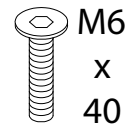

M6
x
40

x 9

L

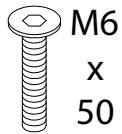

M6
x
50

x 6

M



M6
x
20

x 16

O

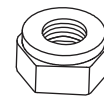

x 12

P

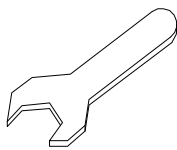

x 1

Q

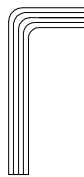

x 1

R

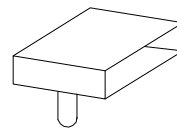

x 24

S

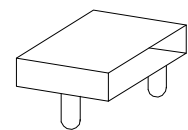

x 12

T

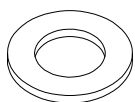

x 27

U



x 8

V



x 4

W



x 2

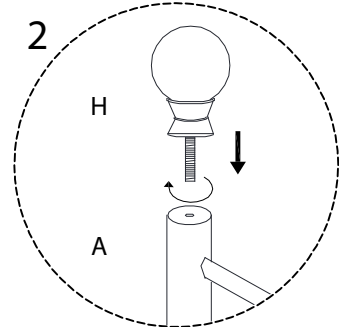
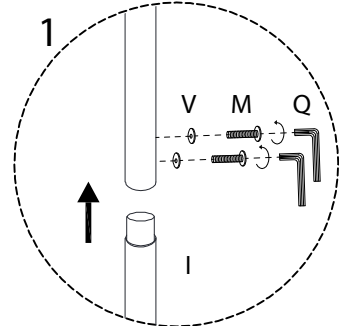
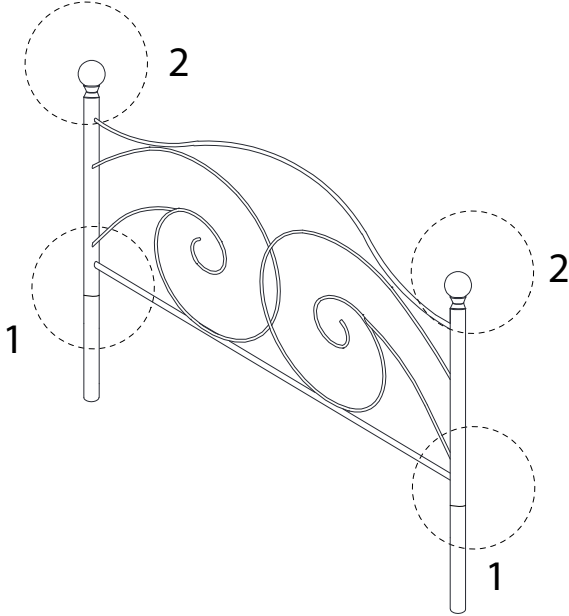
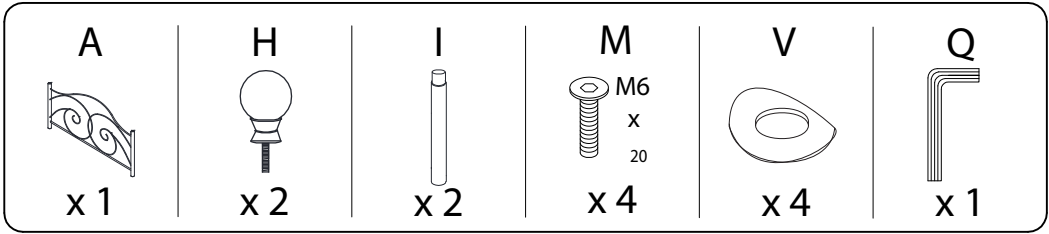

1

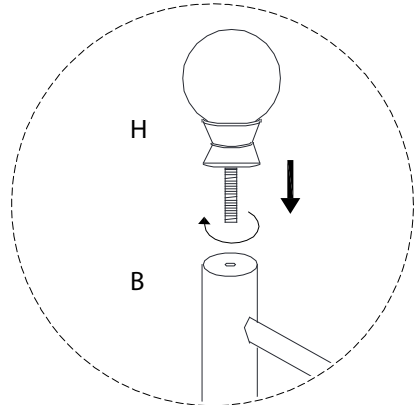
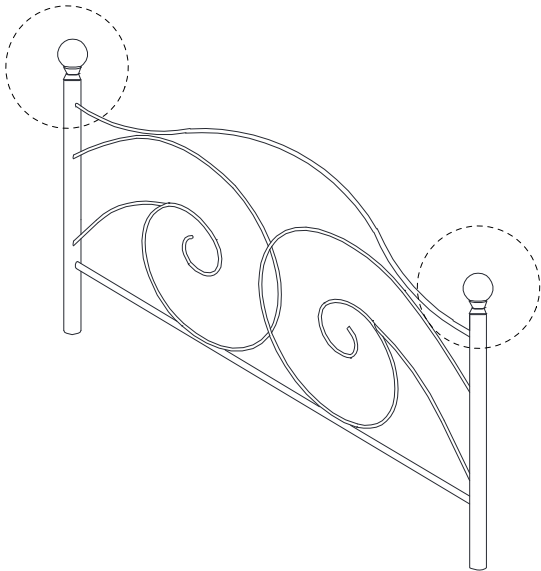
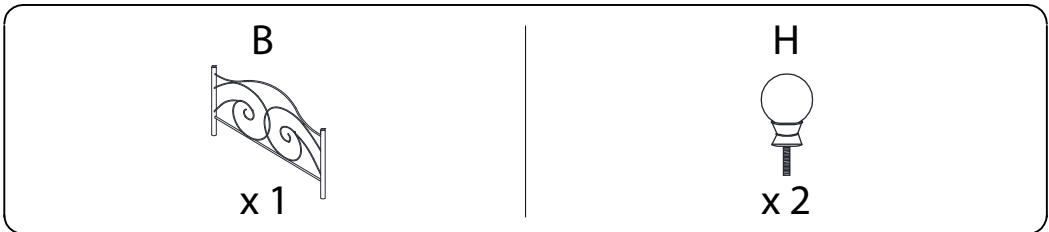

2



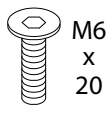

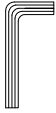
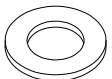
3

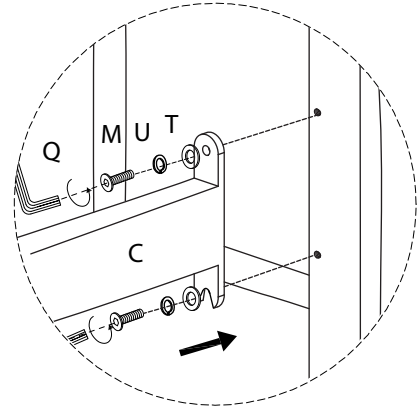
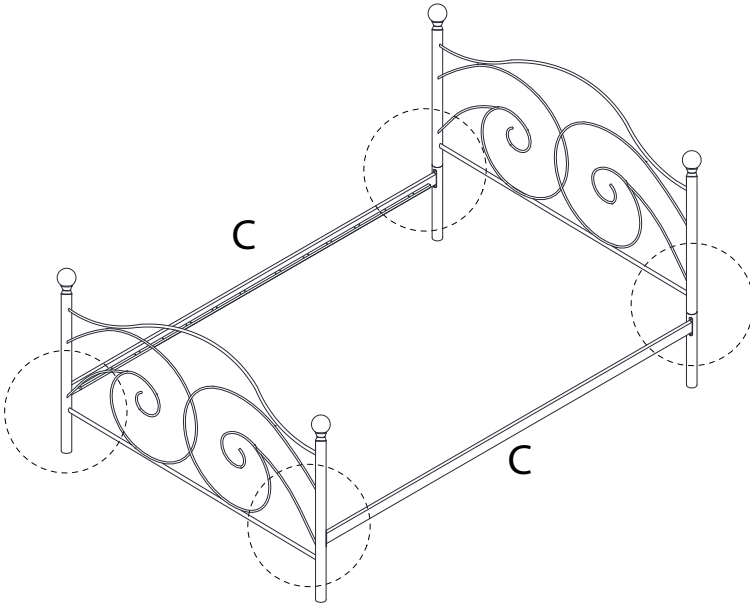
<p>C</p>  <p>x 2</p>	<p>M</p>  <p>M6 x 20 x 8</p>	<p>U</p>  <p>x 8</p>	<p>Q</p>  <p>x 1</p>	<p>T</p>  <p>x 8</p>
---	---	---	---	---





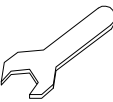
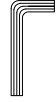
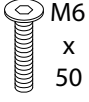

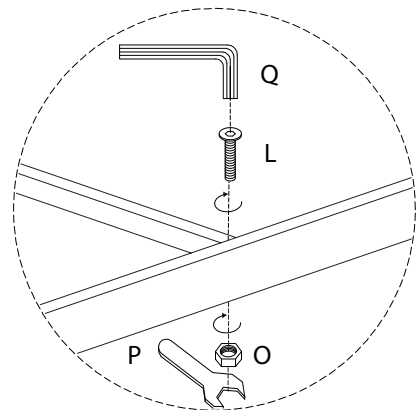
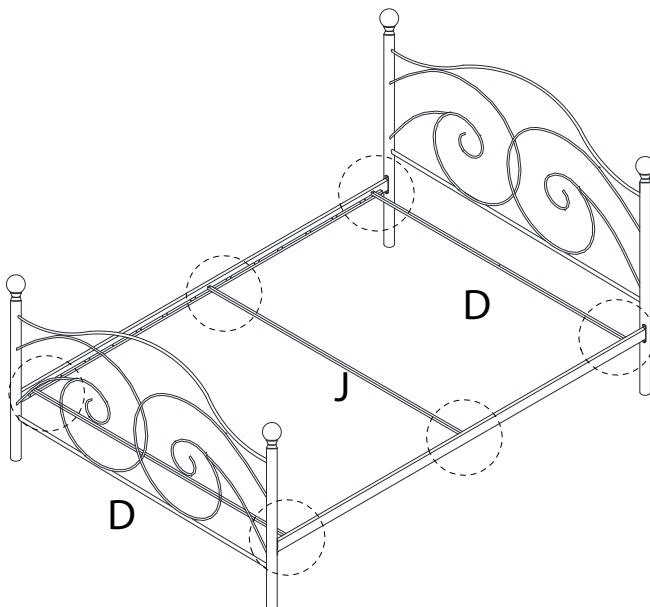
4

<p>D</p>  <p>x 2</p>	<p>J</p>  <p>x 1</p>	<p>O</p>  <p>x 6</p>	<p>P</p>  <p>x 1</p>	<p>Q</p>  <p>x 1</p>	<p>L</p>  <p>M6 x 50 x 6</p>
---	---	---	--	---	---



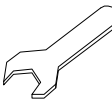
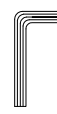

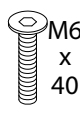

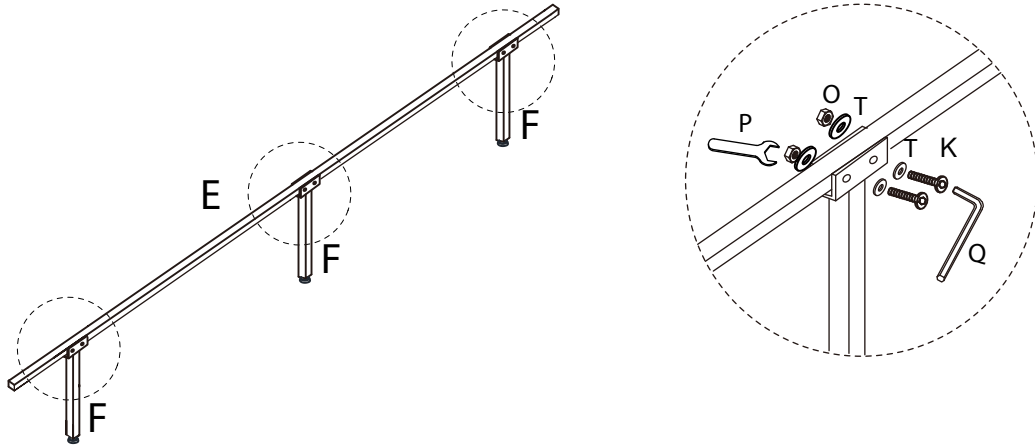
5

E	F	O	P	Q	T	K
						
x1	x3	x6	x1	x1	x12	M6 x 40 x6

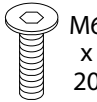

6

W	Q	T	M	K
				
x2	x1	x7	M6 x 20 x4	M6 x 40 x3

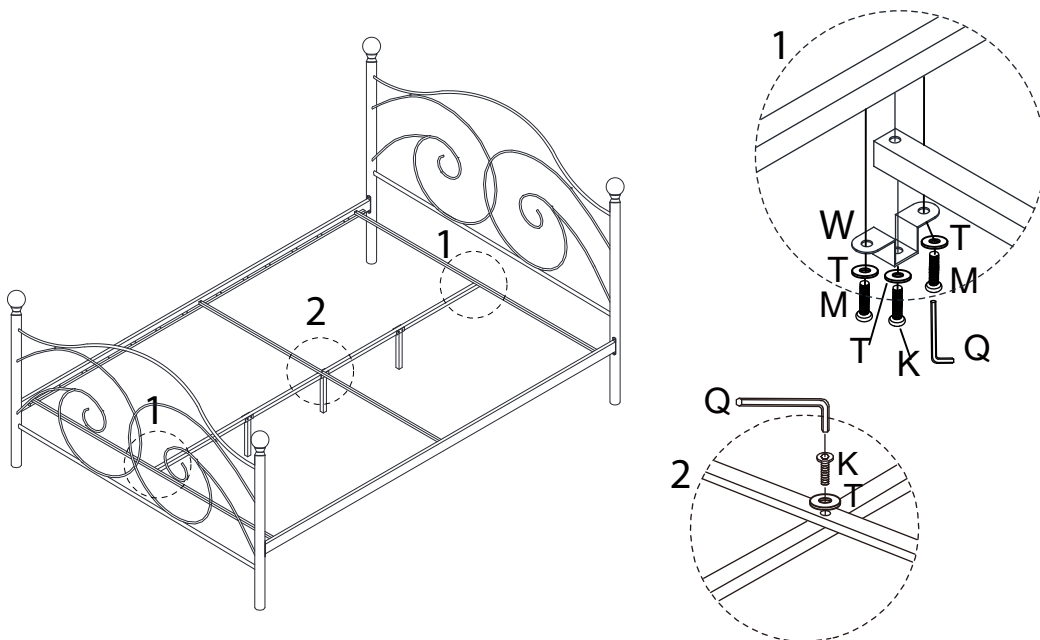

7

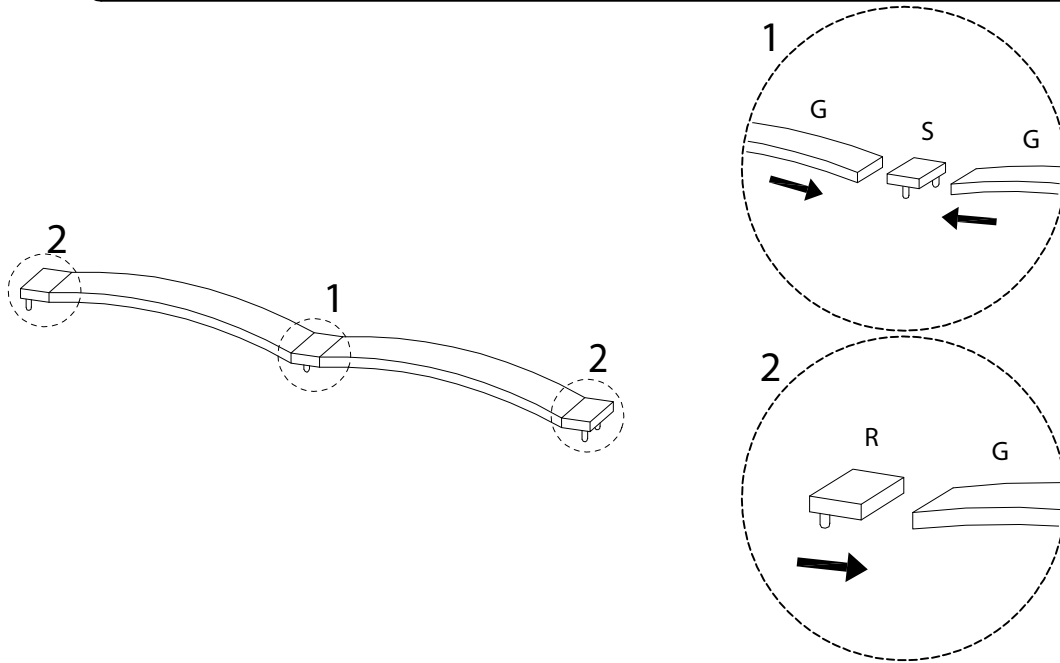
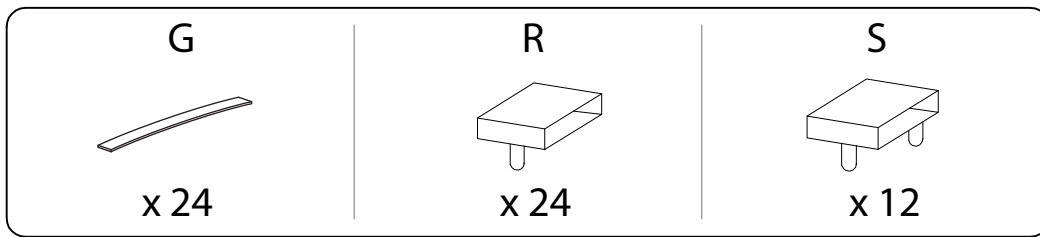

8 x 12

