

BOO

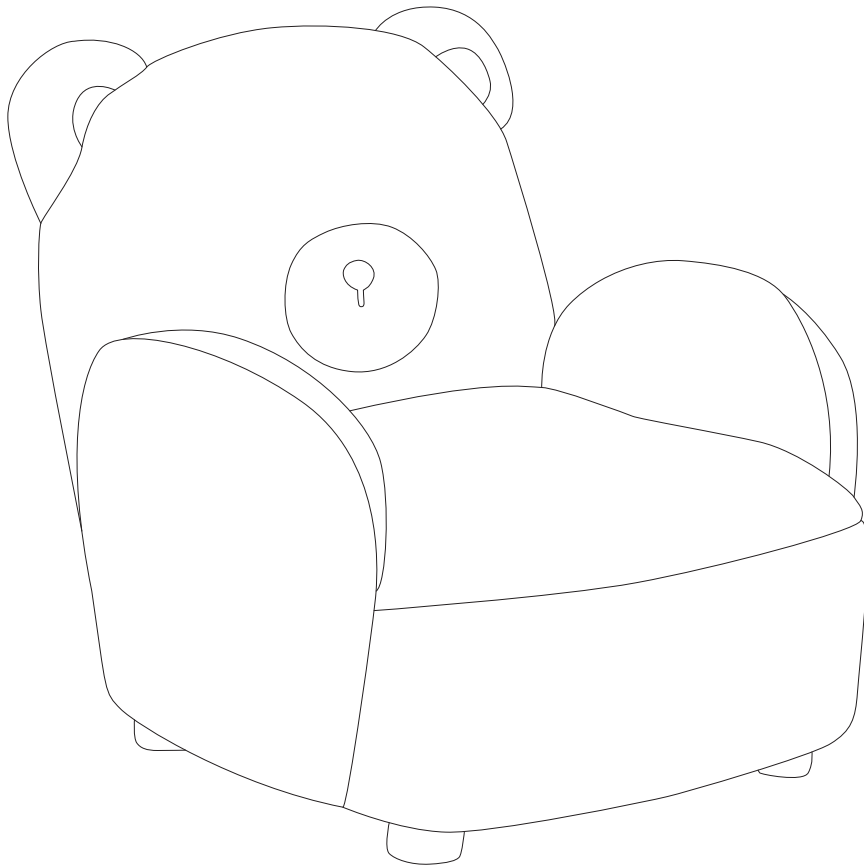

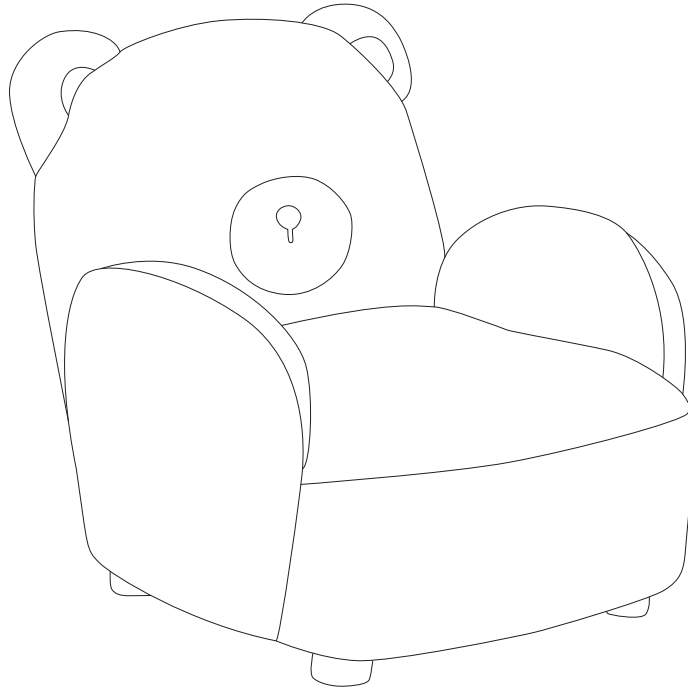
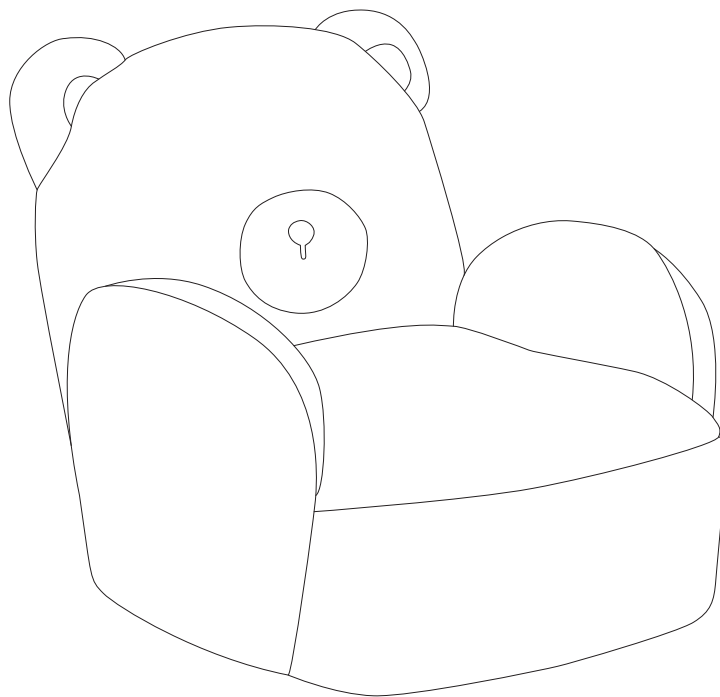

Diagram illustrating assembly instructions and safety warnings:





- Warning 1:** A crossed-out power drill icon indicates that a power drill should not be used for assembly.
- Warning 2:** A crossed-out icon of a block being drilled from the bottom indicates that drilling should not be performed on the underside of the chair.
- Time:** A clock icon with the number 5' indicates that the assembly process should take approximately 5 minutes.
- Personnel:** An icon of a person with the number 1 indicates that one person is required for assembly.

A

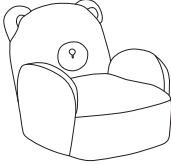

2 x 4



1	2	A	B
			
x 1	x 4	x 4	x 4

1

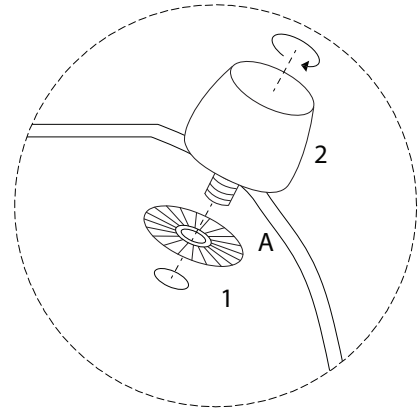
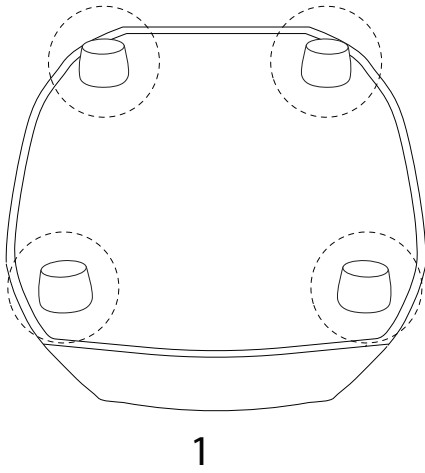
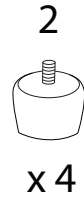

2

