

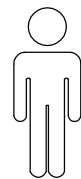

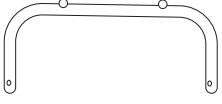









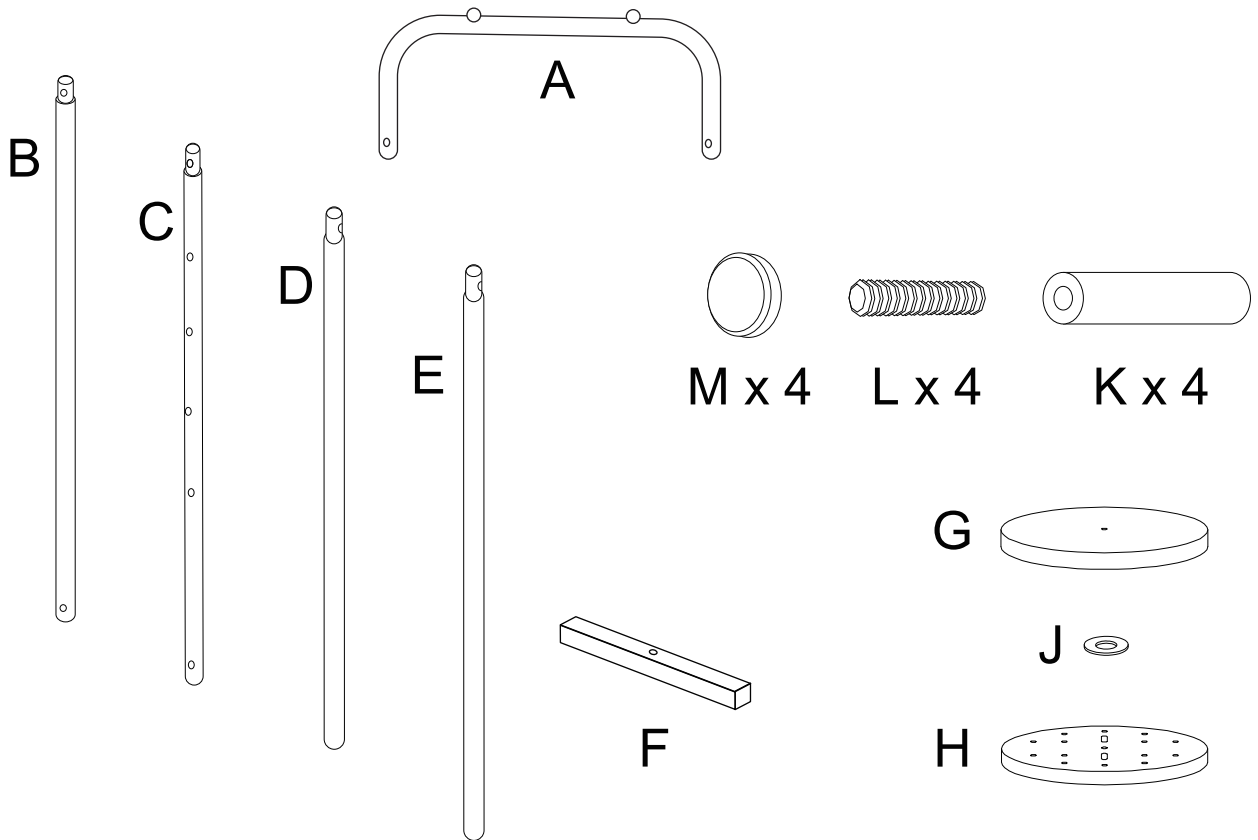

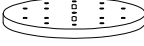

30'



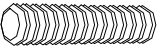







1

| | | | | |
|--|---|---|---|---|
| A  x1 | B  Ø22 x 820 x1 | C  Ø22 x 820 x1 | D  Ø22 x 815 x1 | E  Ø22 x 830 x1 |
|--|---|---|---|---|





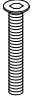

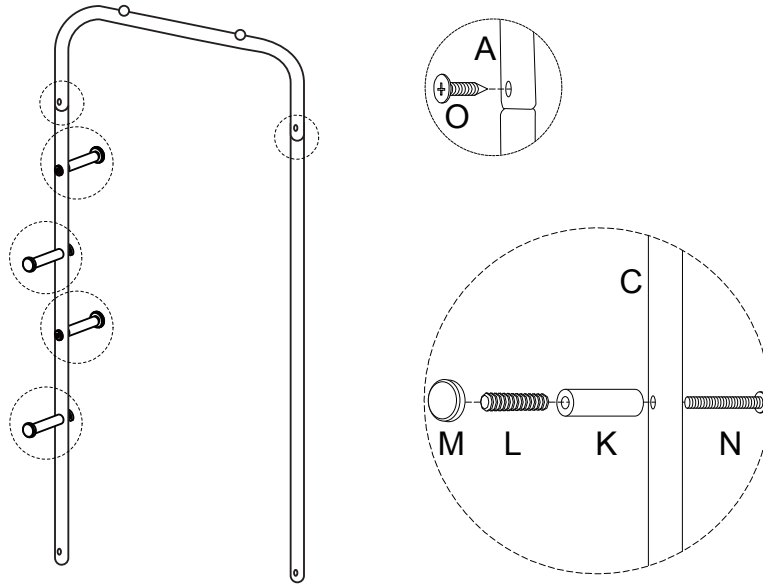

| | | | | | | |
|--|--|---|---|--|--|--|
| F  x1 | G  x1 | H  x1 | I  x2 | J  x1 | K  x4 | R  x1 |
| L  x4 | M  x4 | N  M6 x 35 x5 | O  M4 x 12 x4 | P  M6 x 45 x1 | Q  x1 | |

1

| | | | | | | | |
|---|--|--|---|--|---|--|--|
| A  x1 | B Ø22 x 820  x1 | C Ø22 x 820  x1 | K  x4 | L  x4 | M  x4 | N M6 x 35  x4 | O M4 x 12  x2 |
|---|--|--|---|--|---|--|--|

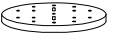

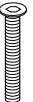
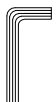

2

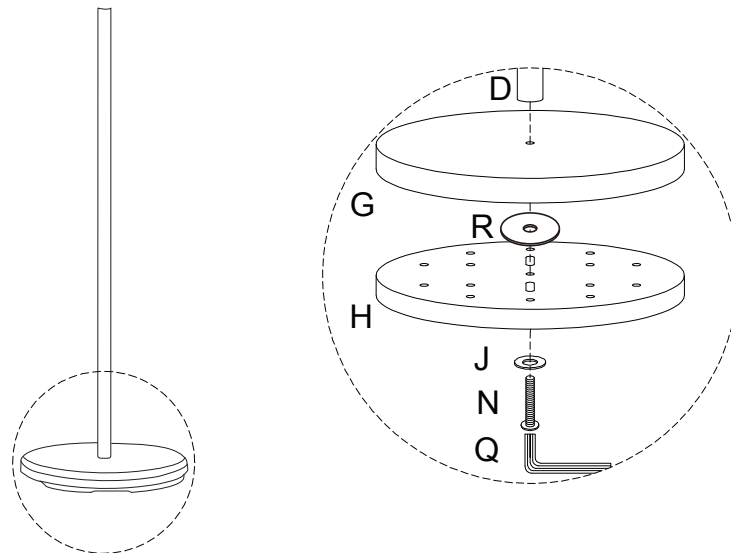
| | | | | | | |
|--|---|---|---|--|---|---|
| D Ø22 x 815  x1 | G  x1 | H  x1 | J  x1 | N M6 x 35  x1 | Q  x1 | R  x1 |
|--|---|---|---|--|---|---|

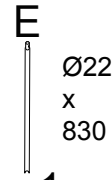
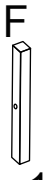

3

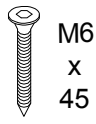
| | | | |
|---|--|---|---|
| <p>E</p>  <p>Ø22 x 830</p> <p>x 1</p> | <p>F</p>  <p>x 1</p> | <p>I</p>  <p>x 2</p> | <p>P</p>  <p>M6 x 45</p> <p>x 1</p> |
|---|--|---|---|

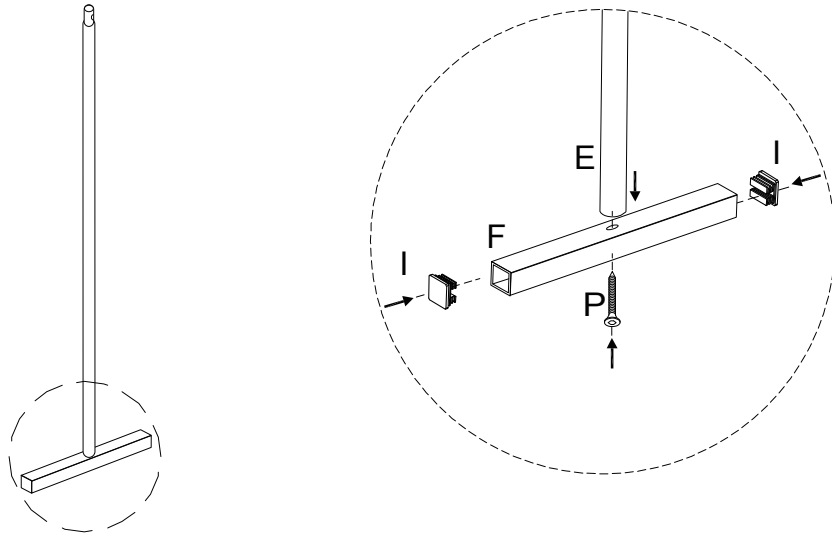

4

| |
|---|
| <p>O</p>  <p>M4 x 12</p> <p>x 2</p> |
|---|

