

KRISTINES

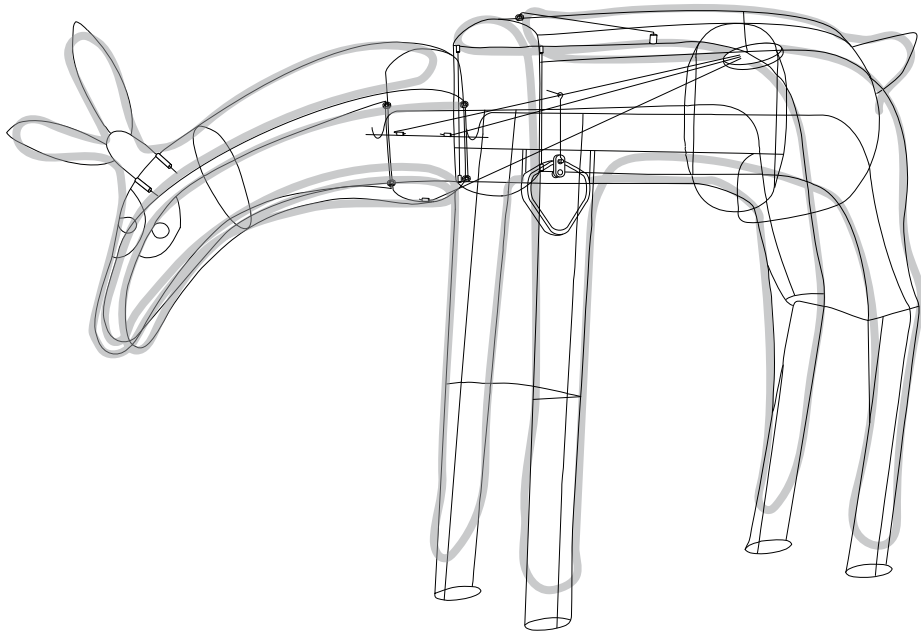

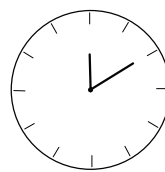

10'

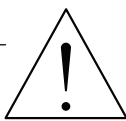
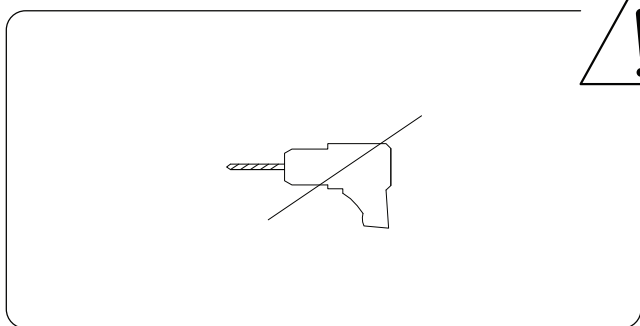
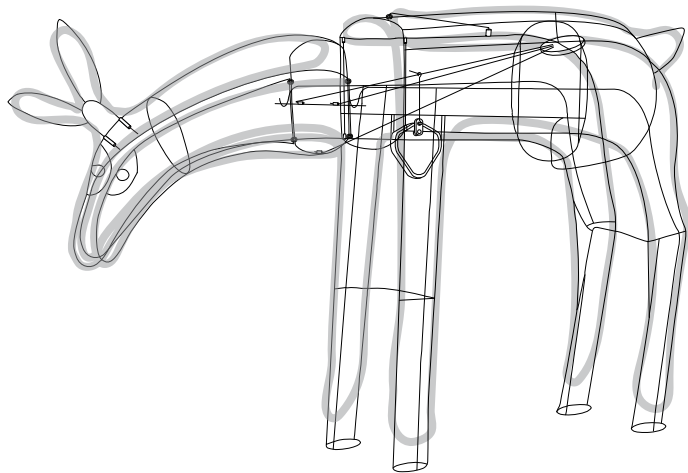
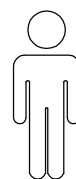
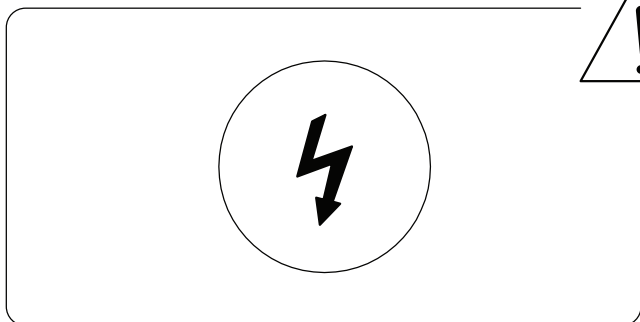

2

B

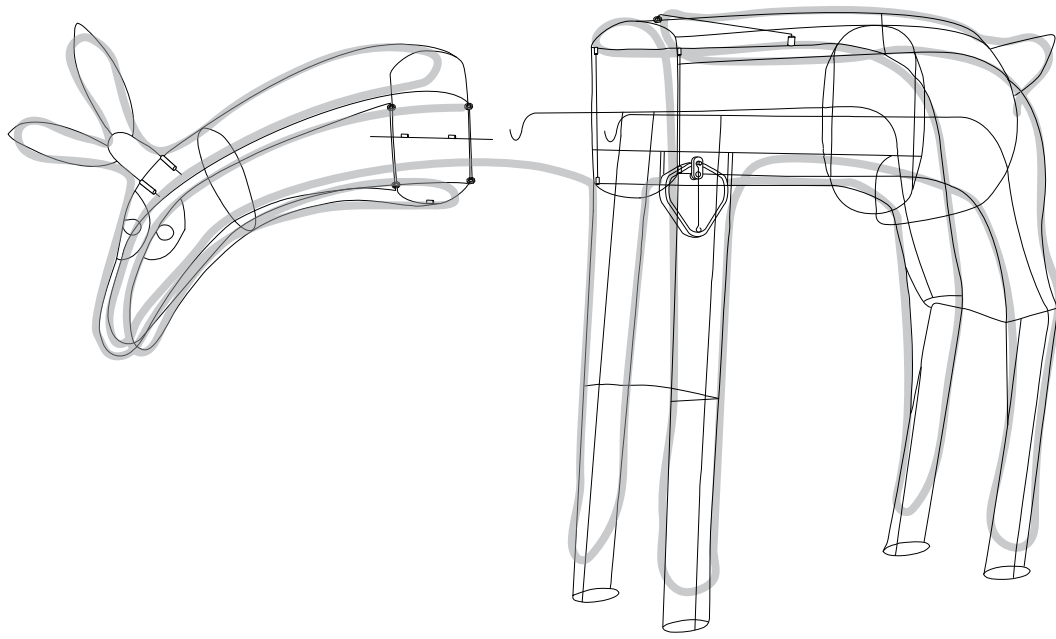
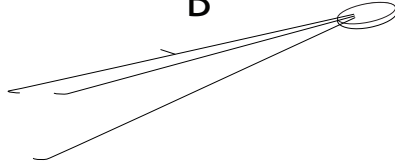

A

A

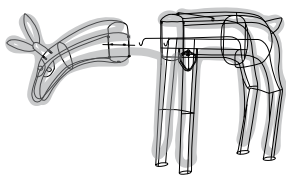

x 1

B

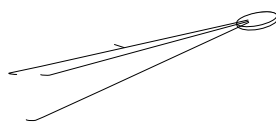

x 1

C

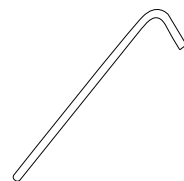

x 4

1

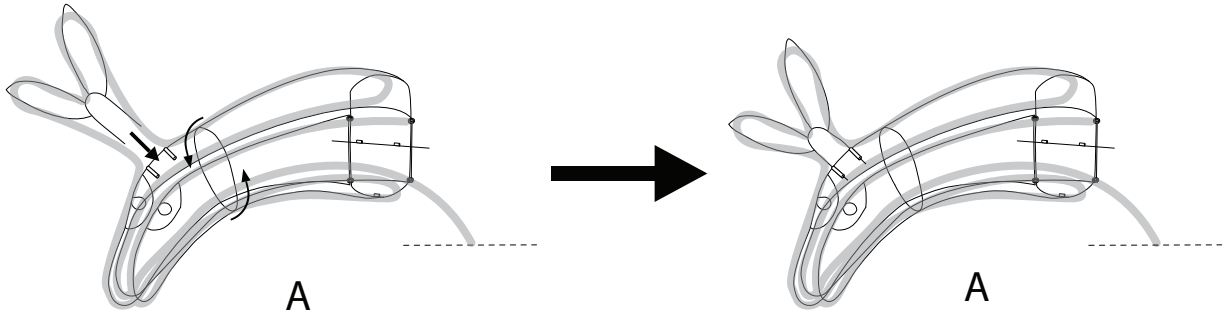
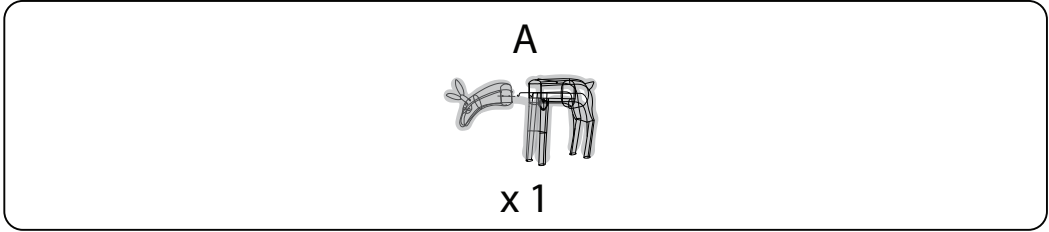

2

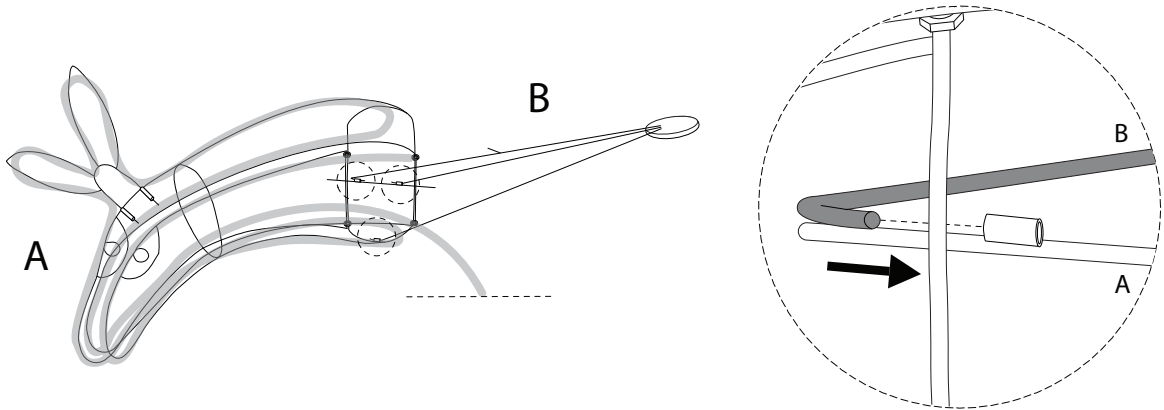
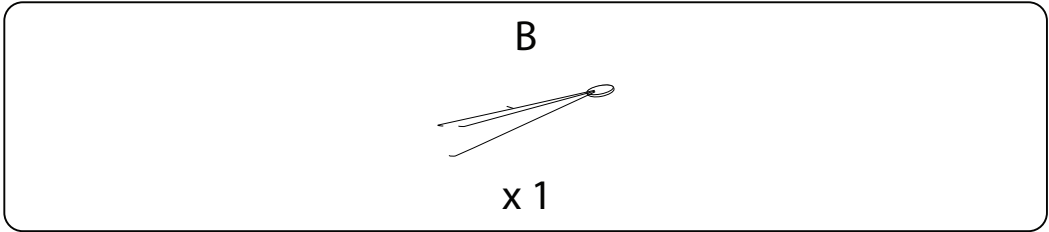

3

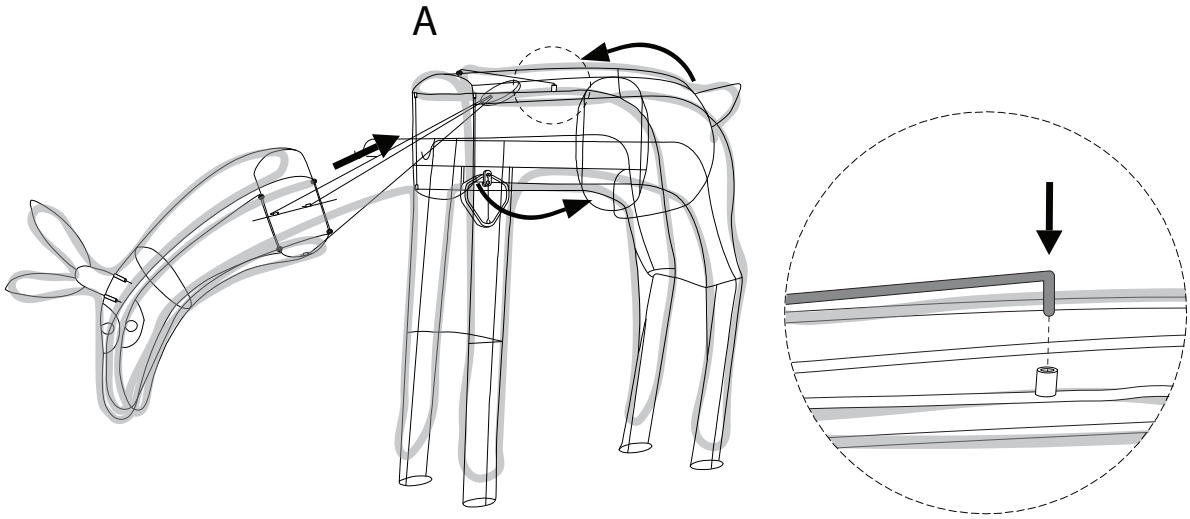

4

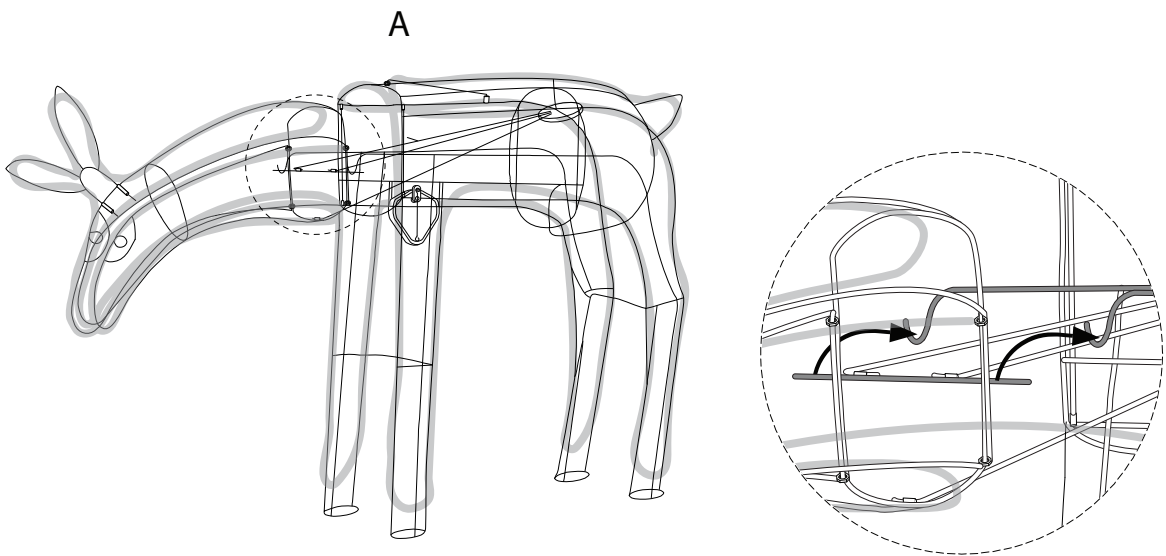

5

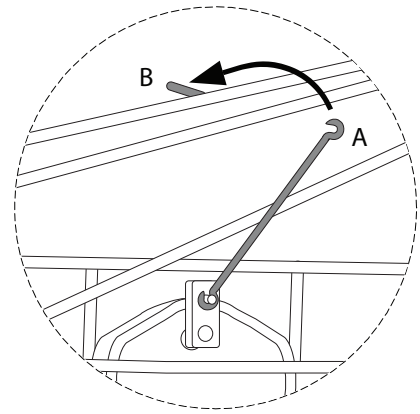
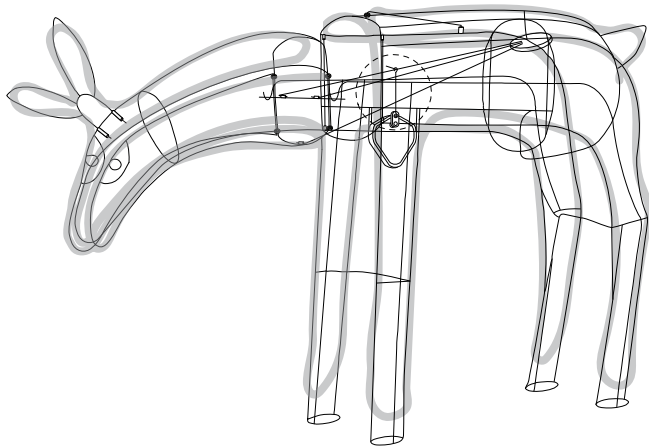

6

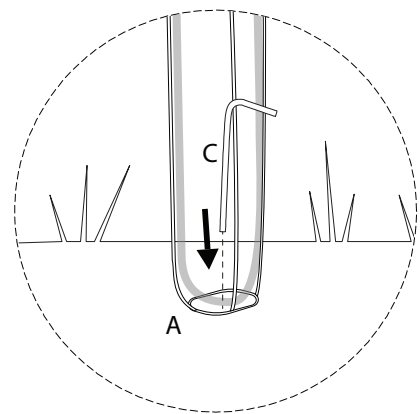
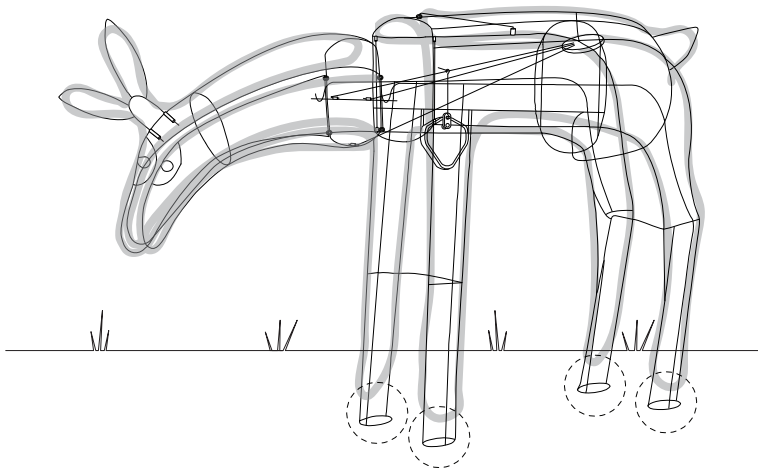

7

