

		<b>15'</b>
		
		<b>1</b>

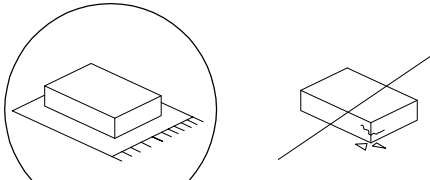

**A x 2**

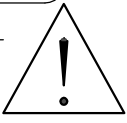
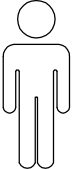
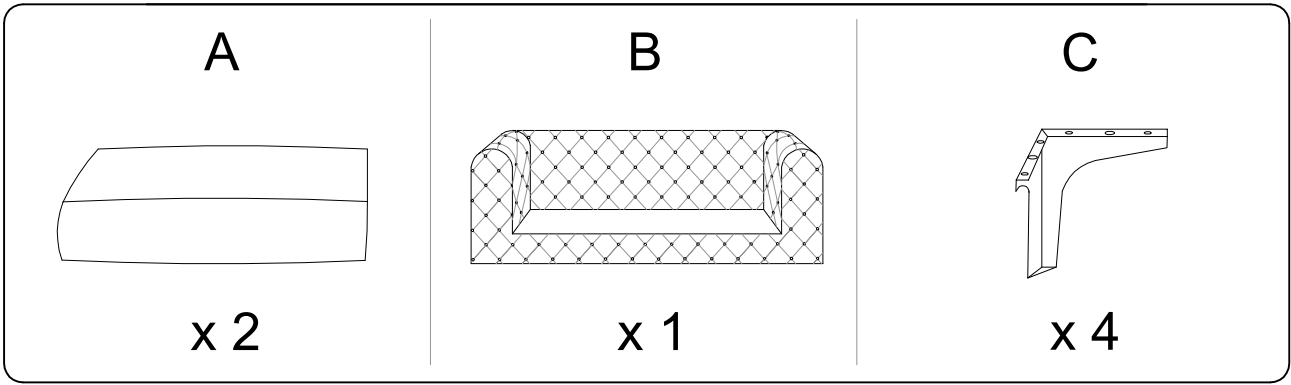
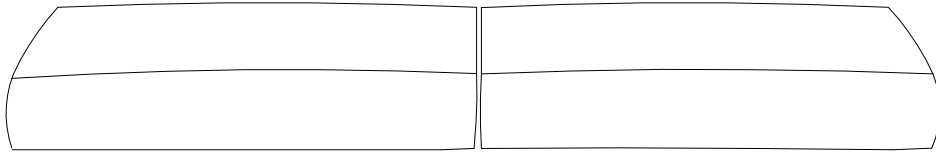
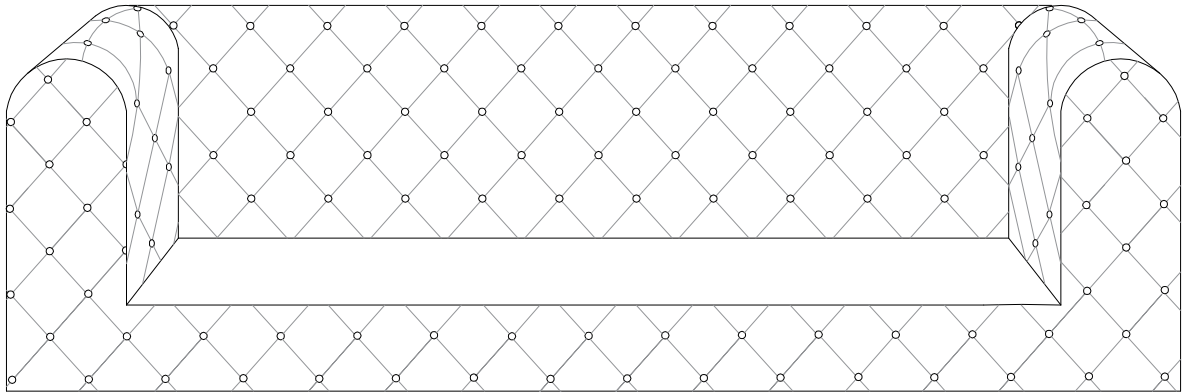

**B**



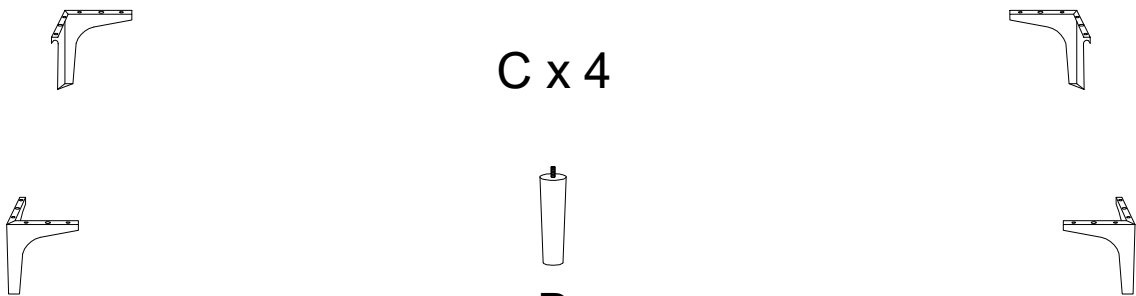

**C x 4**

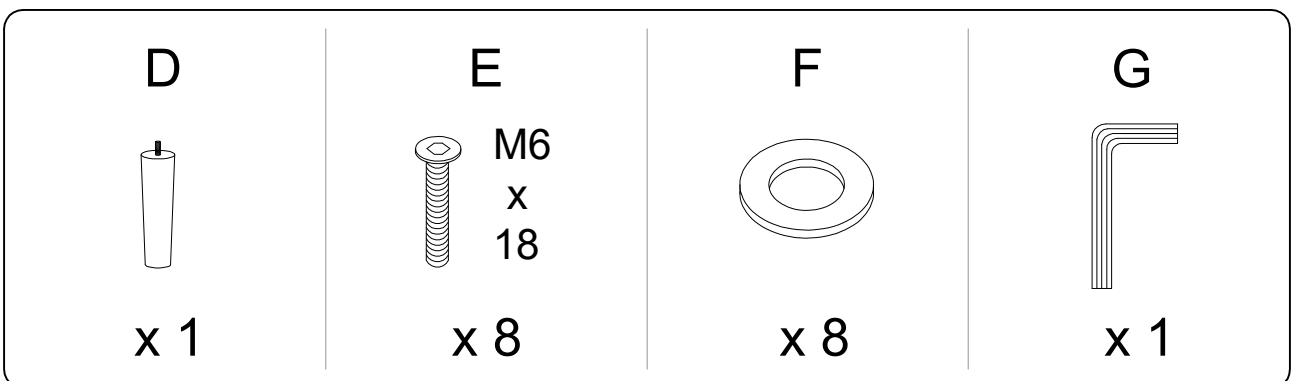

**D**

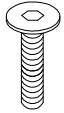
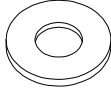
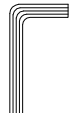

1

<b>B</b>  x 1	<b>C</b>  x 4	<b>D</b>  x 1	<b>E</b> M6 x 18  x 8	<b>F</b>  x 8	<b>G</b>  x 1
--	--	--	---	--	--

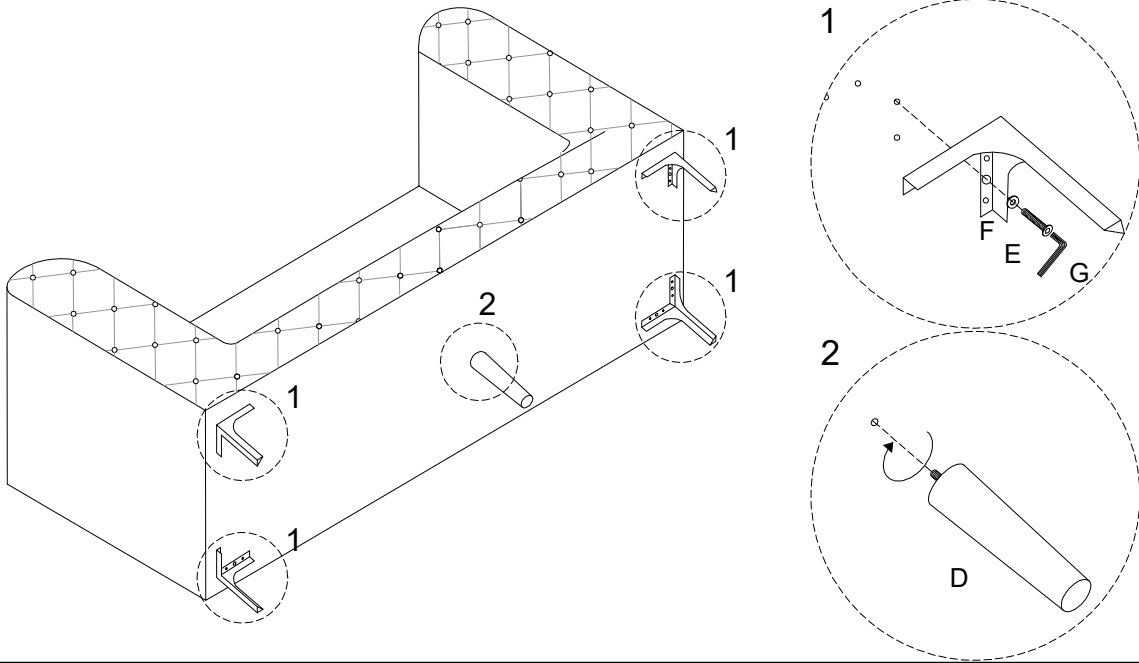

2

