

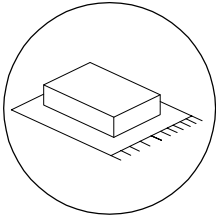

		<p>20'</p>
 		
		<p>1</p>

1/5

A	B	C	D	E
				
x 1	x 1	x 2	x 2	x 2

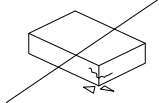
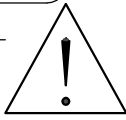
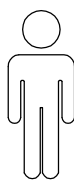
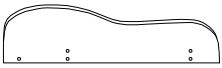
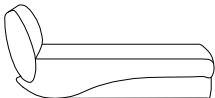
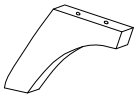

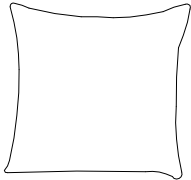
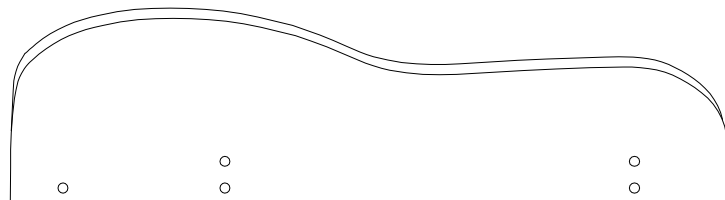
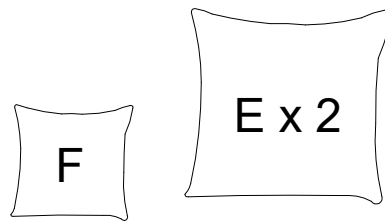
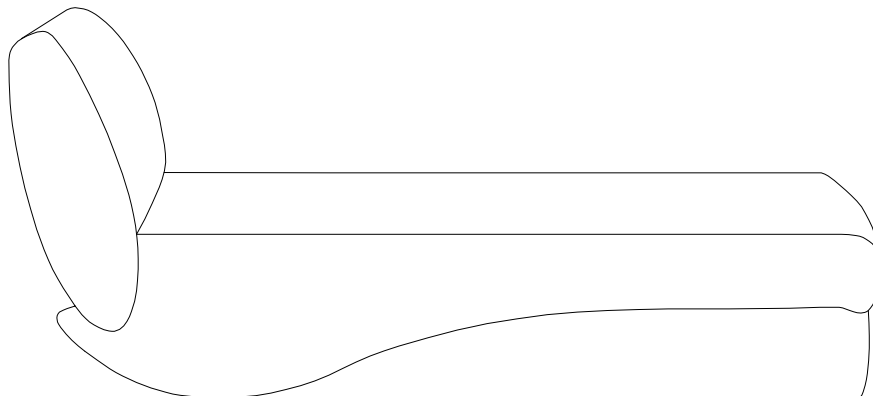
A



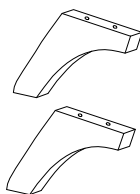

B



C x 2



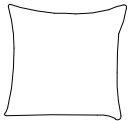
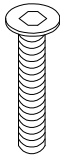
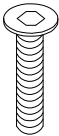
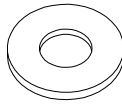

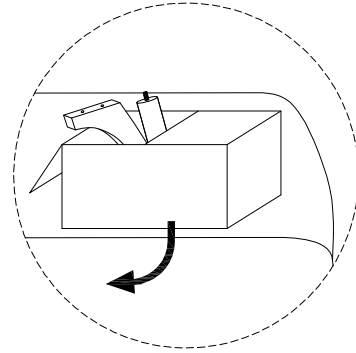
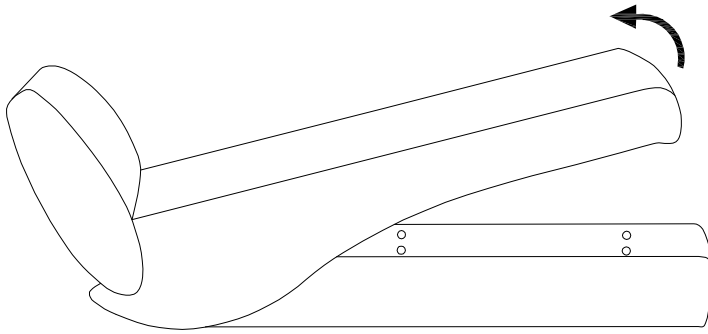

D x 2

F	G	H	I	J
	 M8 x 80	 M8 x 60		
x 1	x 2	x 7	x 9	x 1

!

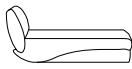

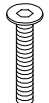
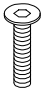
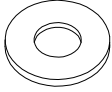
1

B  x 1	C  x 2	D  x 2	G  M8 x 80 x 2	H  M8 x 60 x 2	I  x 4	J  x 1
--	--	--	---	--	--	--

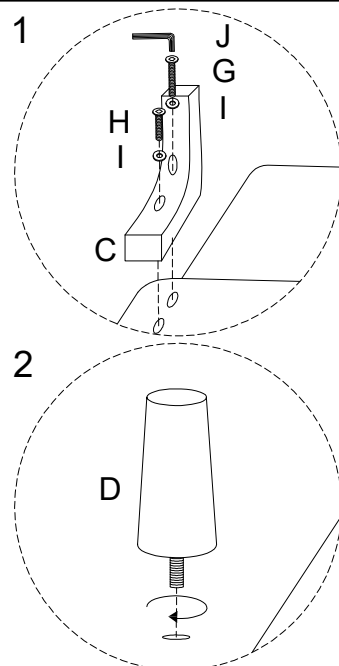
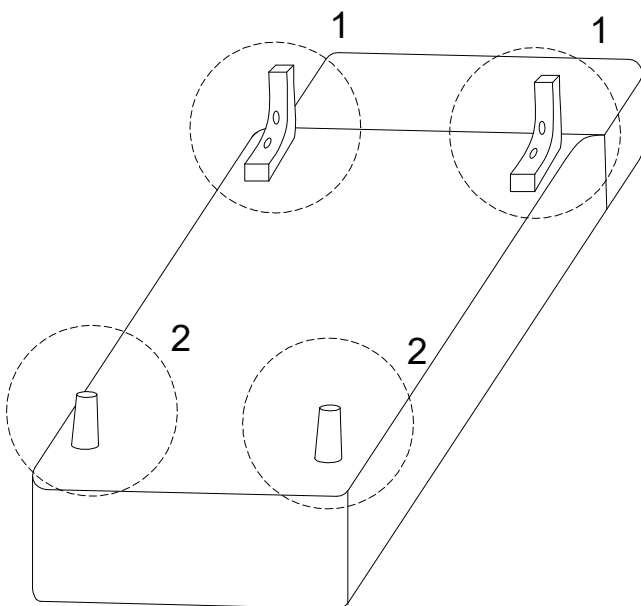

2

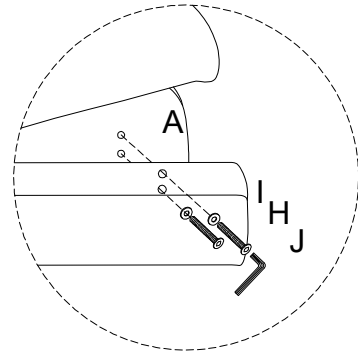
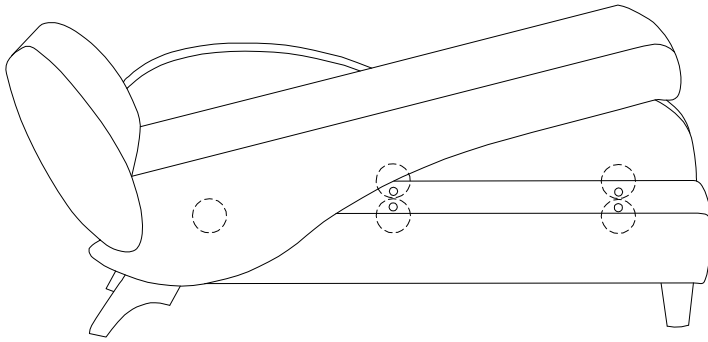
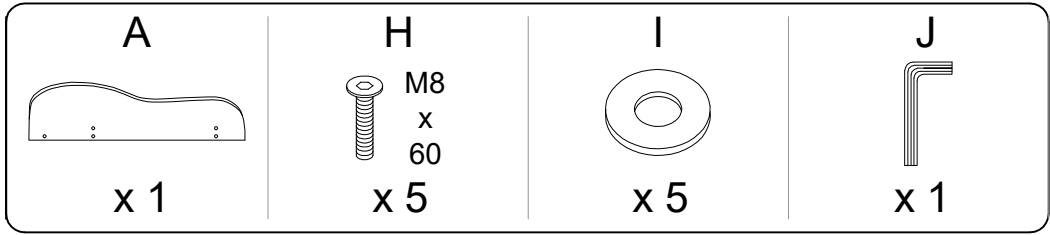

3

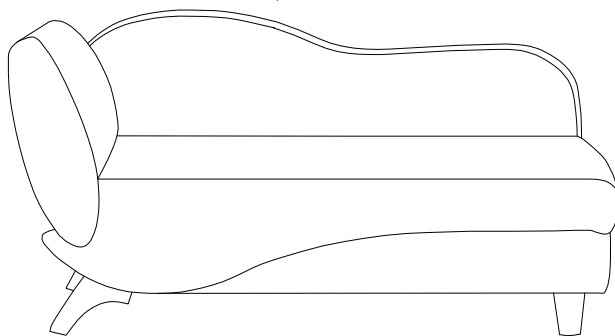
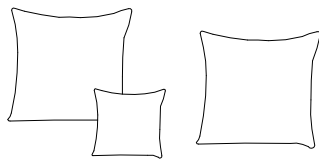
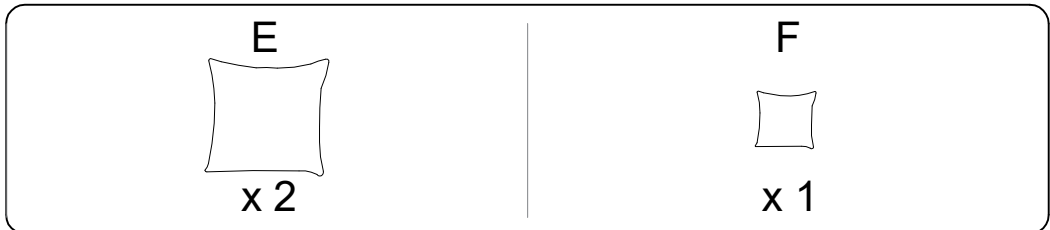

4

