

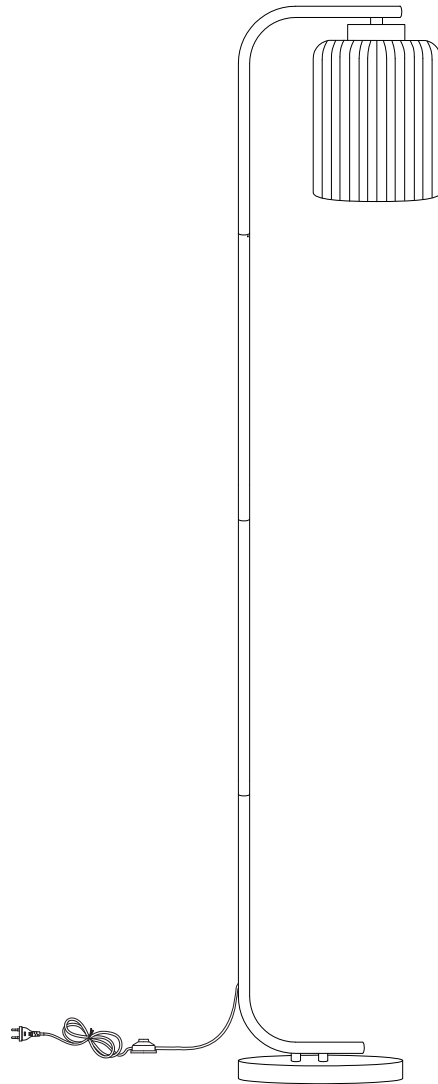

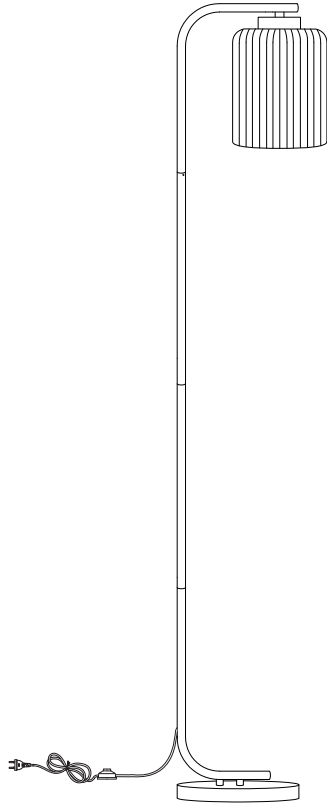

# CAUDELO

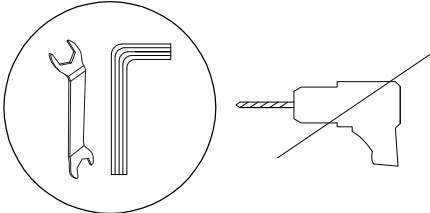

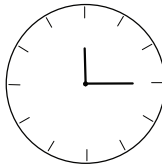
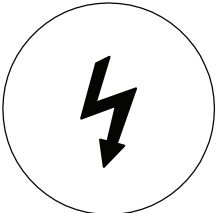

		
		<p>15'</p>
		
		<p>1</p>

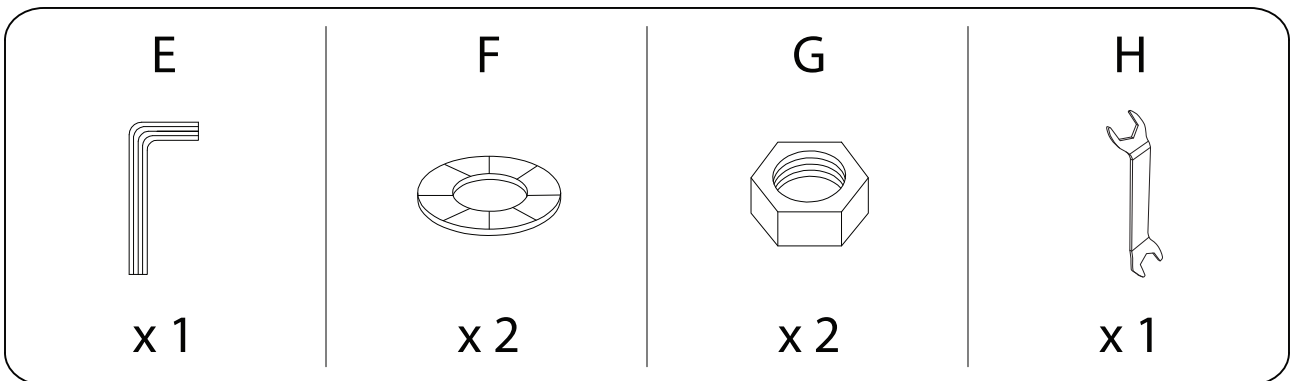
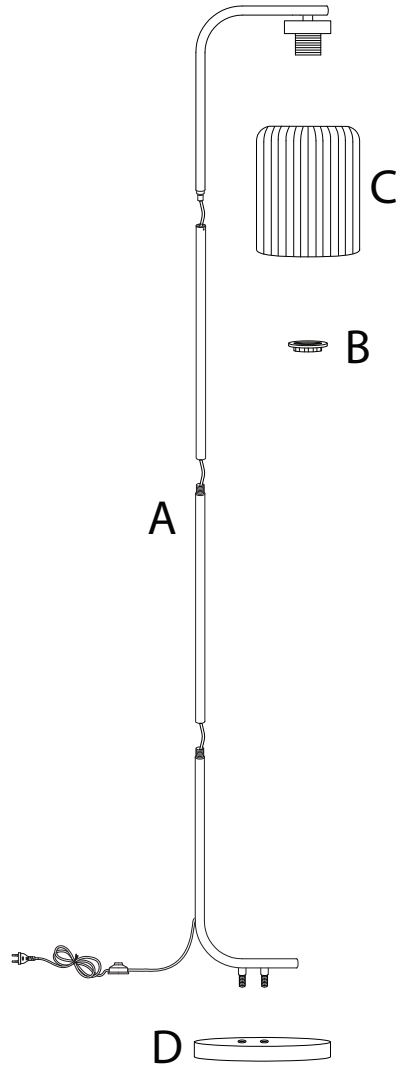
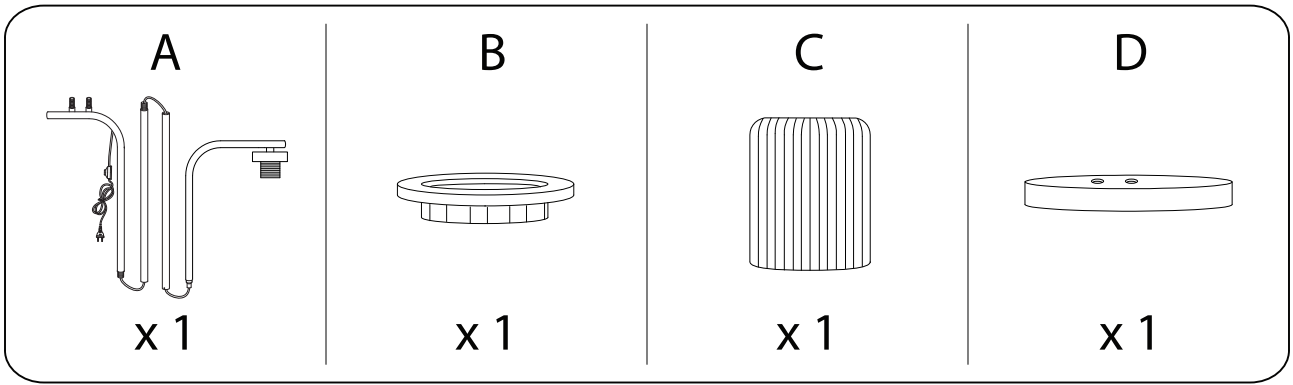

1

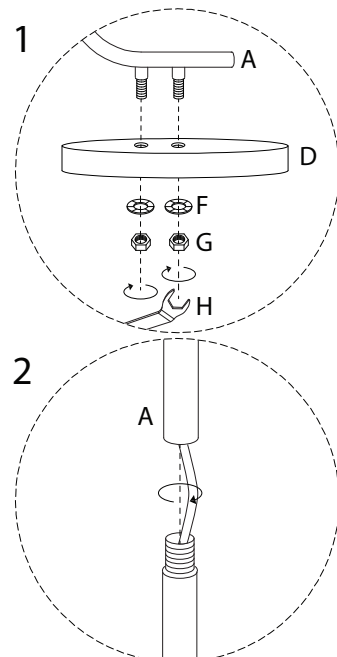
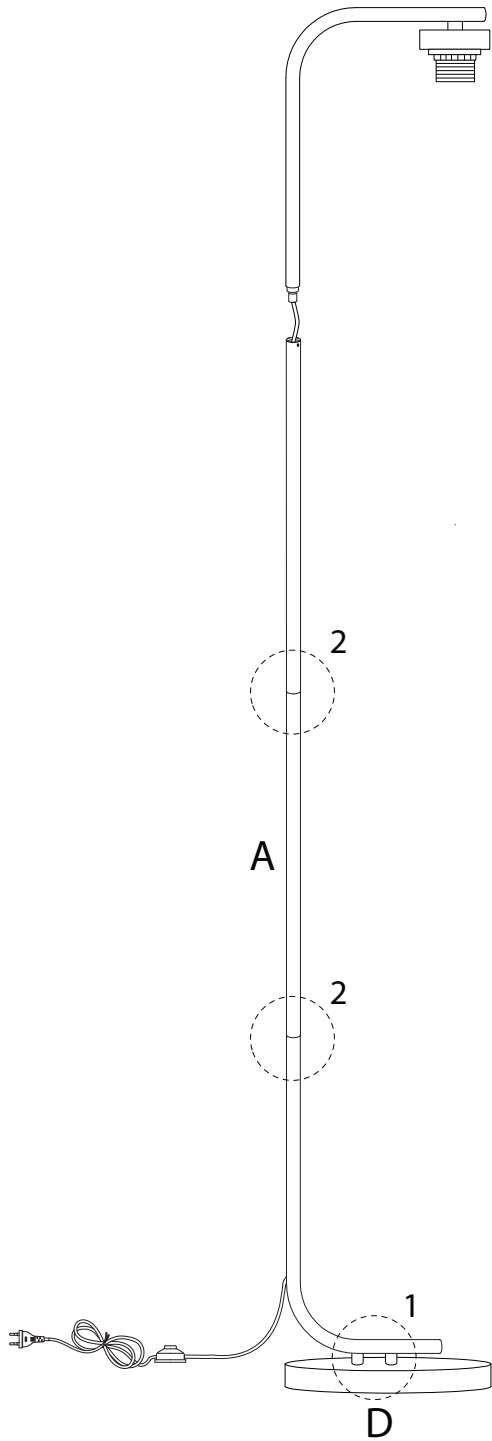
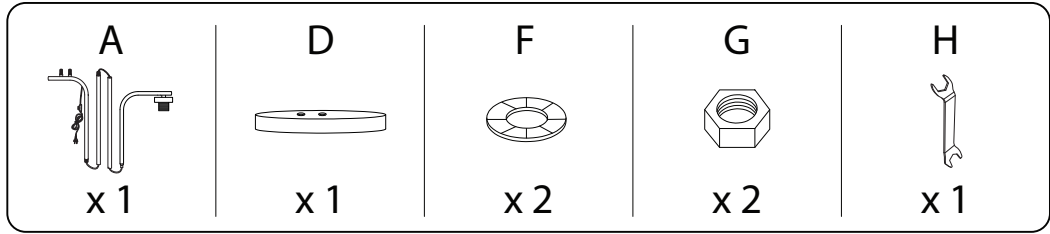

2

E  
x 1

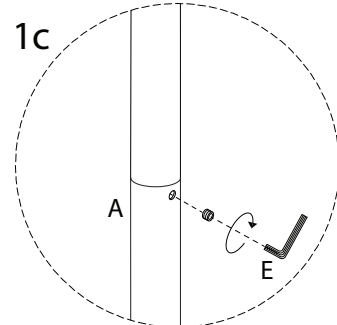
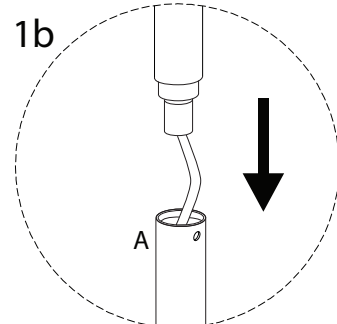
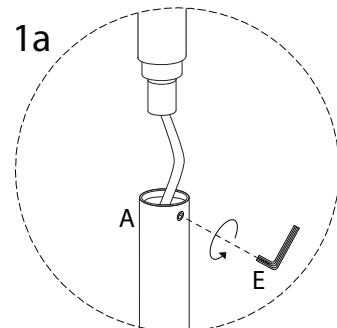
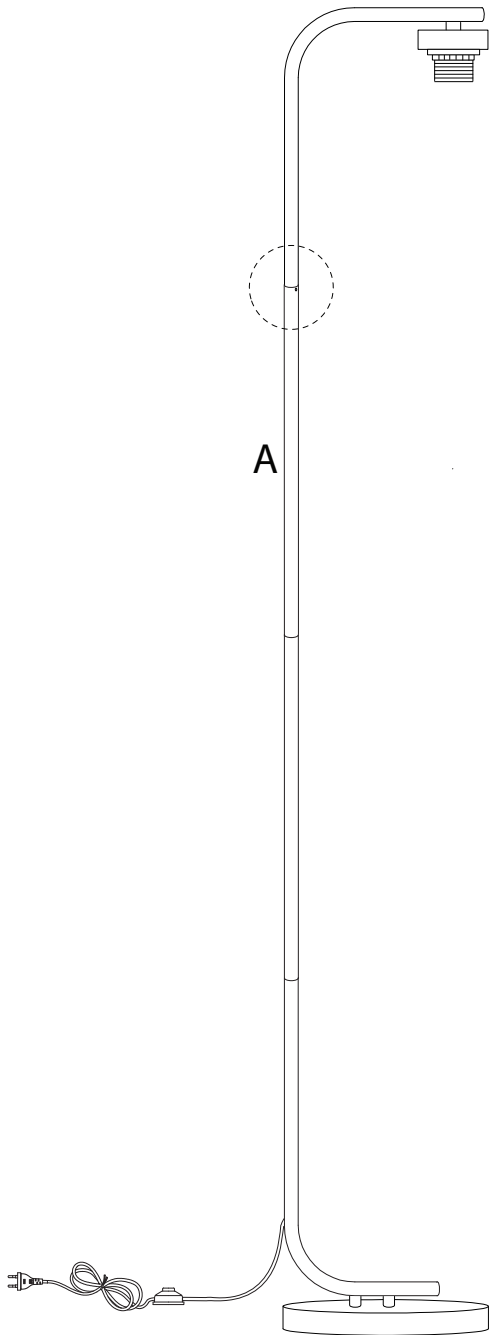

3

B

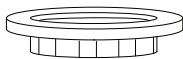

x 1

C

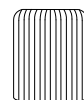

x 1

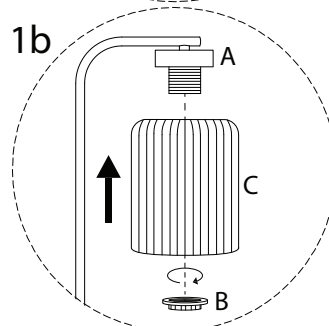
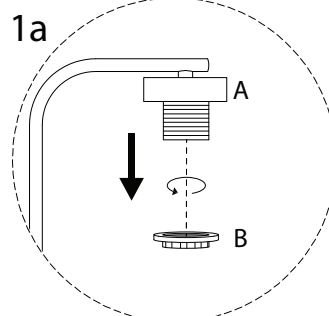
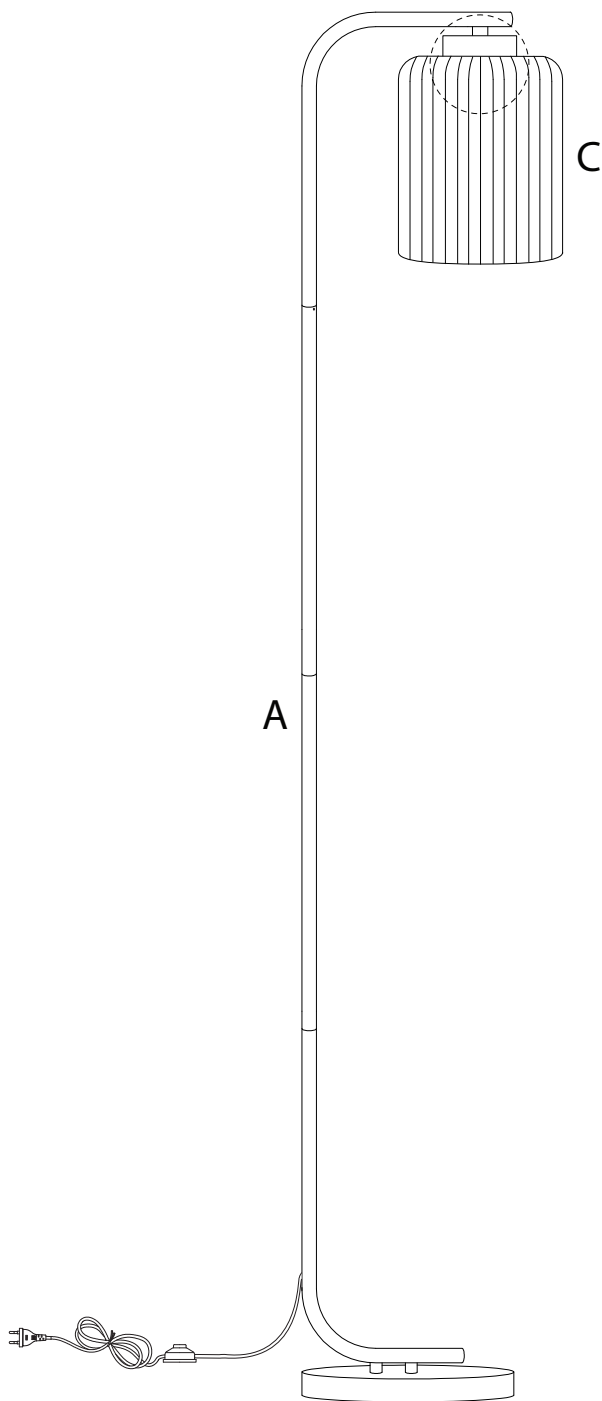

4

