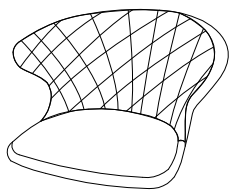

Diagram illustrating assembly steps and safety warnings:

- Step 1:** Shows an L-shaped bracket being inserted into a hole in the chair's frame. A power drill is shown with a diagonal line through it, indicating that a power drill should not be used for this step. A warning triangle with an exclamation mark is positioned above this step.
- Step 2:** Shows a rectangular block being placed on a textured surface. A power drill is shown with a diagonal line through it, indicating that a power drill should not be used for this step. A warning triangle with an exclamation mark is positioned above this step.
- Time:** A clock icon is shown next to the text "20'", indicating a 20-minute assembly time.
- Person:** A person icon is shown next to the number "1", indicating that one person is required for assembly.

A



x 1

B

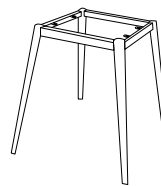

x 1

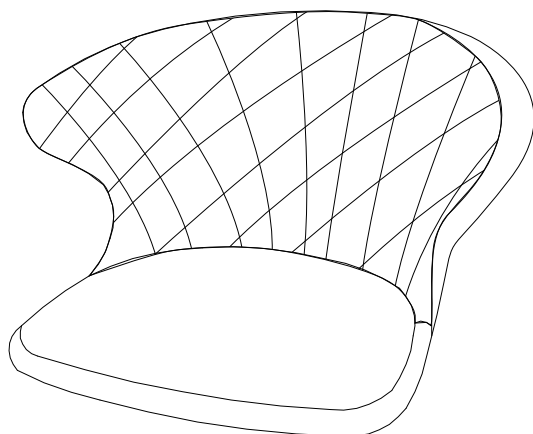

A

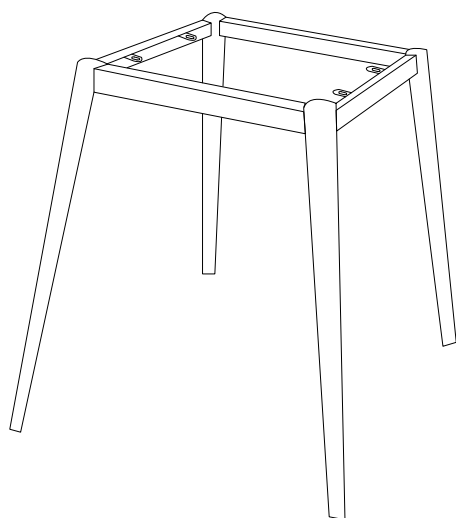

B

C

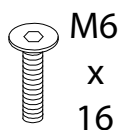

x 4

D

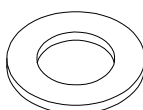

x 4

E

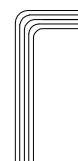

x 1

1

