

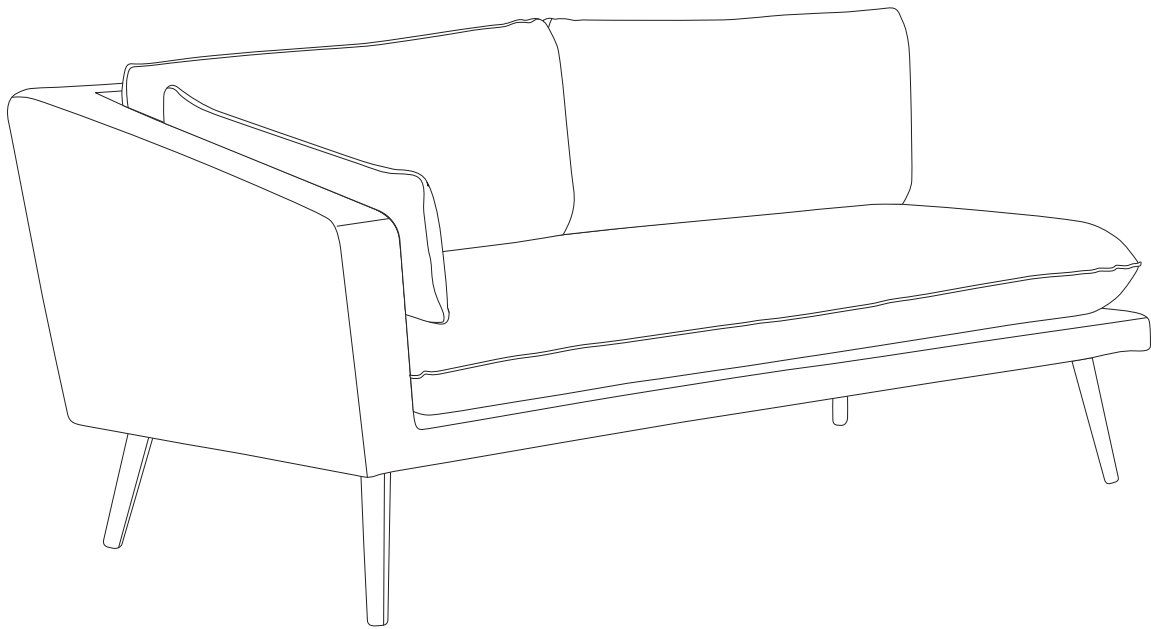

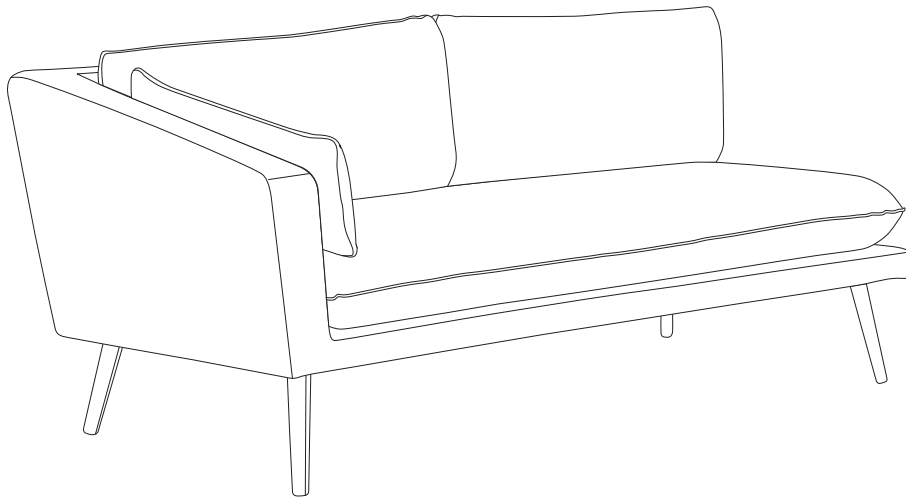

# LORETELLO





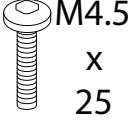
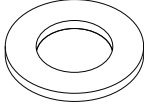



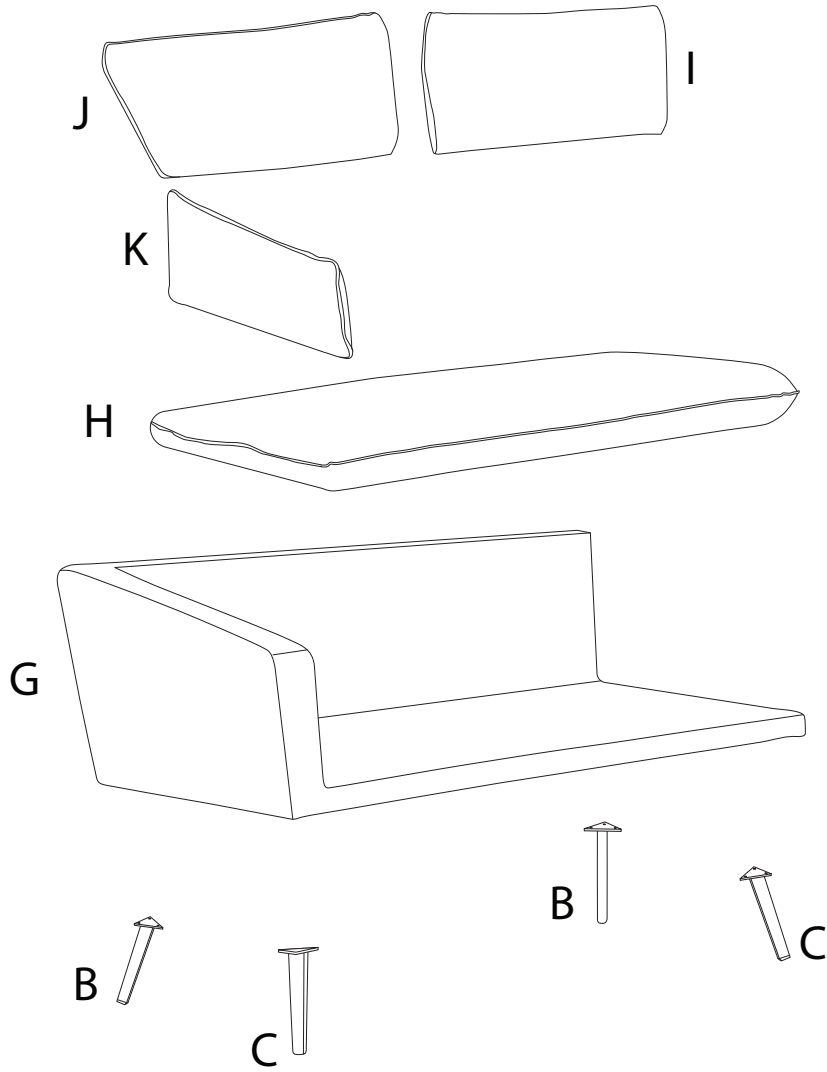

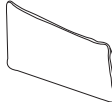
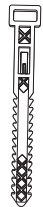

		<p>10'</p>
		<p>1</p>

<b>B</b>	<b>C</b>	<b>D</b>	<b>E</b>	<b>F</b>
		 M4.5 x 25		
x 2	x 2	x 12	x 12	x 1



<b>G</b>	<b>H</b>	<b>I</b>	<b>J</b>	<b>K</b>	<b>L</b>
					
x 1	x 1	x 1	x 1	x 1	x 1

1

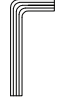
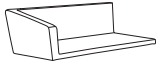
<b>B</b>  x 2	<b>C</b>  x 2	<b>D</b>  M4.5 x 25 x 12	<b>E</b>  x 12	<b>F</b>  x 1	<b>G</b>  x 1
--	--	---	--	--	--

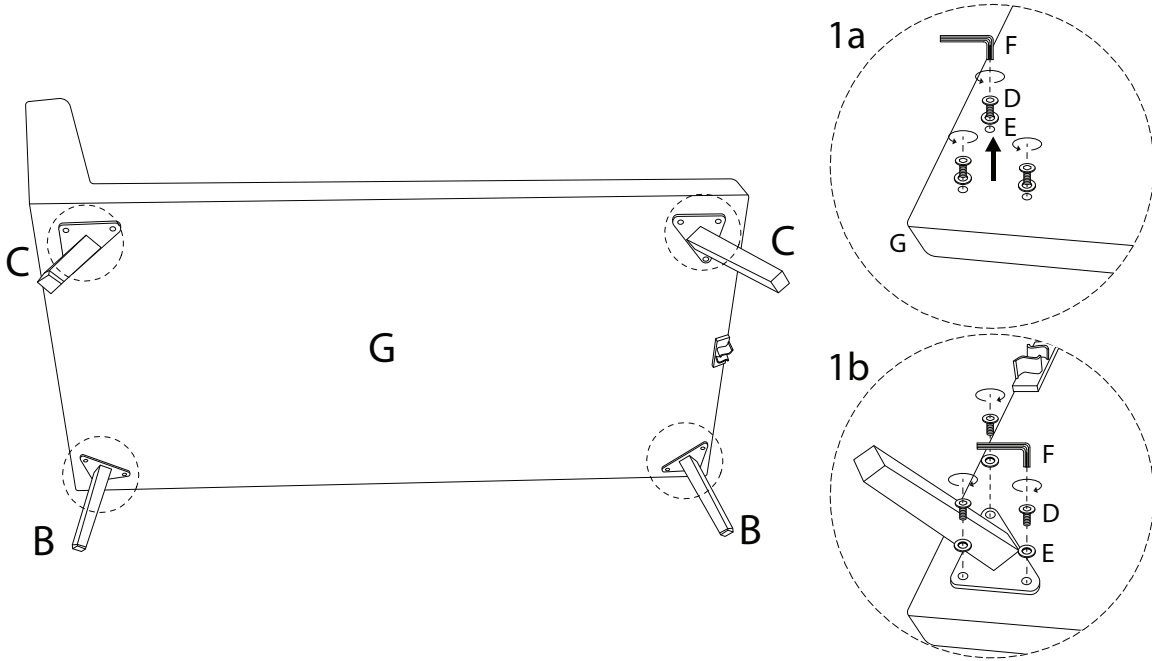

2

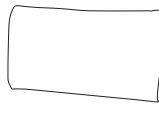
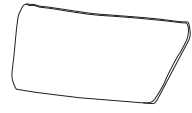
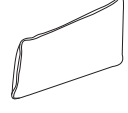
<b>H</b>  x 1	<b>I</b>  x 1	<b>J</b>  x 1	<b>K</b>  x 1
--	--	---	--

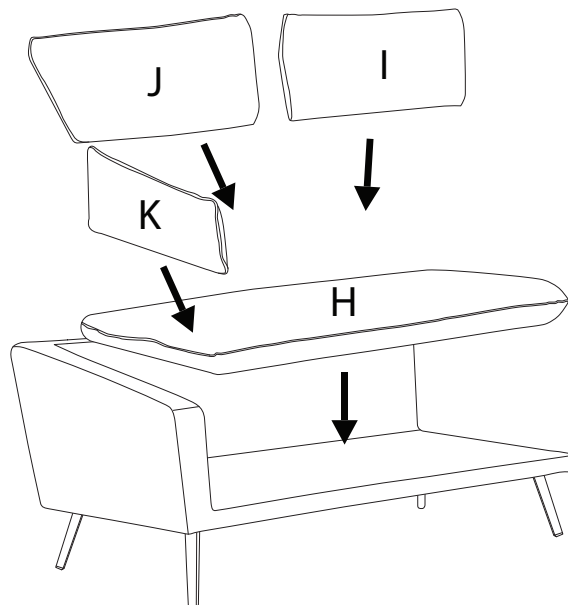

3

