

# CAPELLA

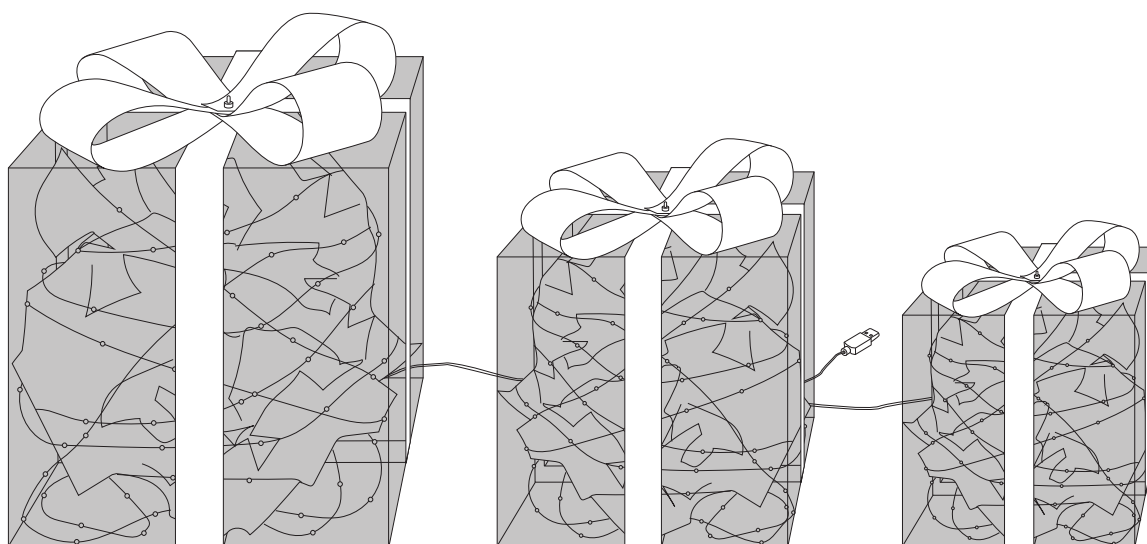

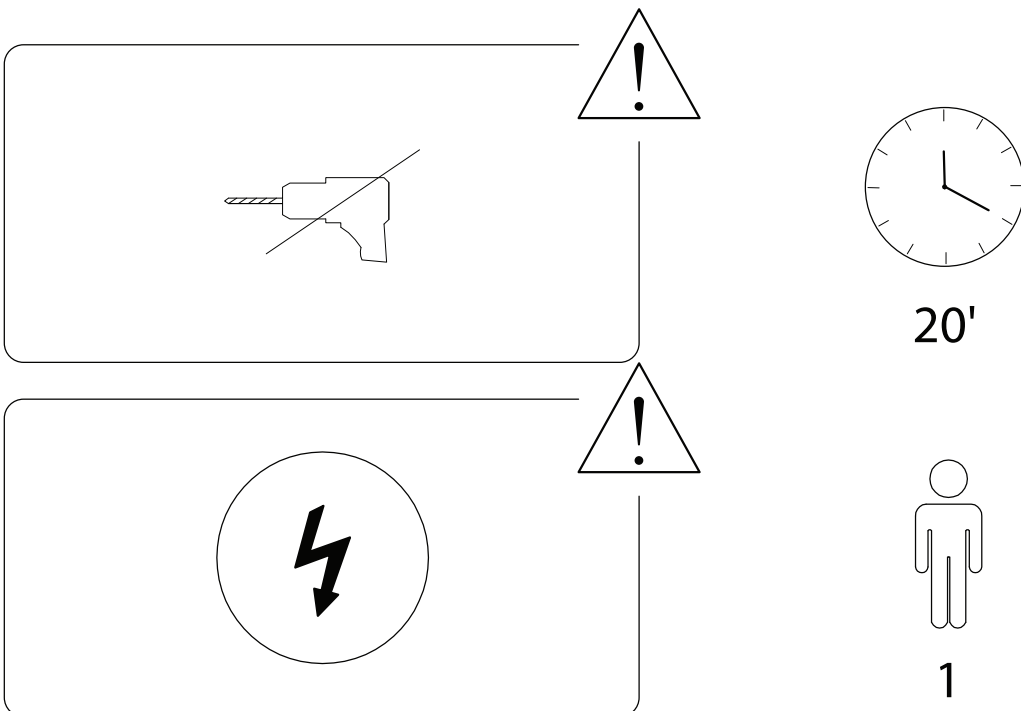

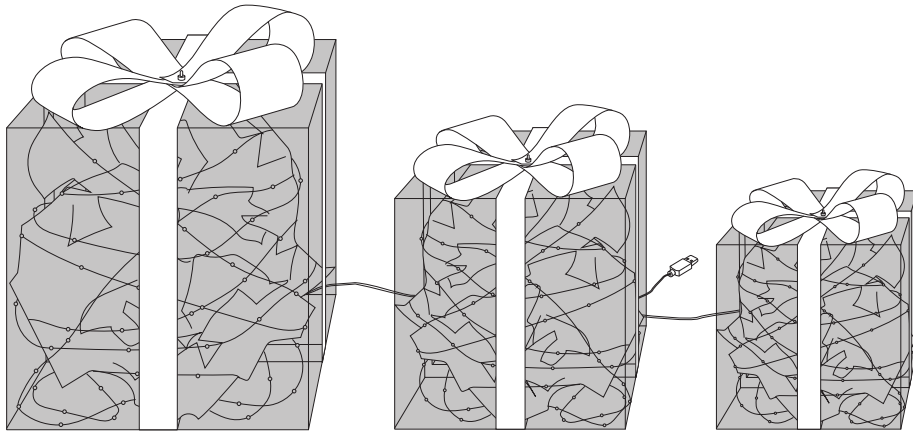
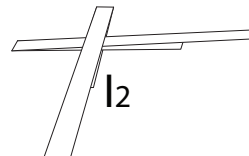
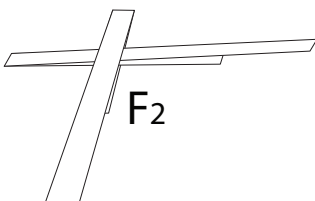
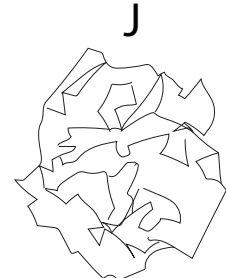
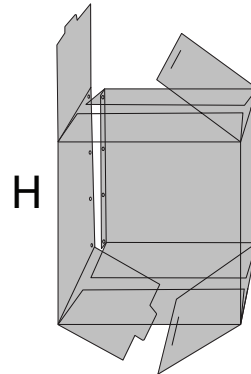
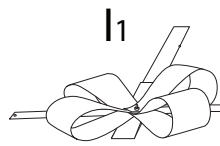
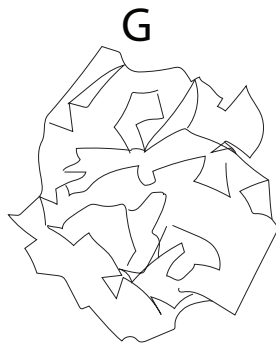
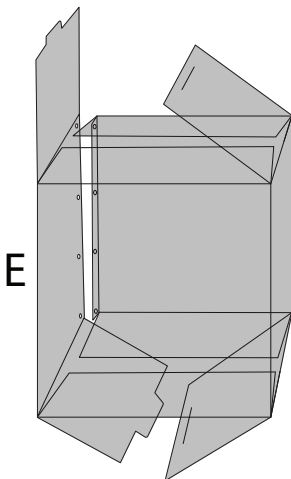
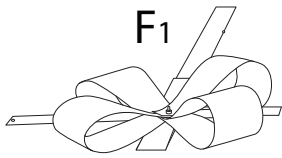
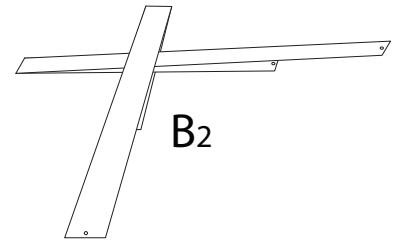
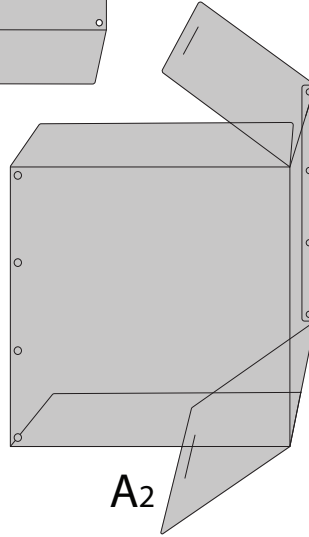
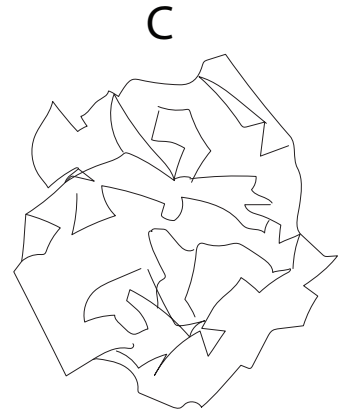
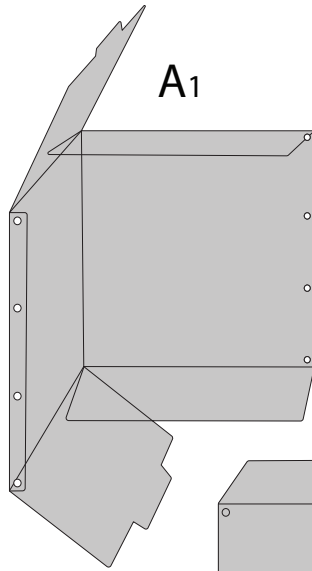
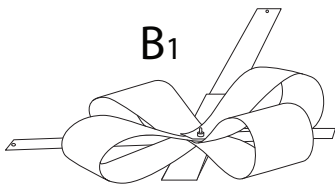

A<sub>1</sub>

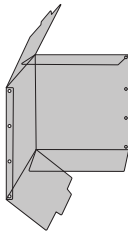

x 1

A<sub>2</sub>

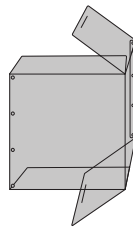

x 1

B<sub>1</sub>

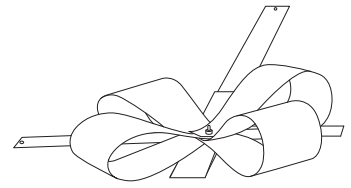

x 1

B<sub>2</sub>

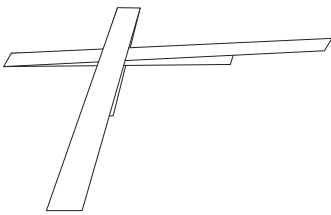

x 1

C

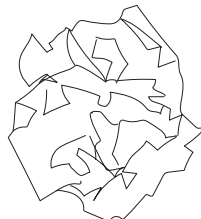

x 1

D



x 1

E

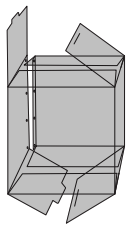

x 1

F<sub>1</sub>

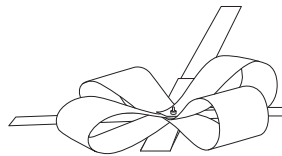

x 1

F<sub>2</sub>

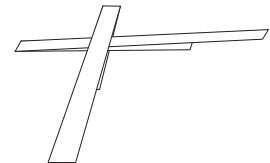

x 1

G



x 1

H

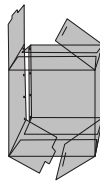

x 1

I<sub>1</sub>

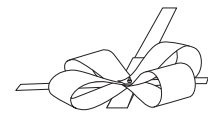

x 1

I<sub>2</sub>

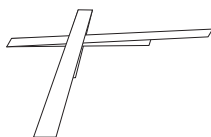

x 1

J



x 1

!

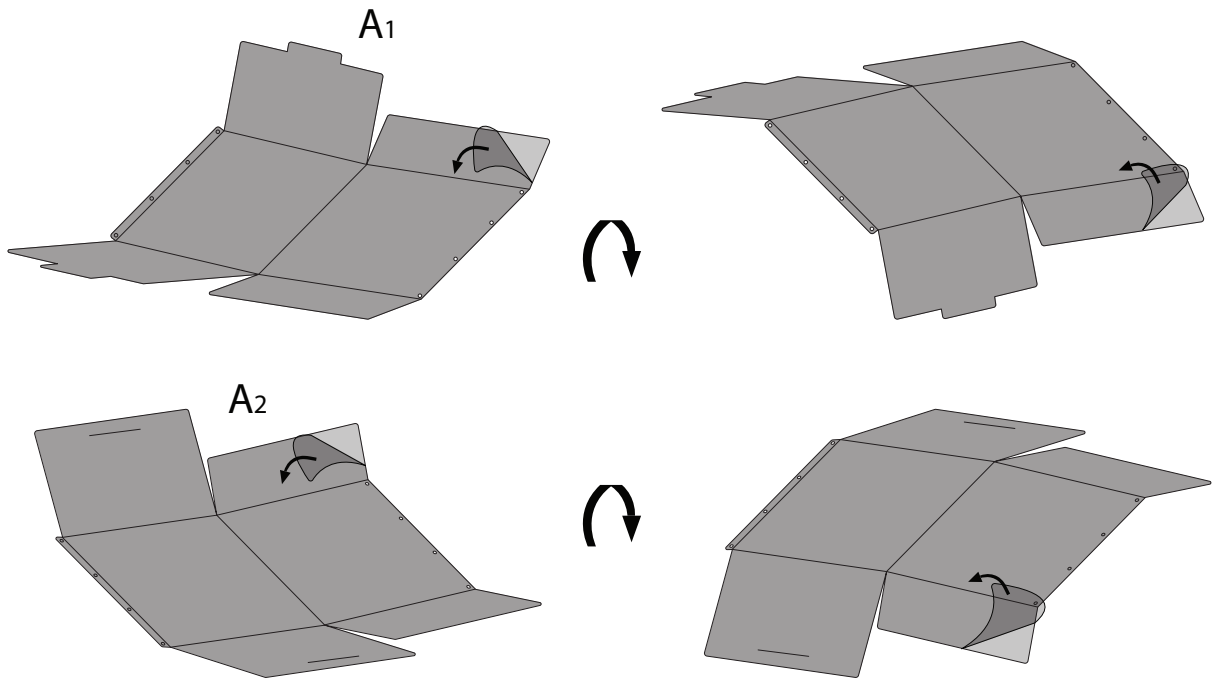

1

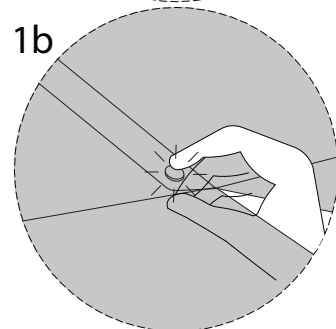
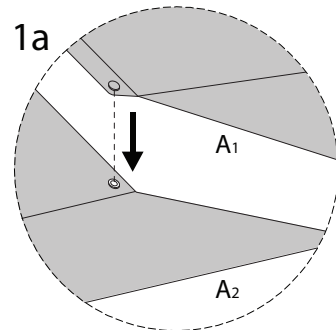
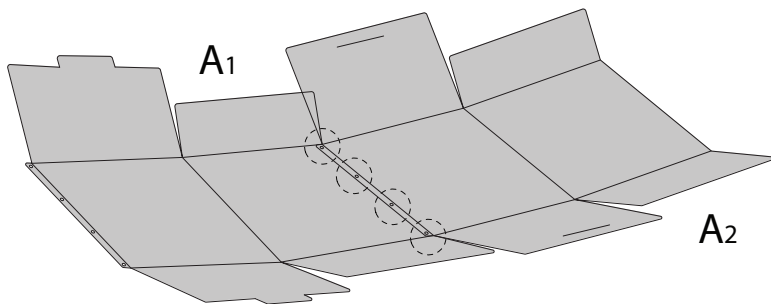
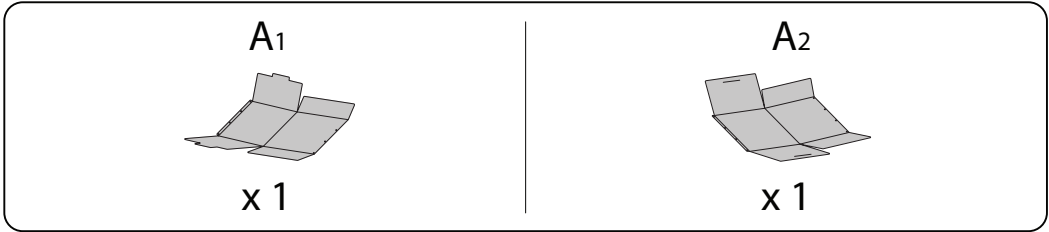

2

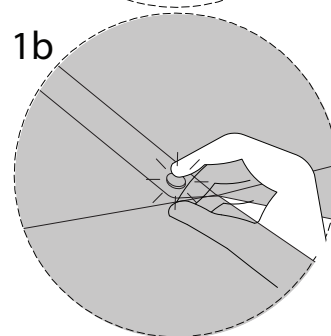
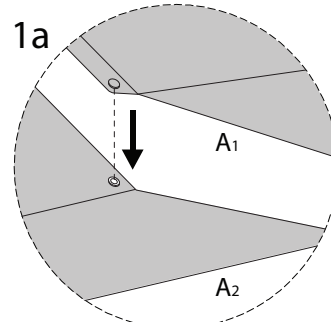
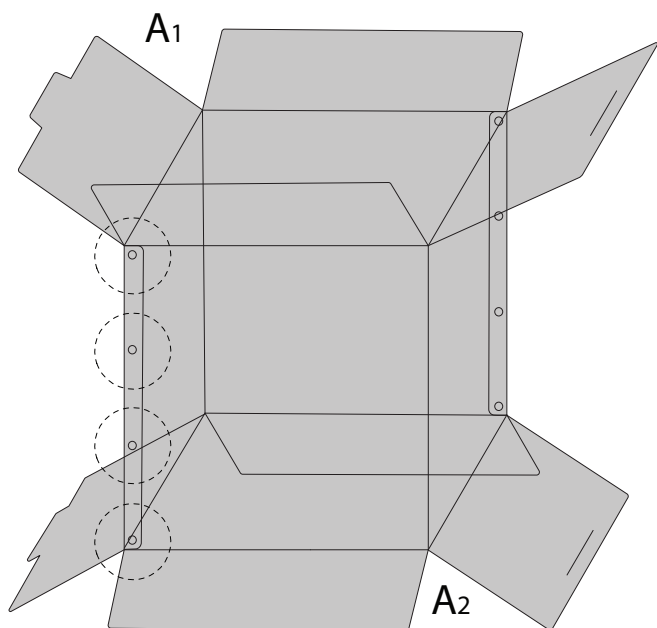

3

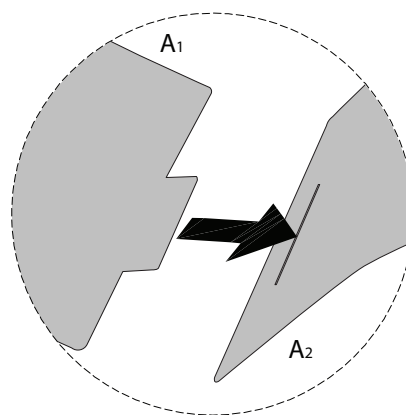
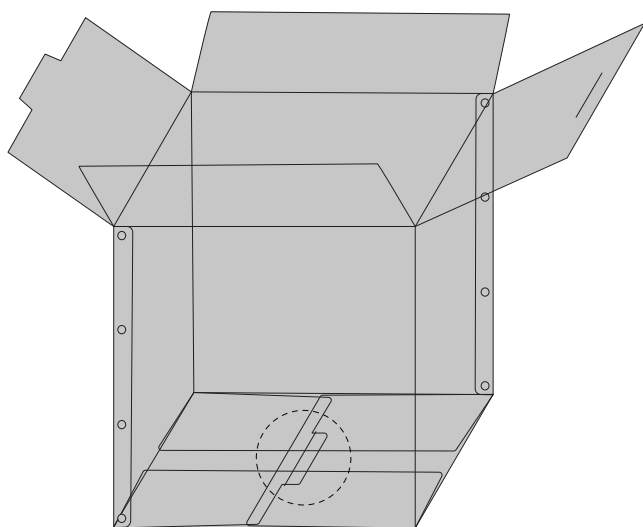

!

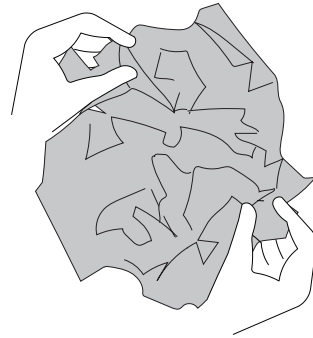
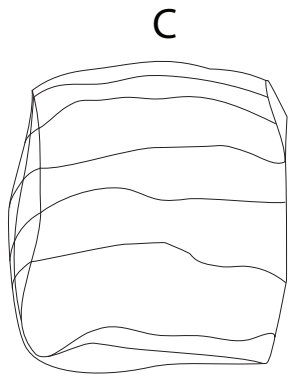

4

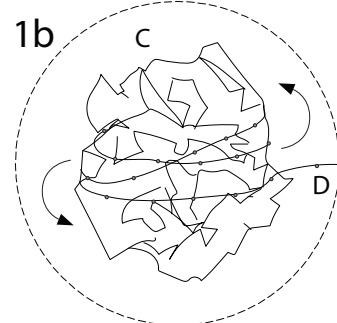
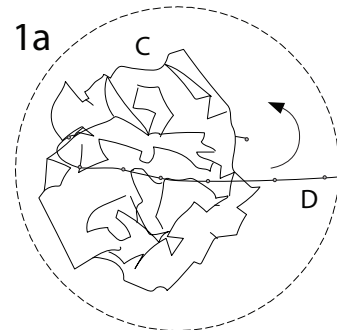
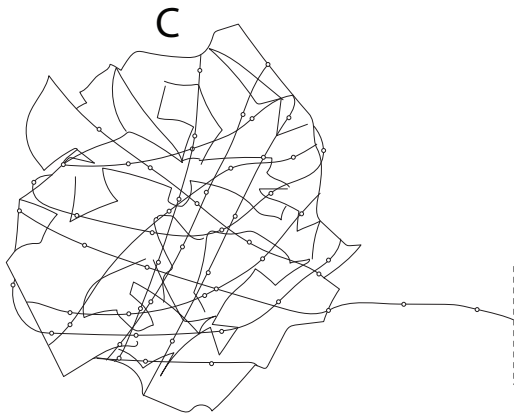
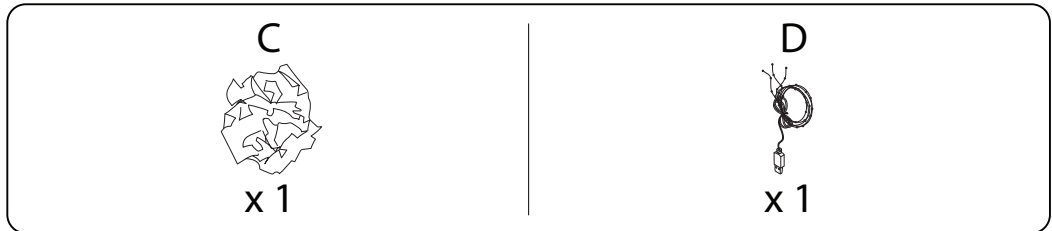

5

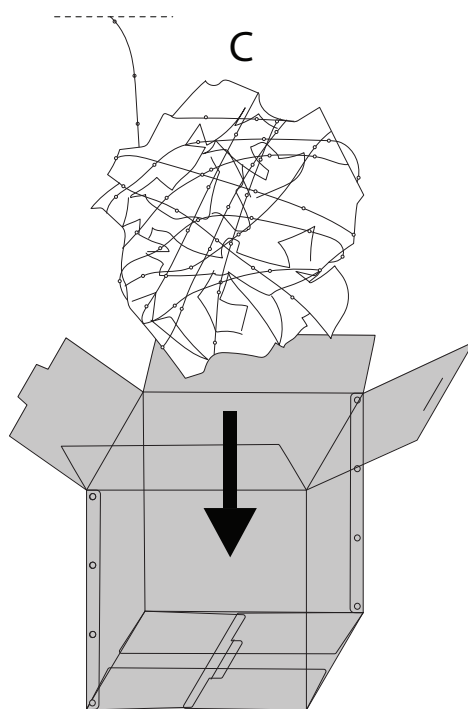

6

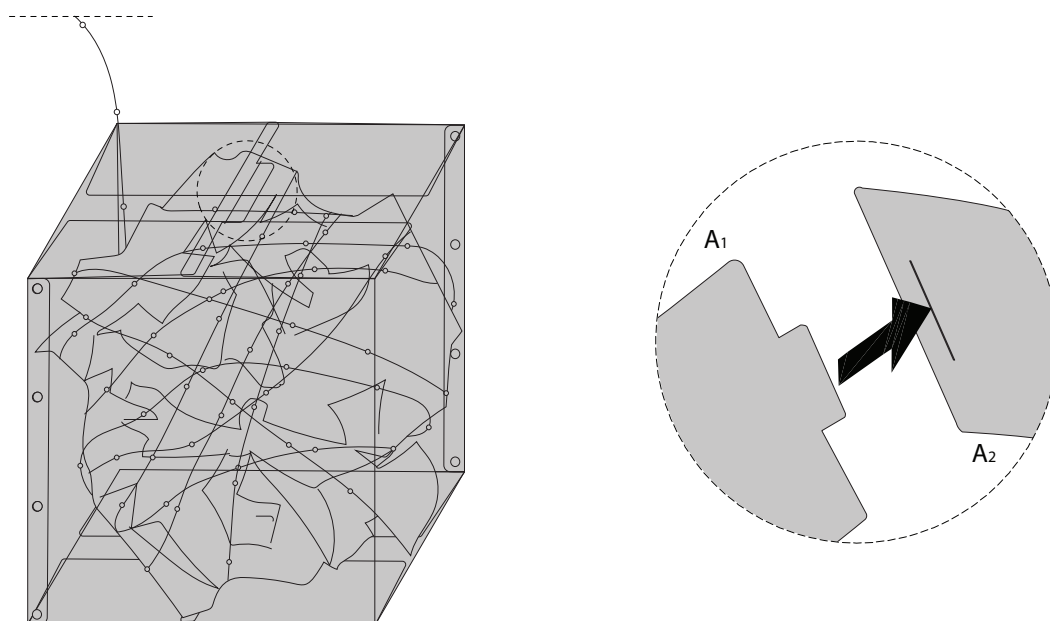



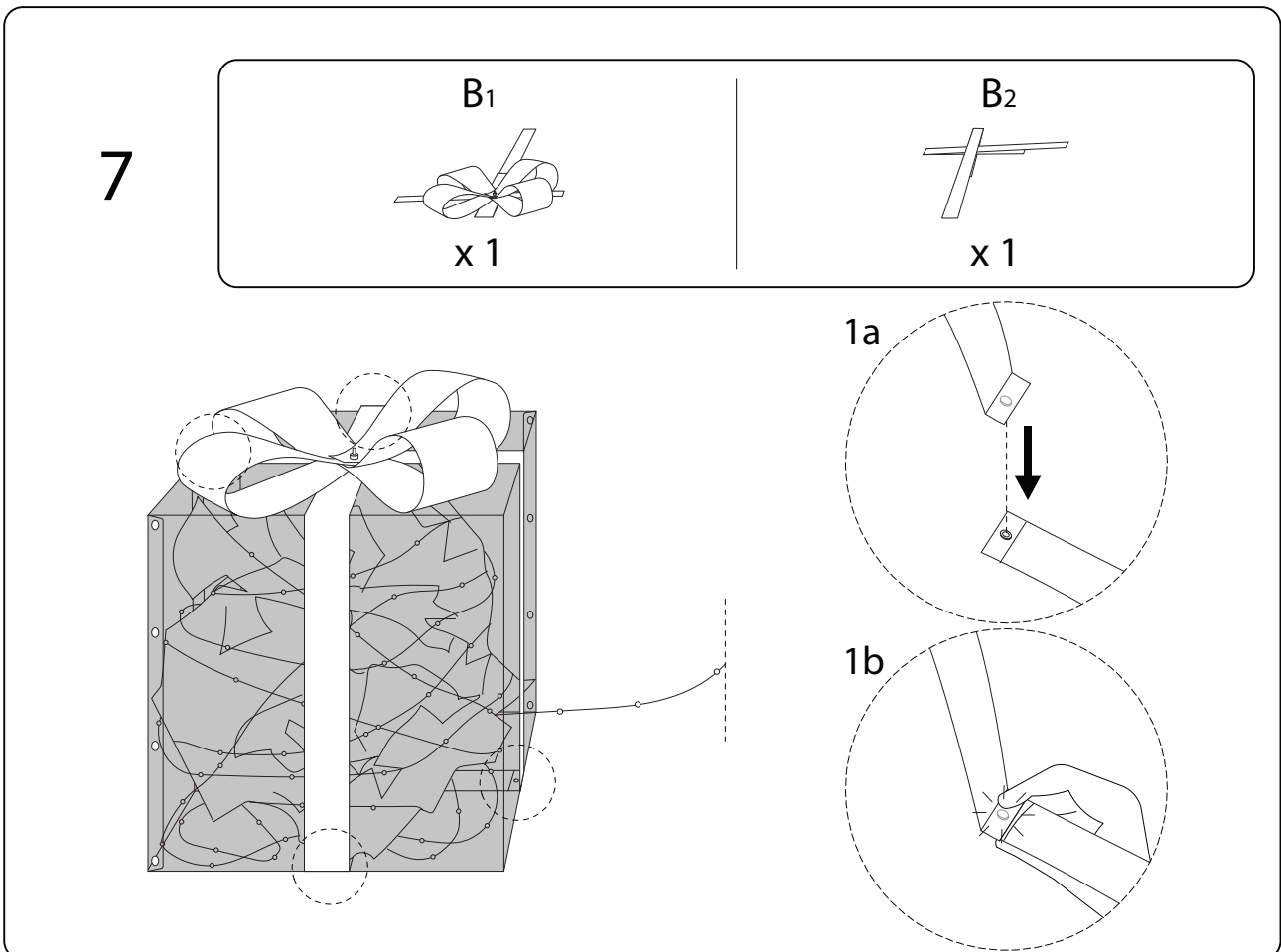
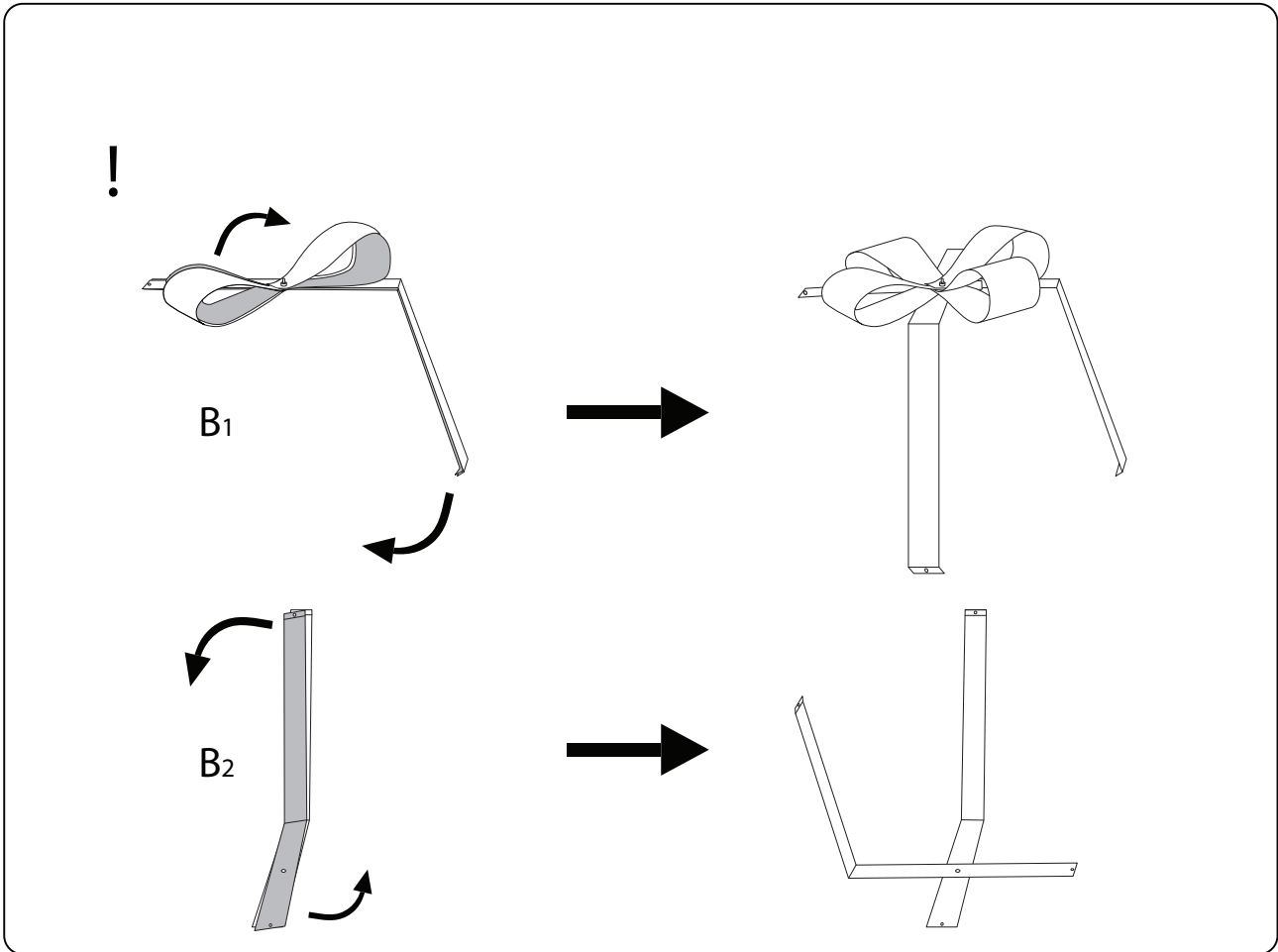

!

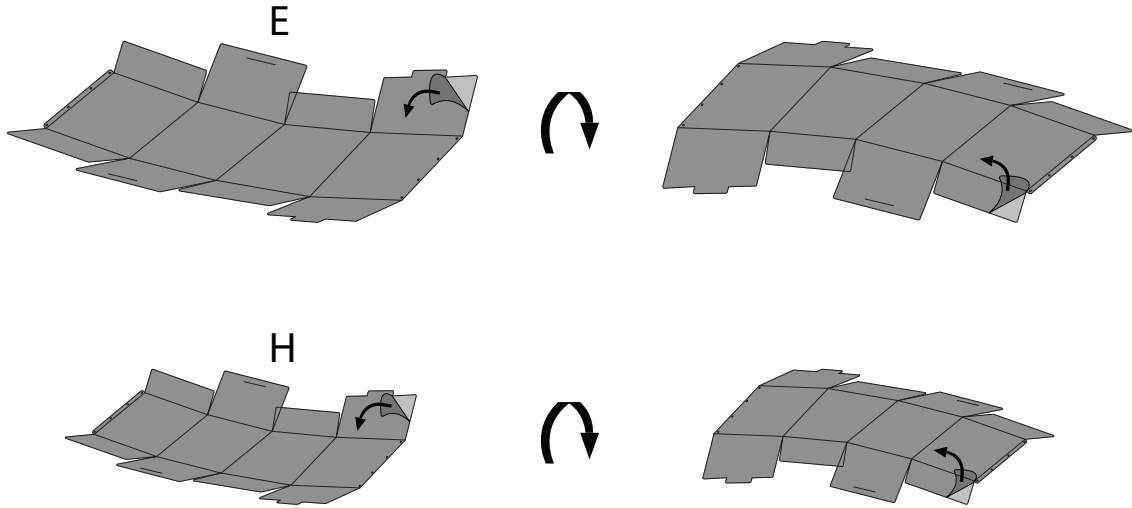

8

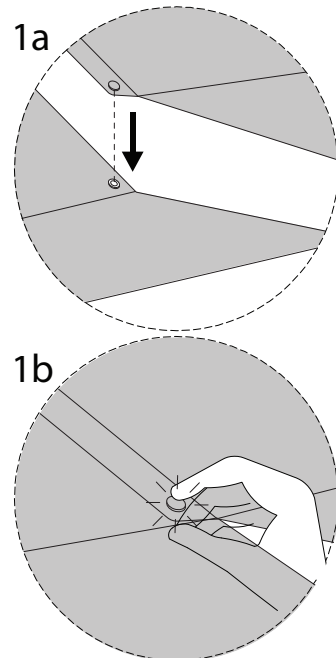
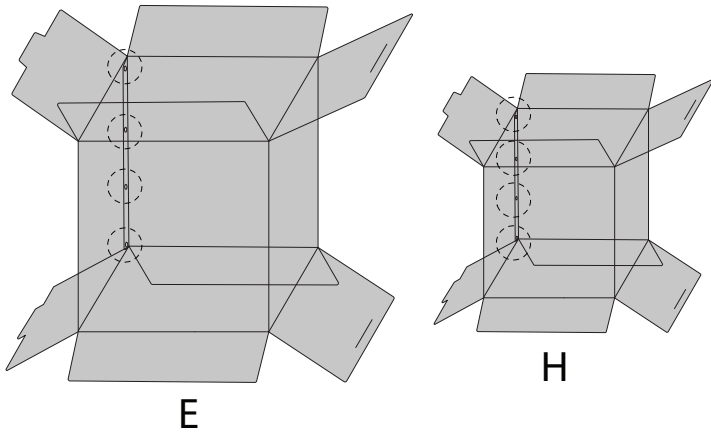
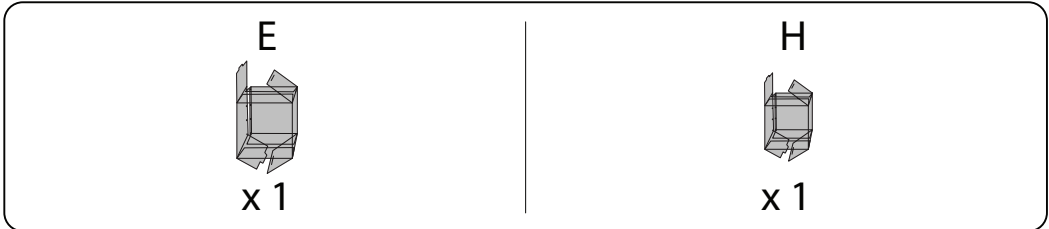

9

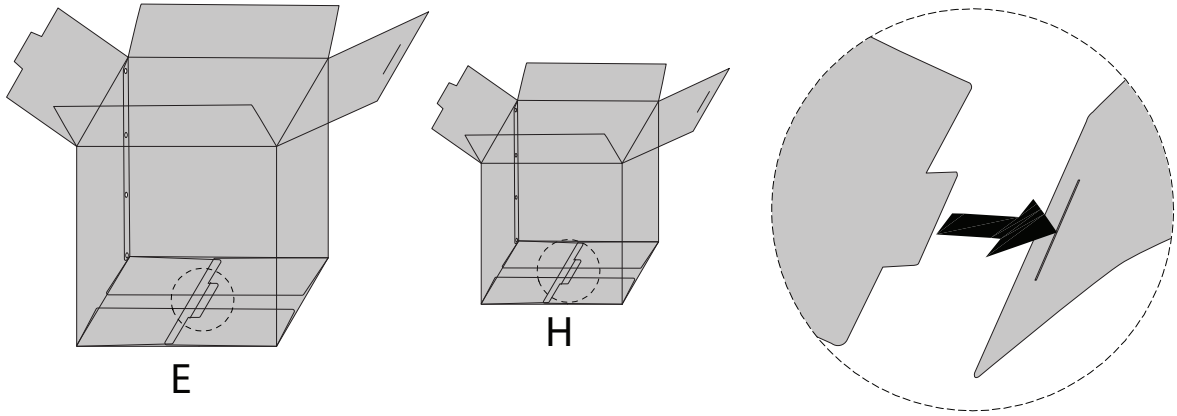

!

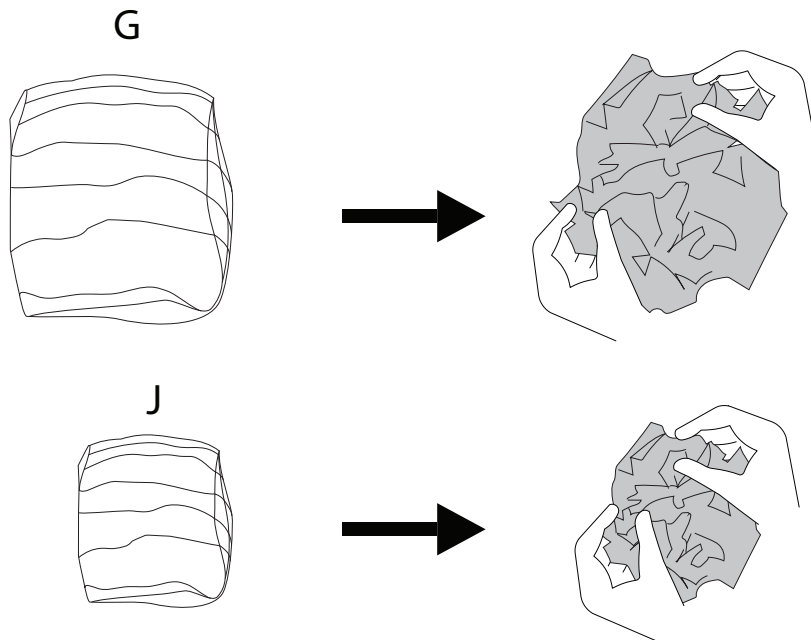

10

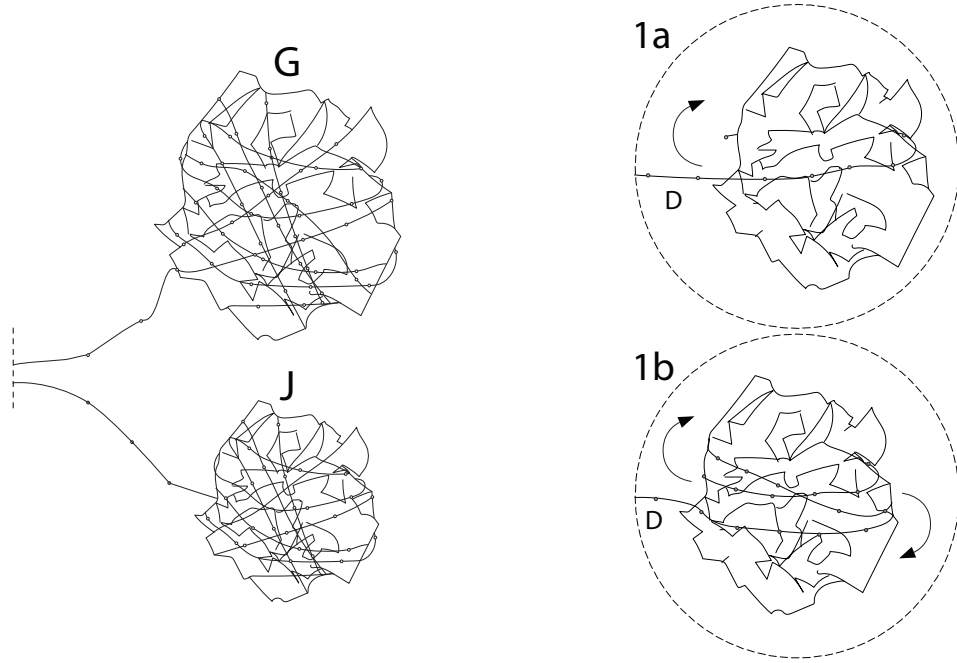
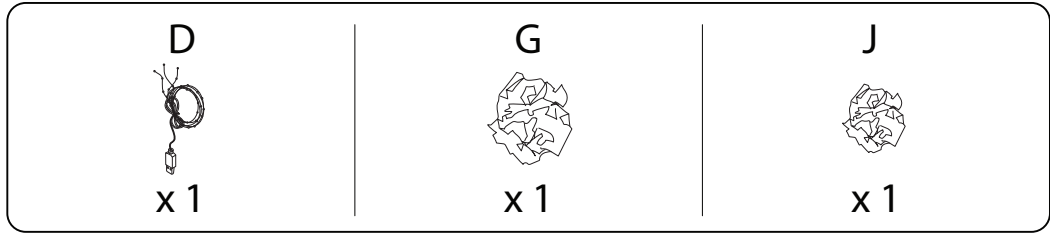

11

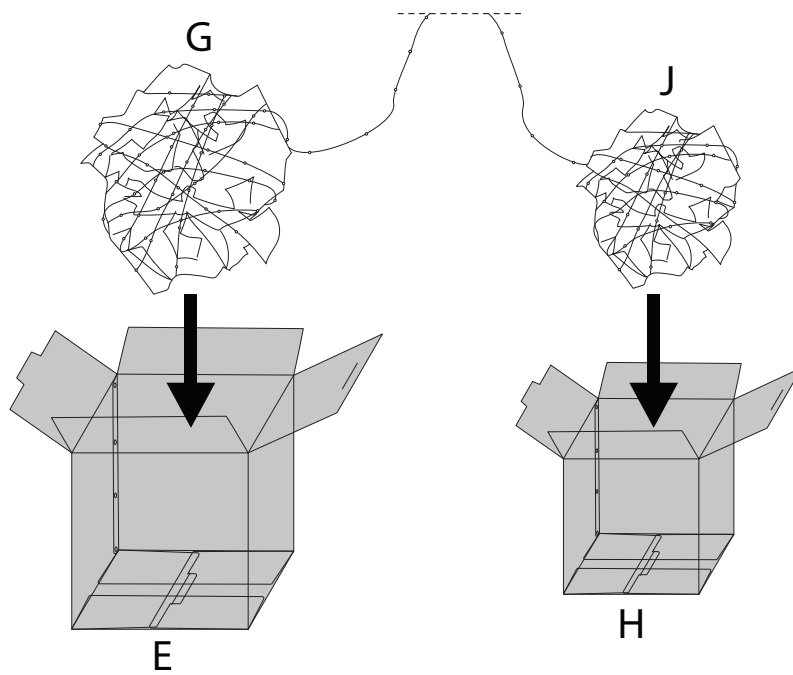

12

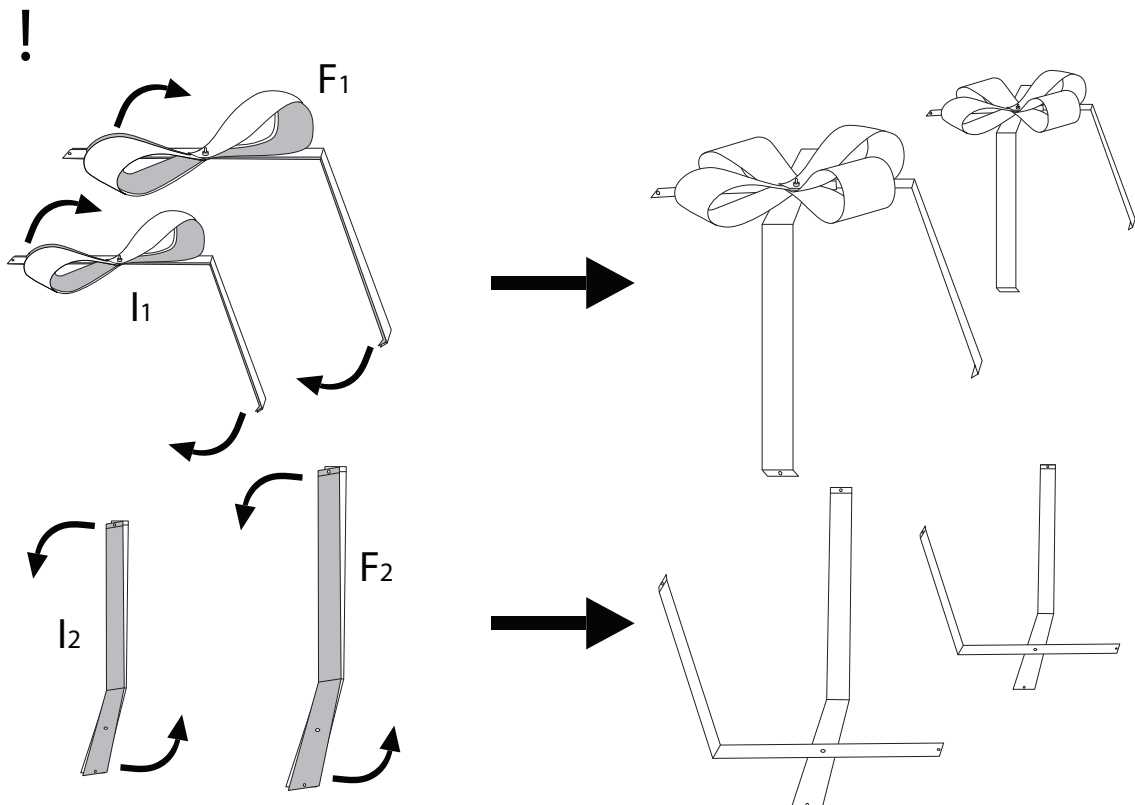
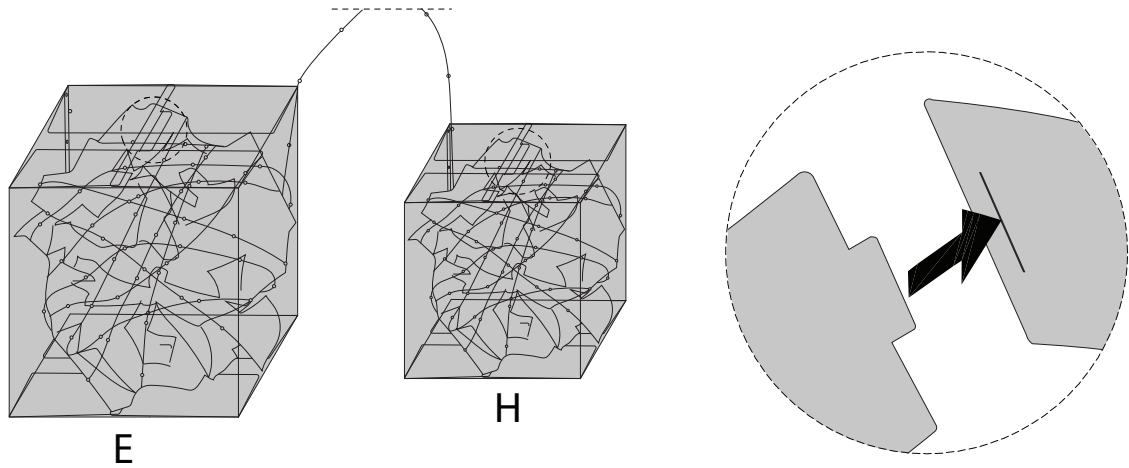

13

