

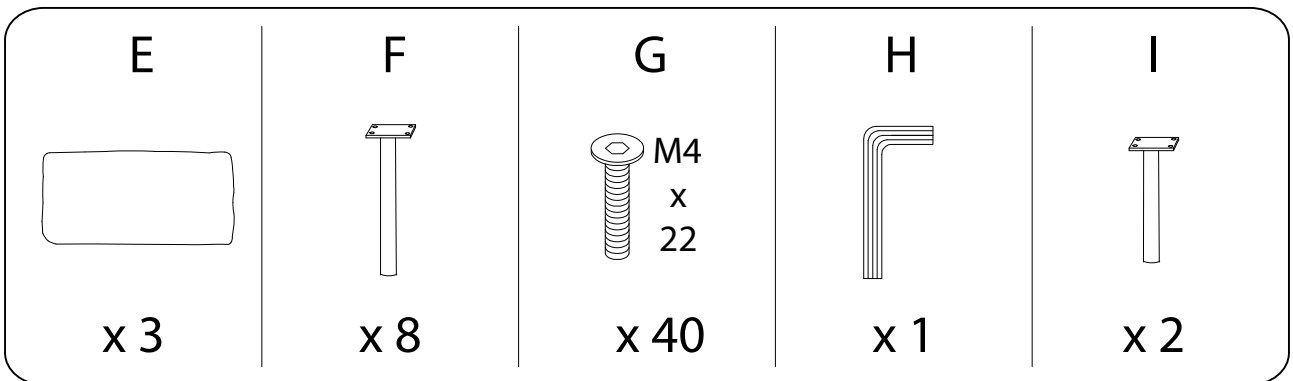

<p>15'</p>		<p>1</p>

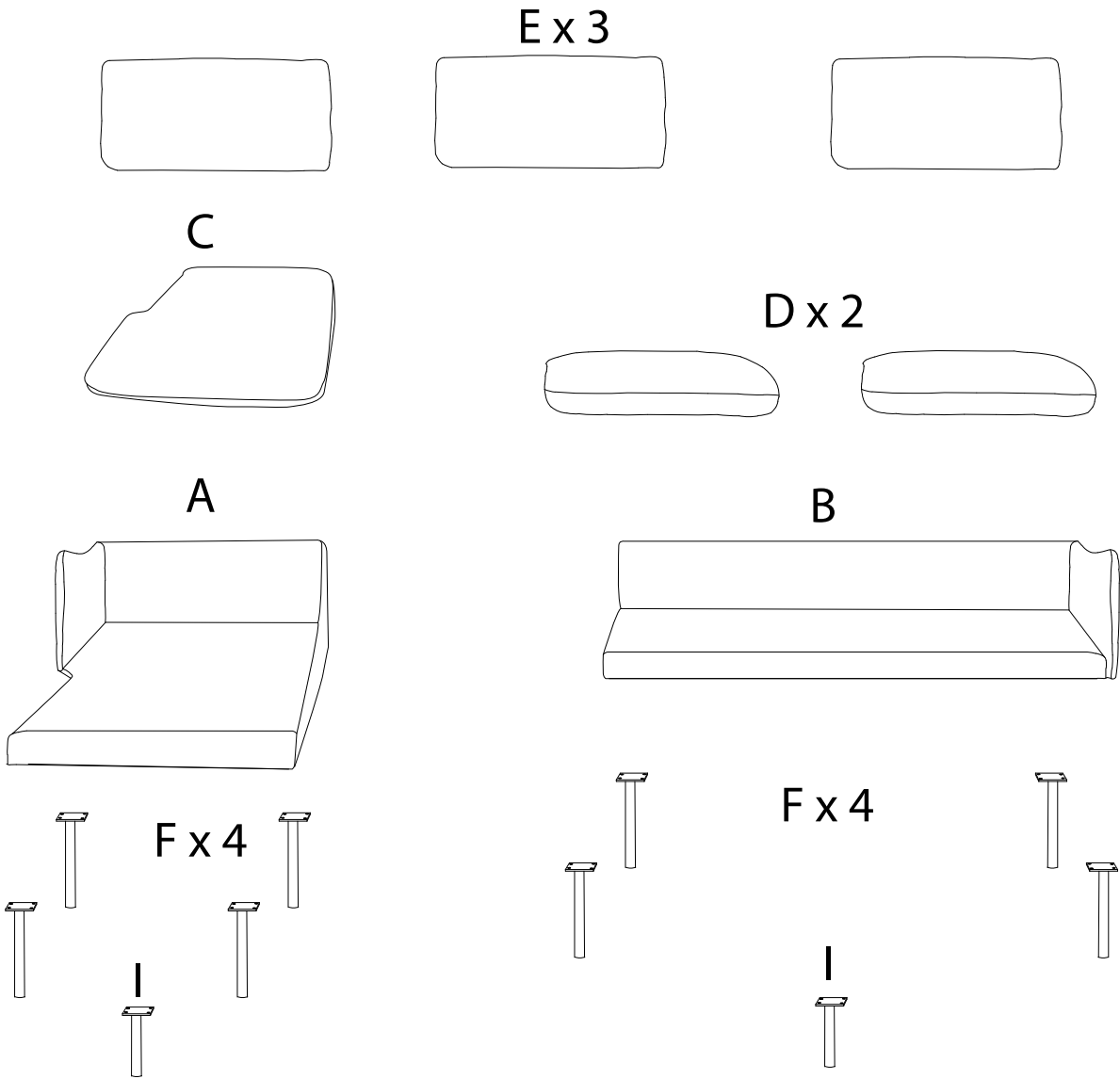

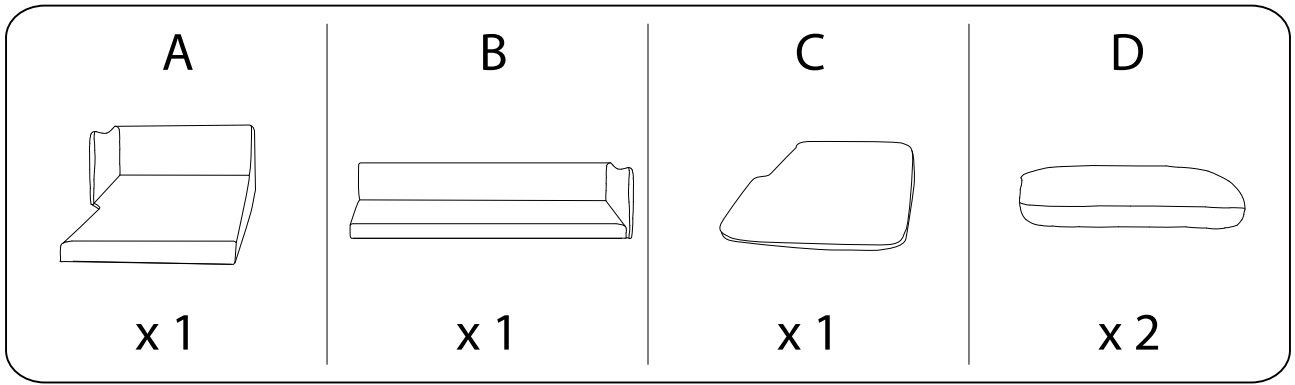
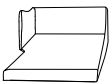
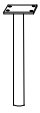

1

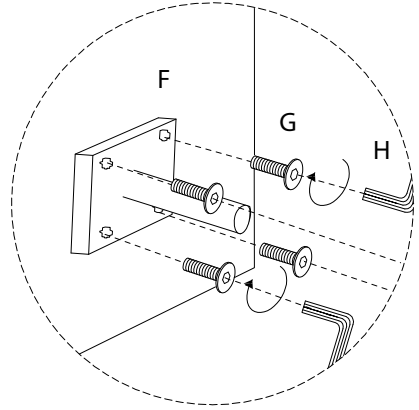
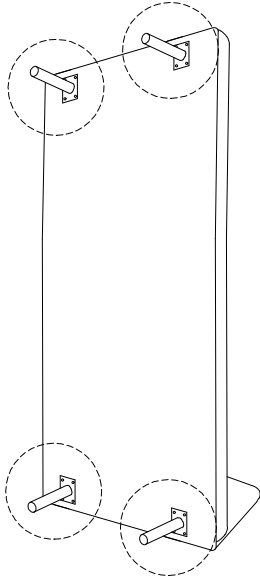
<p>A</p>  <p>x 1</p>	<p>F</p>  <p>x 4</p>	<p>G</p>  <p>M4 x 22</p> <p>x 16</p>	<p>H</p>  <p>x 1</p>
--	--	---	--



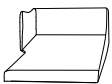

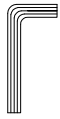

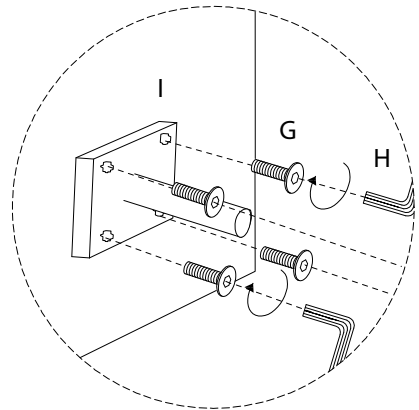
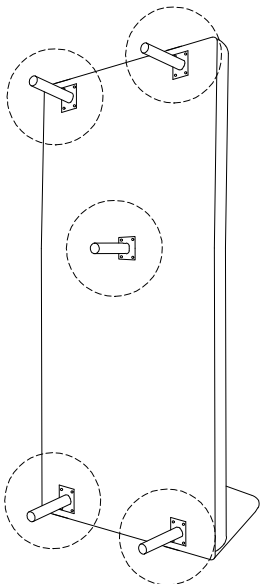
2

<p>B</p>  <p>x 1</p>	<p>I</p>  <p>x 1</p>	<p>G</p>  <p>M4 x 22</p> <p>x 4</p>	<p>H</p>  <p>x 1</p>
--	--	--	--

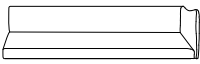

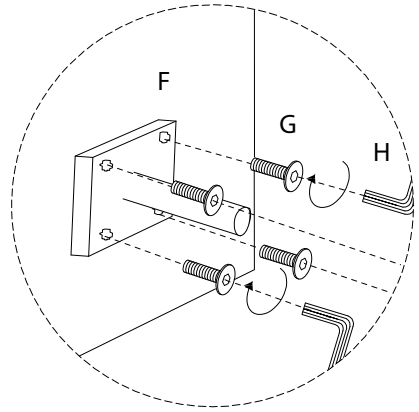
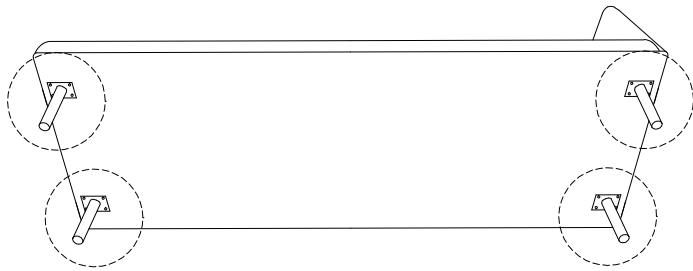

3

<p>A</p>  <p>x 1</p>	<p>F</p>  <p>x 5</p>	<p>G</p>  <p>M4 x 22</p> <p>x 16</p>	<p>H</p>  <p>x 1</p>
---	---	--	---

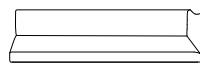

4

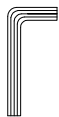
<p>B</p>  <p>x 1</p>	<p>I</p>  <p>x 5</p>	<p>G</p>  <p>M4 x 22</p> <p>x 4</p>	<p>H</p>  <p>x 1</p>
---	---	---	---

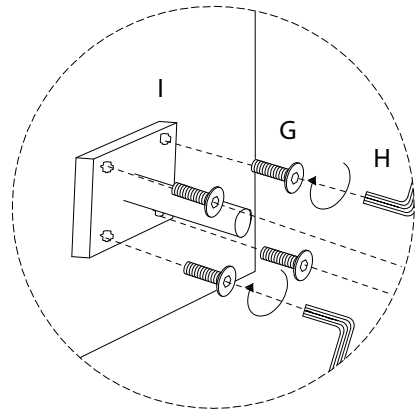
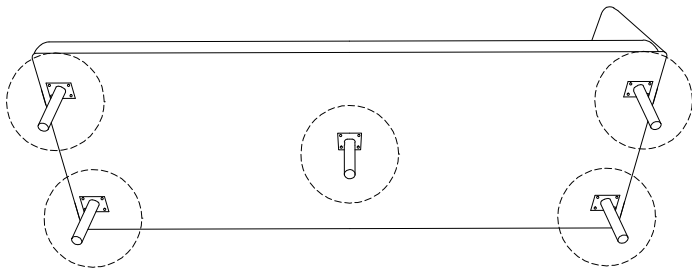

7

