

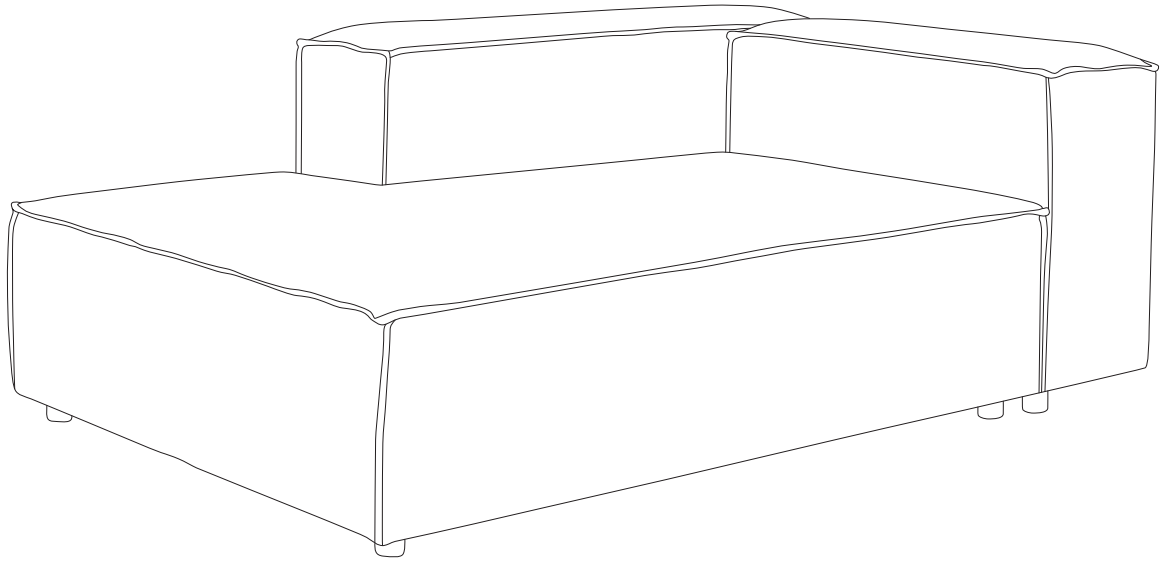

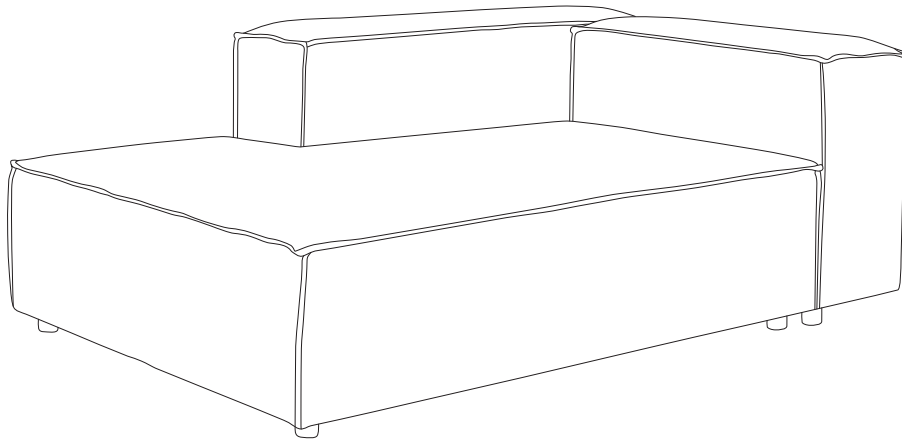

APRICA

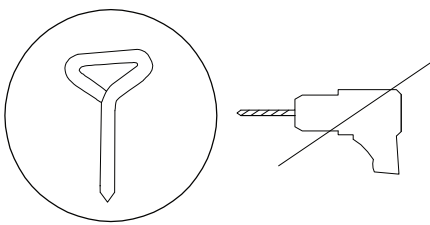



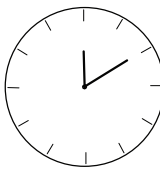
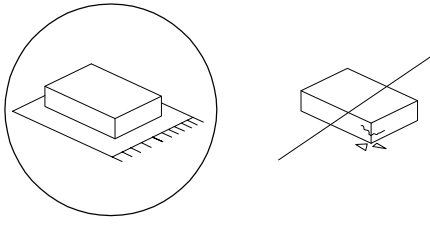

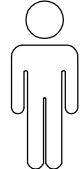

10'

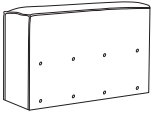
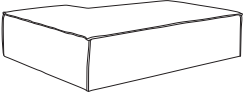
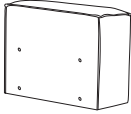
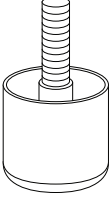
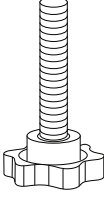
2

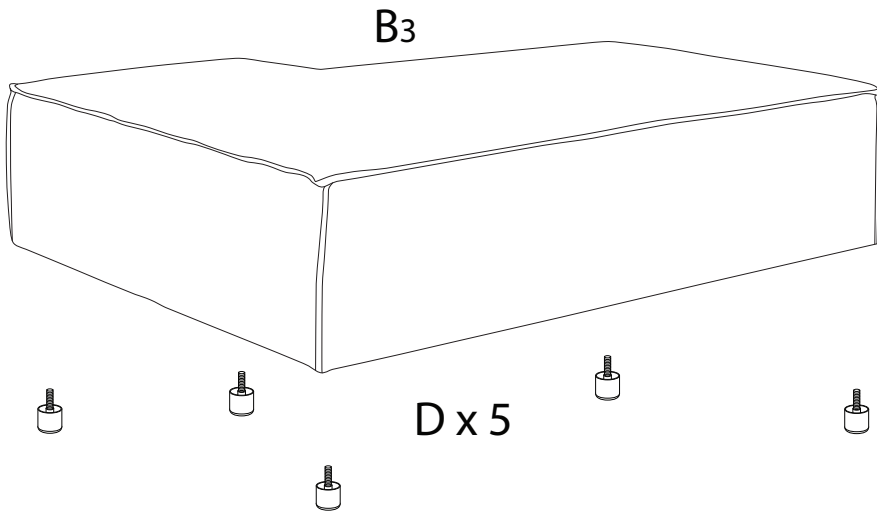
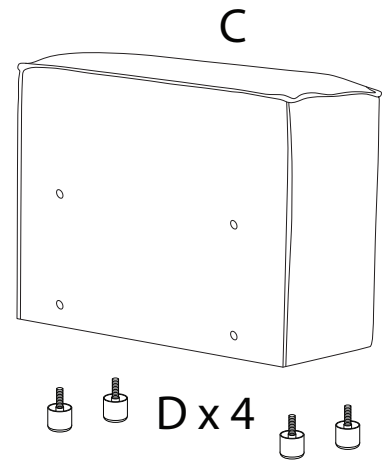
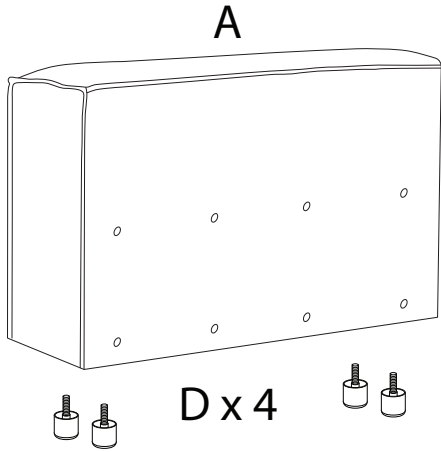
A	B₃	C	D	E
				
x 1	x 1	x 1	x 13	x 8

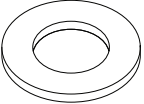
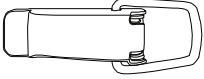
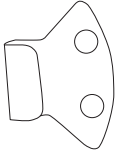

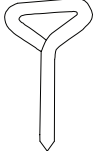
F	G₁	G₂	H	I
				
x 8	x 2	x 2	x 8	x 1

!

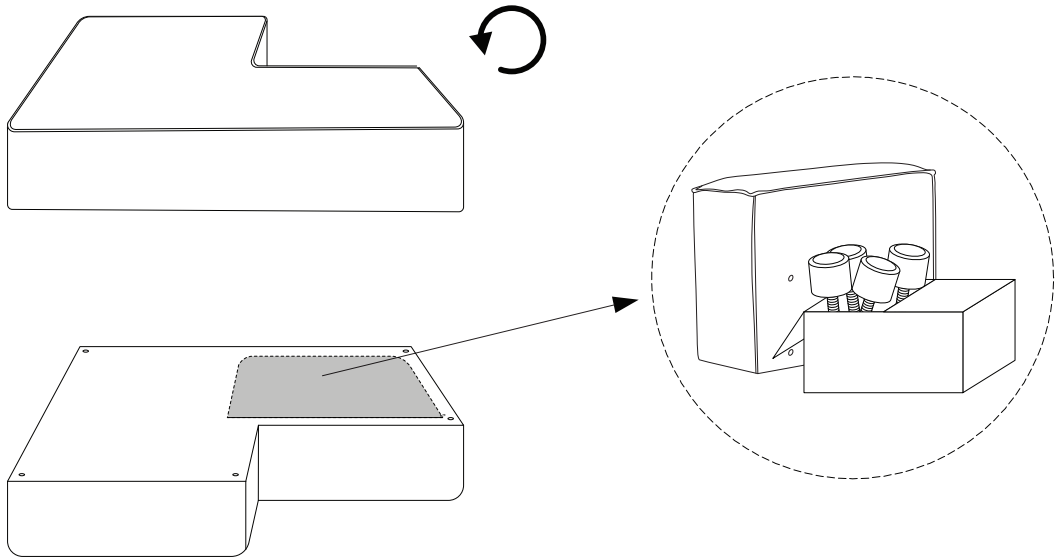

1

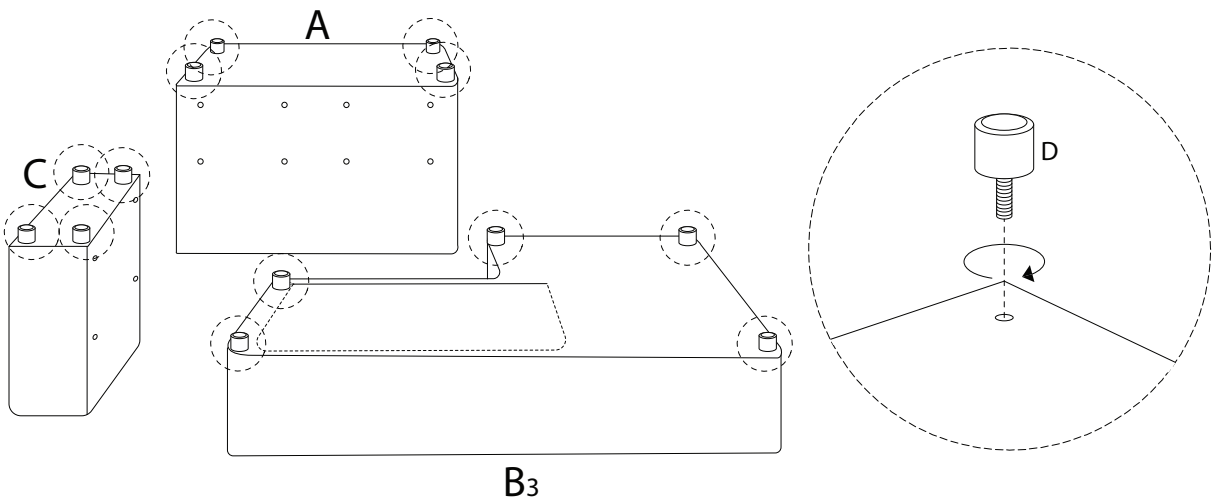
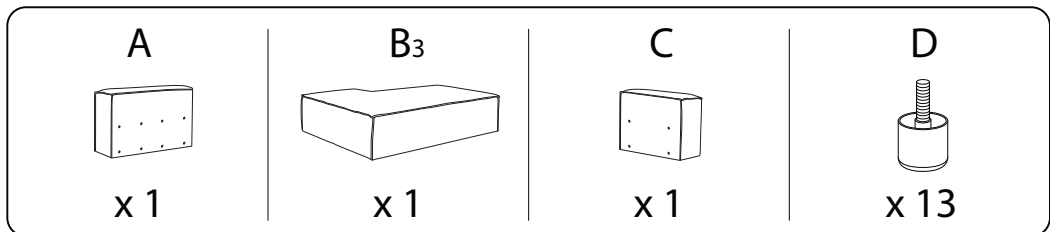

2

E



x 8

F



x 8

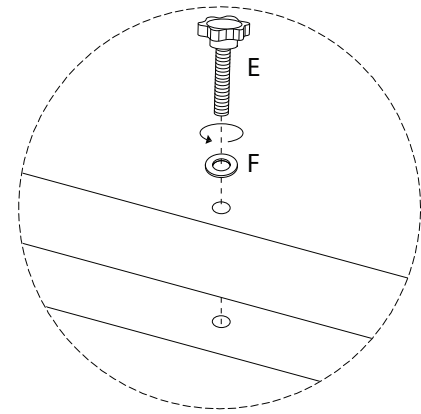
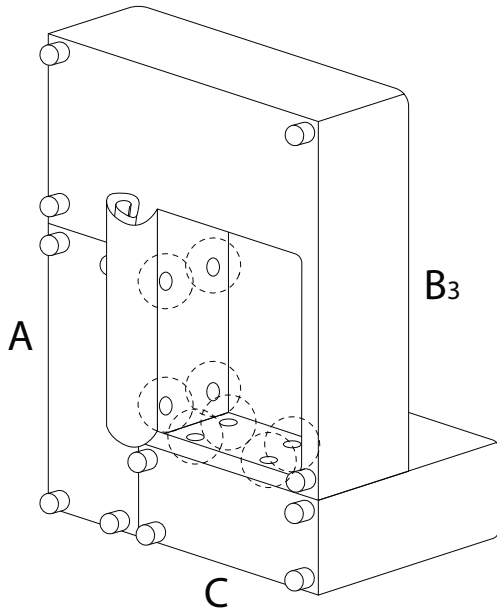

3

G₂

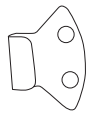

x 2

H

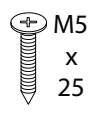

x 4

I

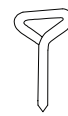

x 1

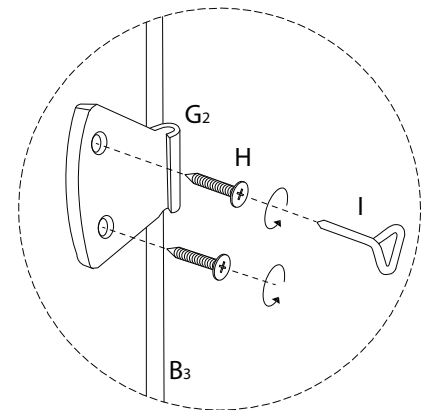
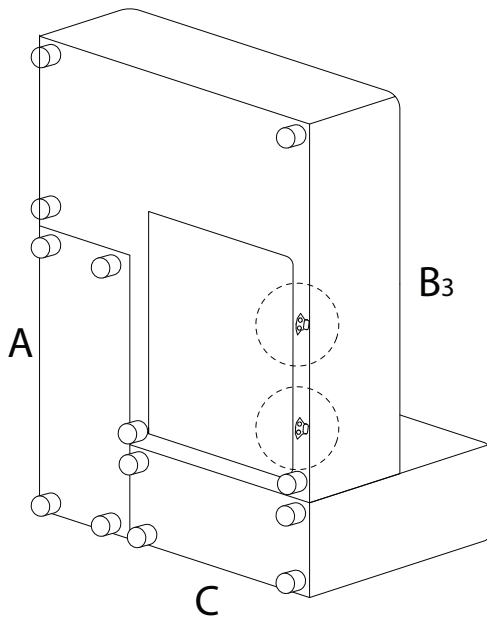

4

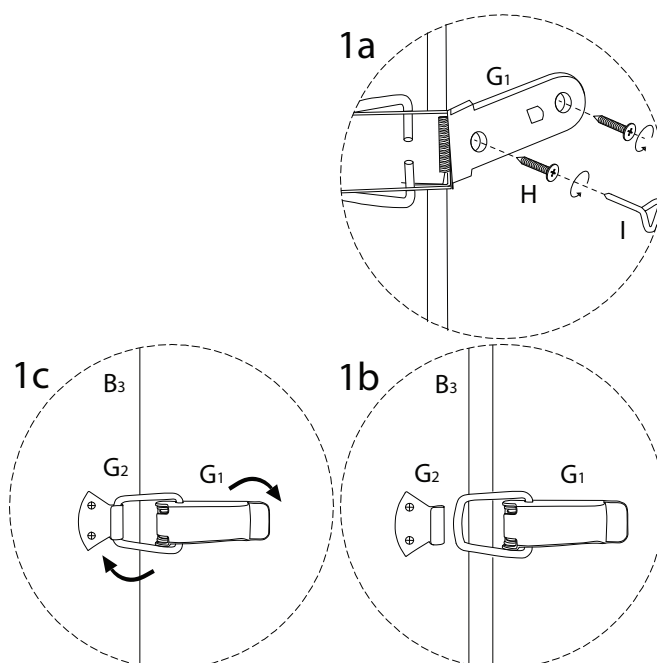
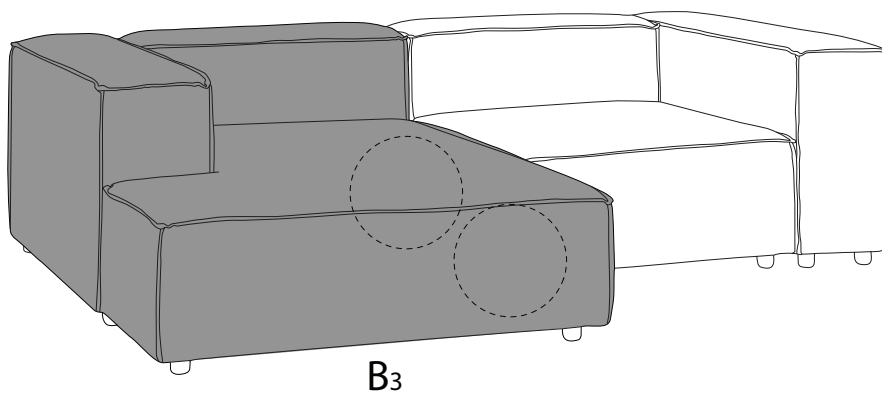
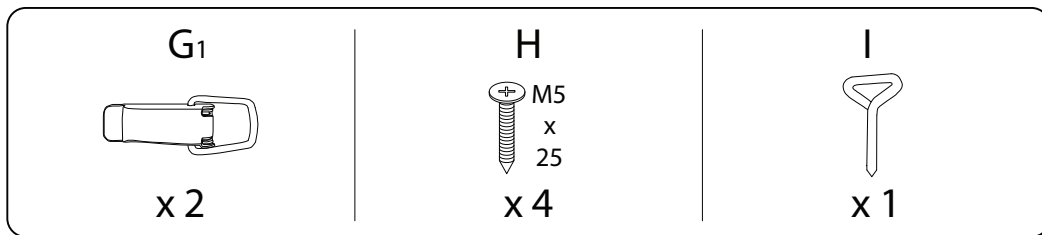

!

