

APITI

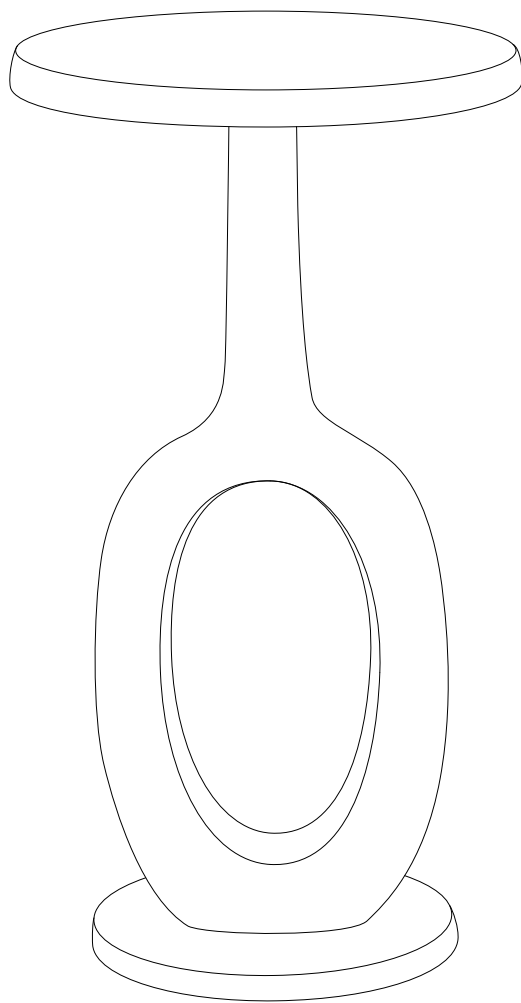

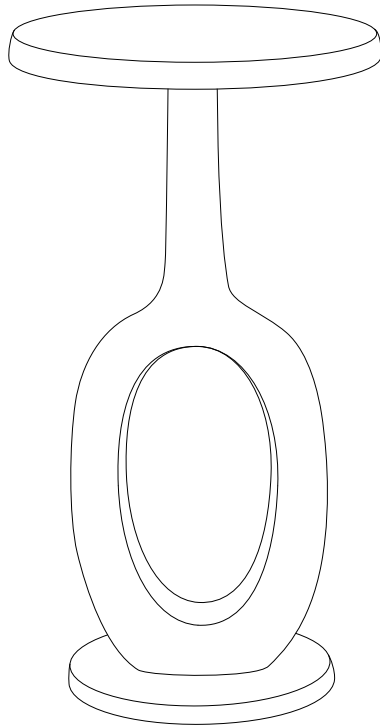
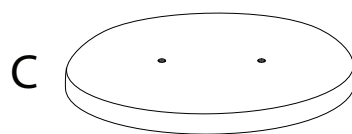
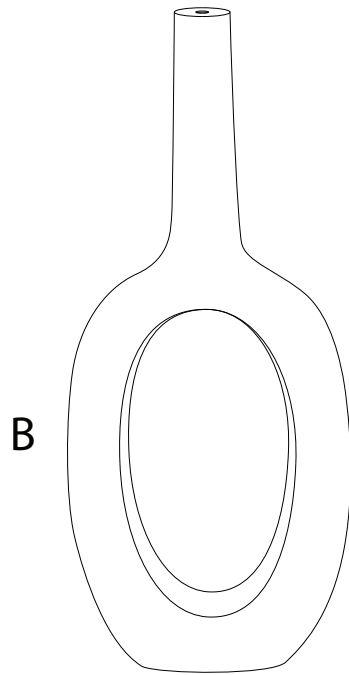
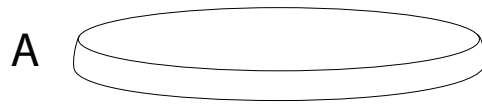

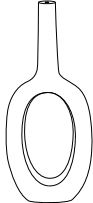





Diagram illustrating assembly steps and safety warnings:

- Top Section:** Shows an L-shaped metal bracket being attached to a surface. A power drill is shown with a diagonal line through it, indicating it should not be used. A warning triangle with an exclamation mark is positioned to the right. Below this is a clock icon and the text "10'".
- Bottom Section:** Shows a rectangular block being placed on a surface. A screwdriver is shown with a diagonal line through it, indicating it should not be used. A warning triangle with an exclamation mark is positioned to the right. Below this is a person icon and the text "1".



A	B	C	D	E
			 <p>M8 x 20</p>	
x 1	x 1	x 1	x 2	x 1

1

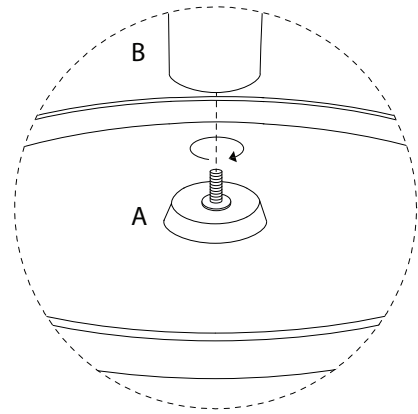
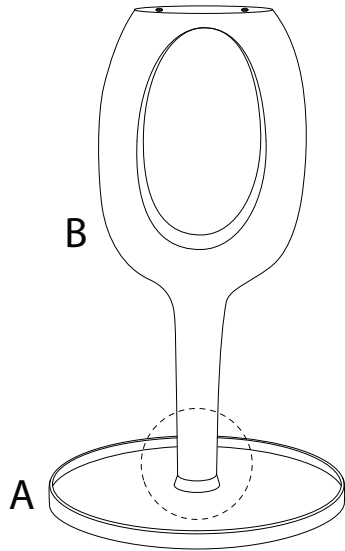
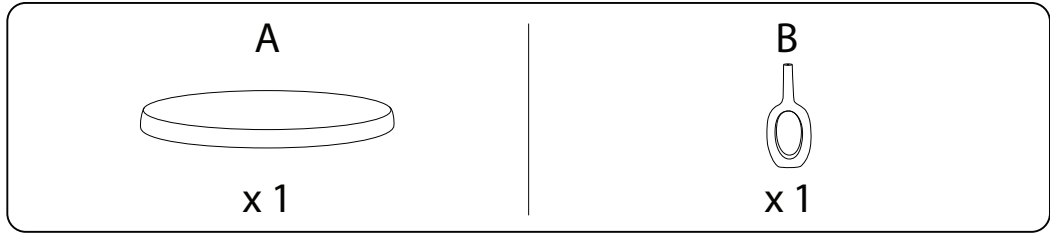

2

