

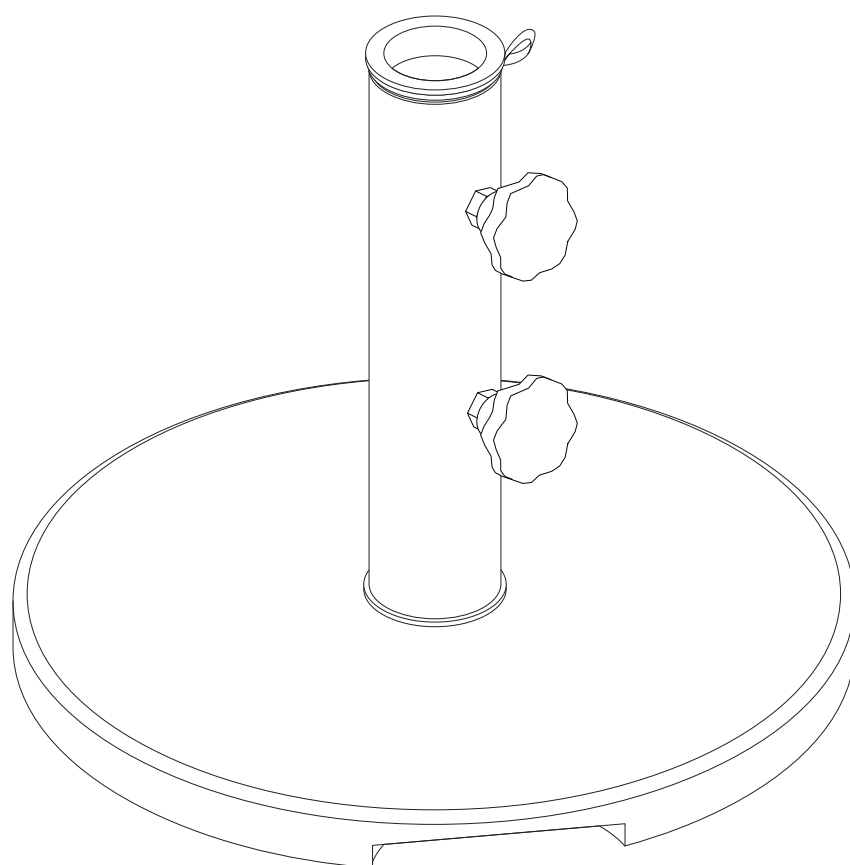

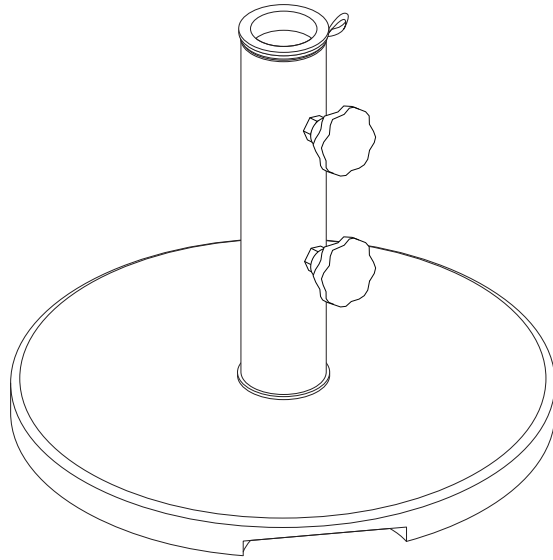

CEGGIA

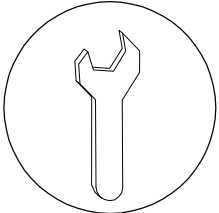

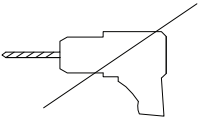

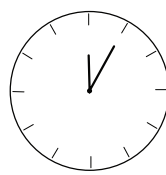
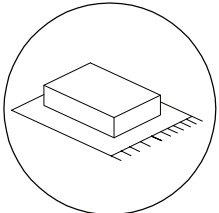
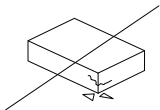
 		
 		<p>5'</p>  <p>1</p>

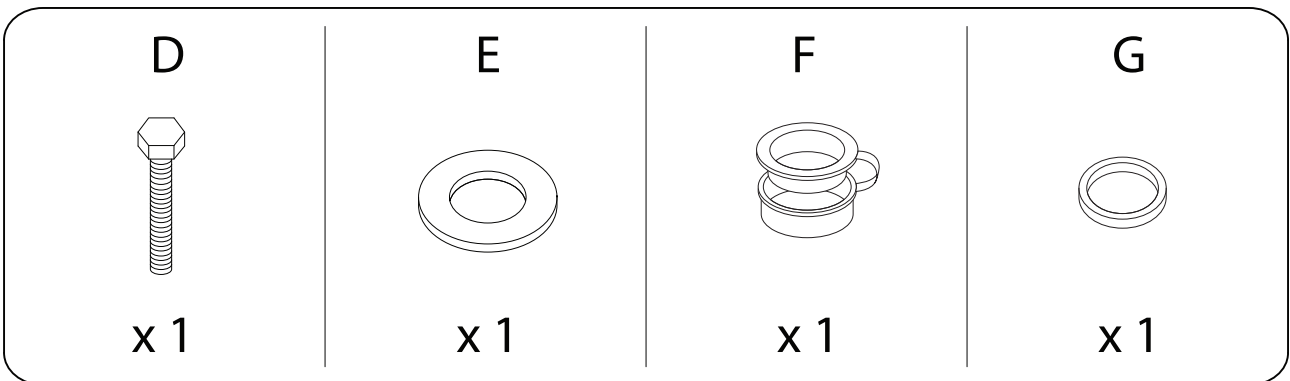
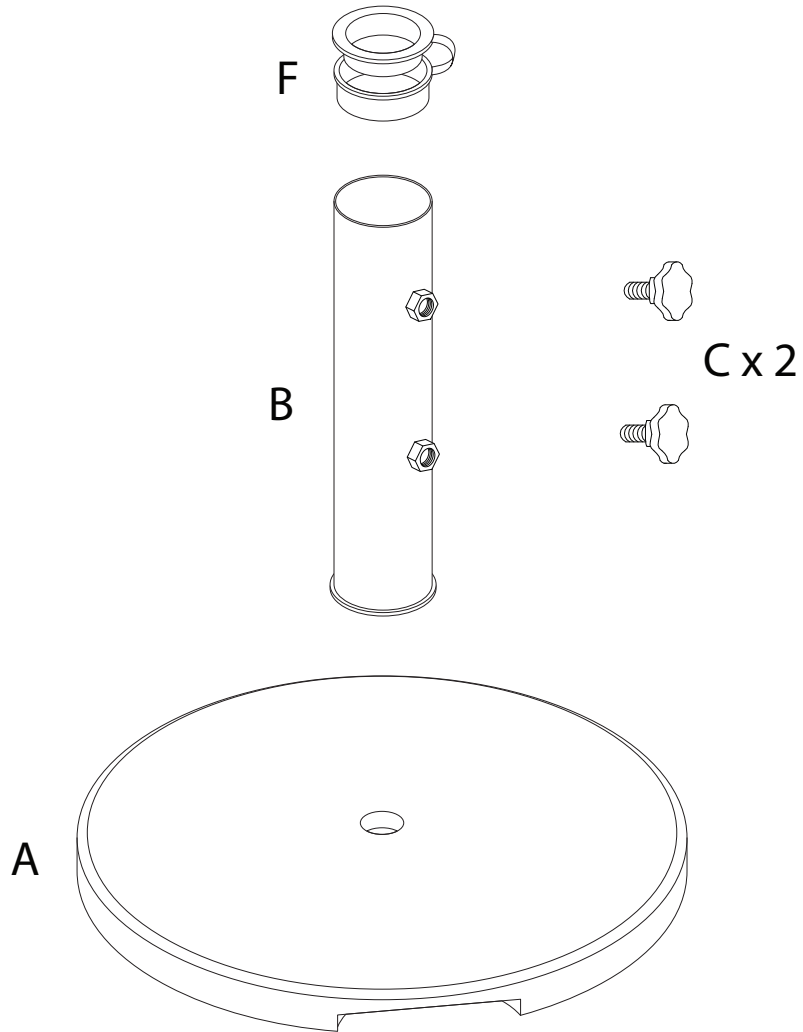
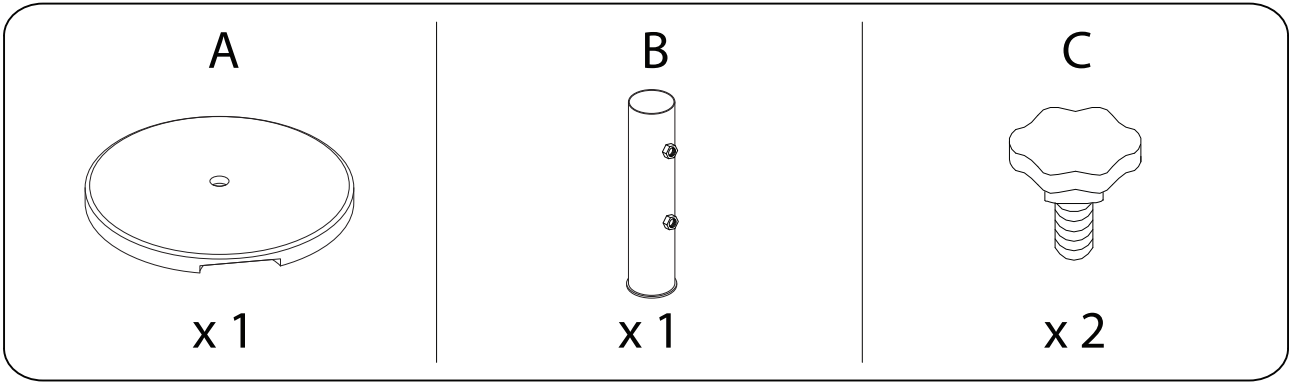

1

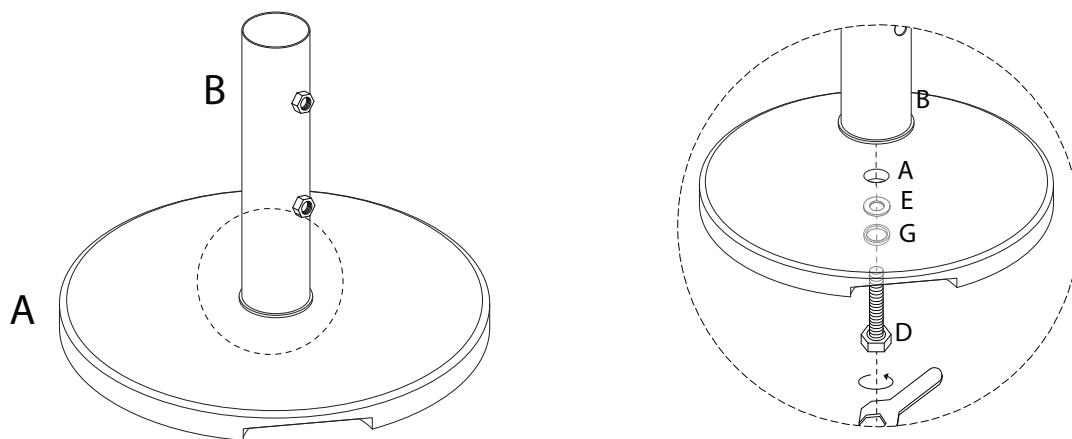
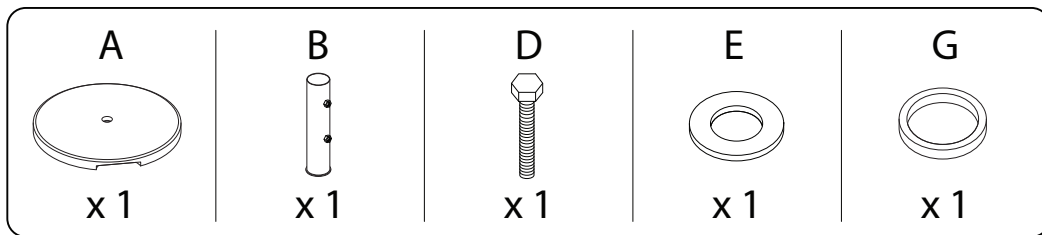

2

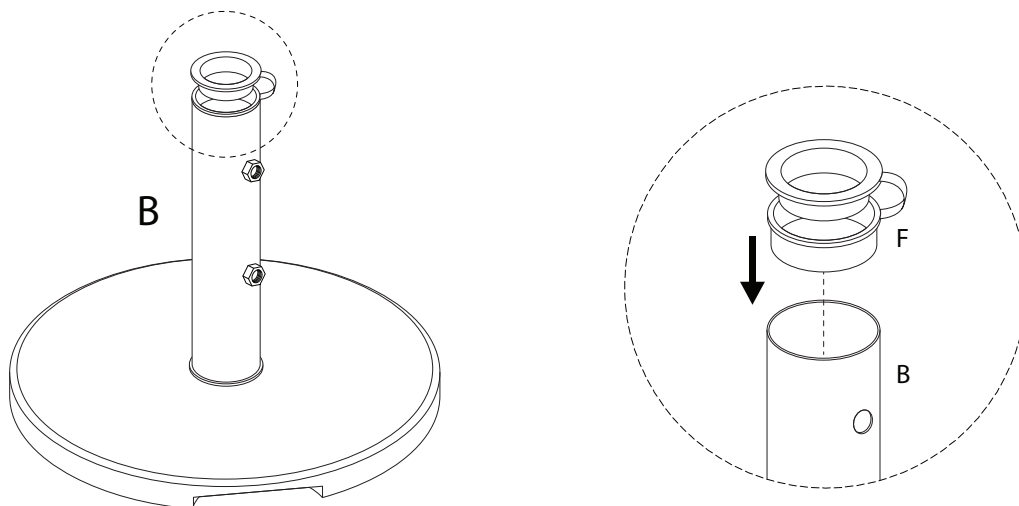
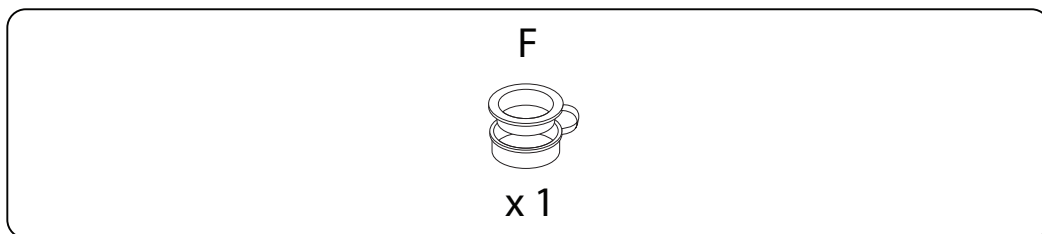

3

C



x2

