

A

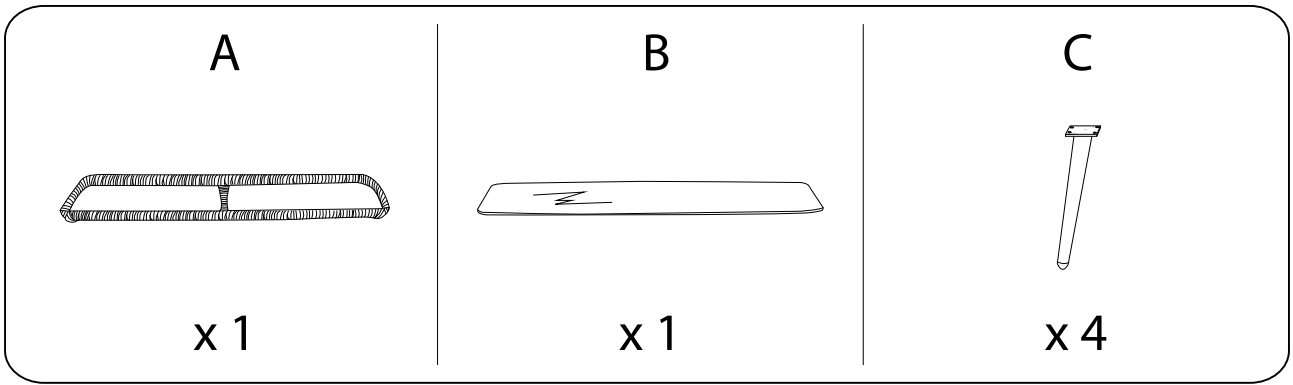

B



A

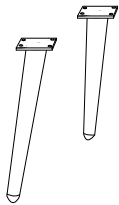
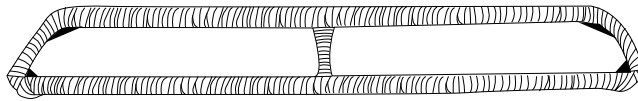

C x 4

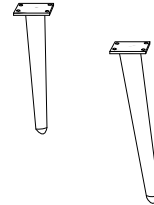

D

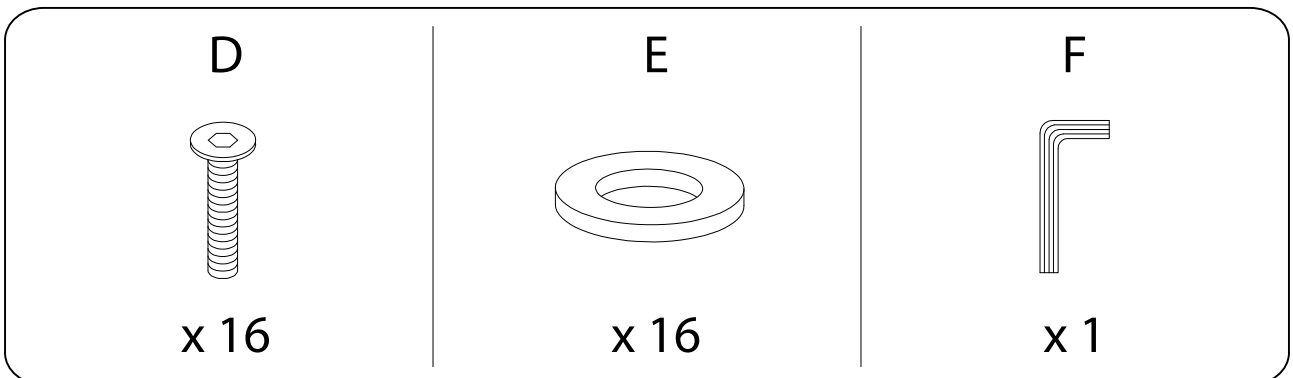

1

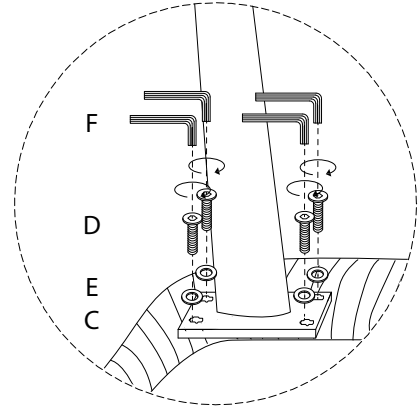
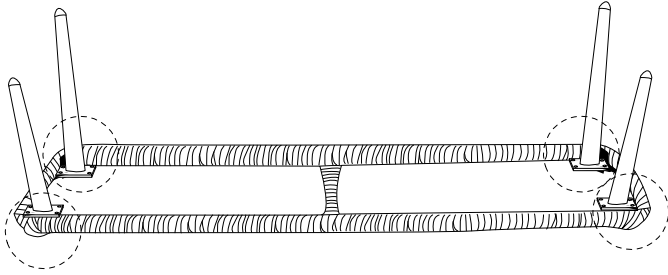
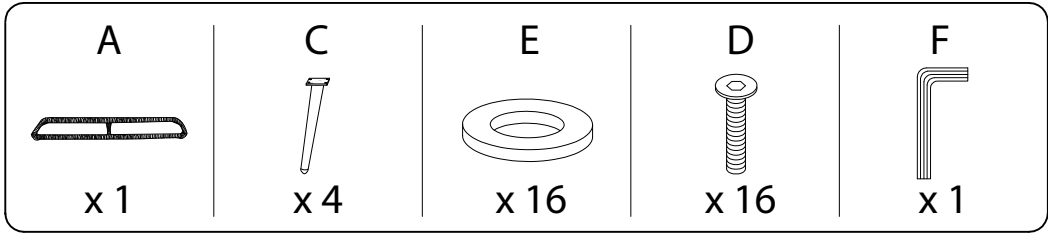

2

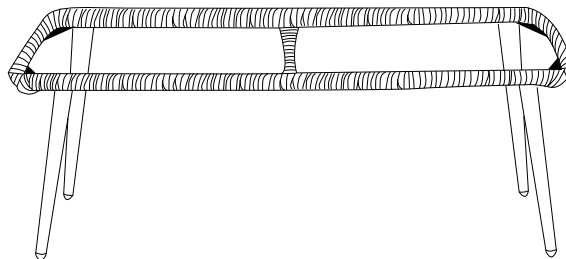
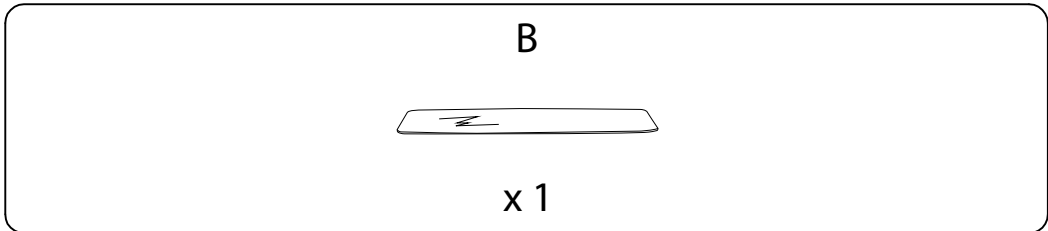

B

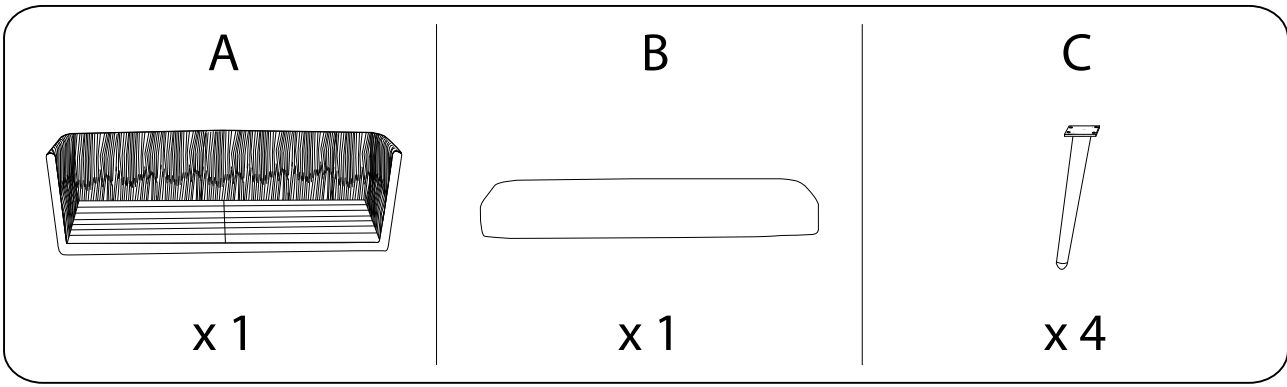

G

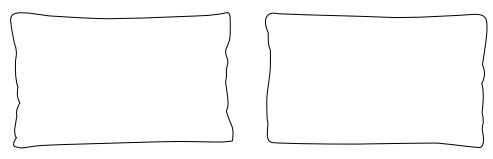

B



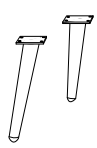
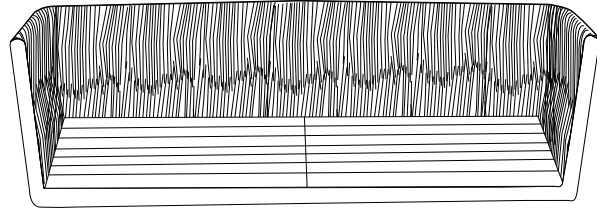

A

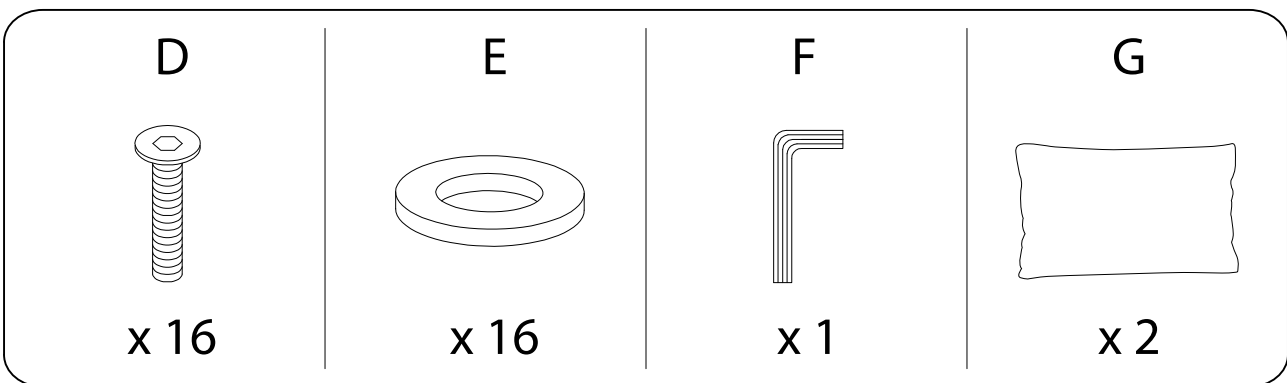

C x 4

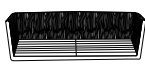

1

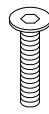
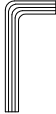
<b>A</b>  x 1	<b>C</b>  x 4	<b>E</b>  x 16	<b>D</b>  x 16	<b>F</b>  x 1
--	--	---	---	--

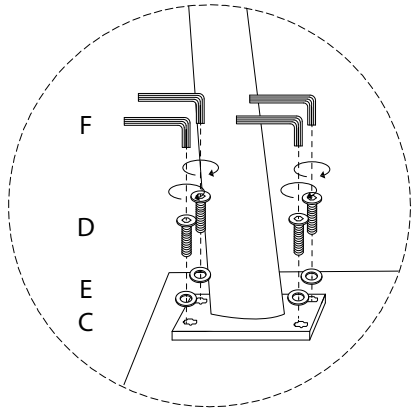
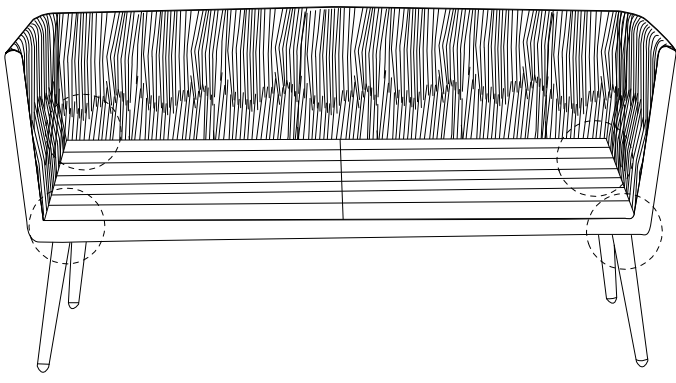

2

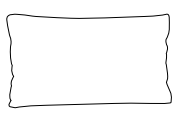
<b>B</b>  x 1	<b>G</b>  x 2
--	--

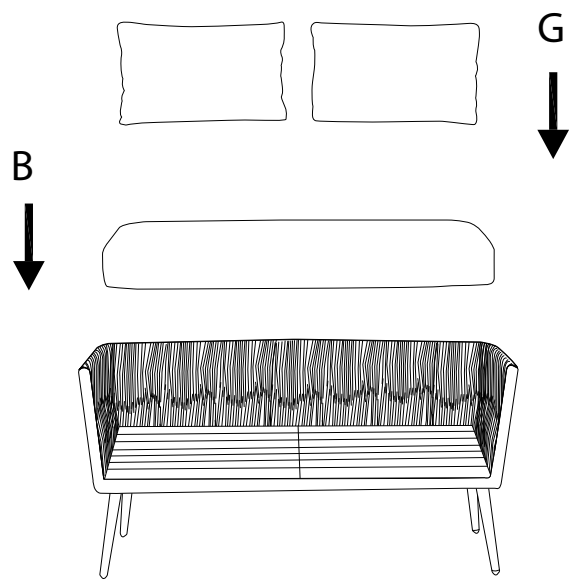

C

A

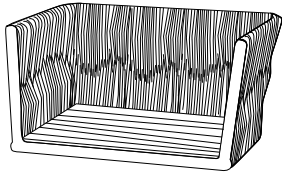

x 1

B



x 1

C



x 4

G

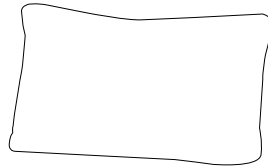

B



A

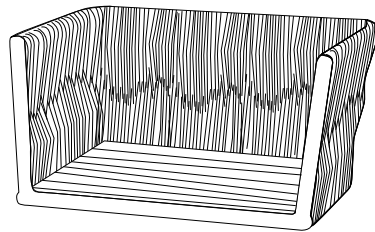

C x 4

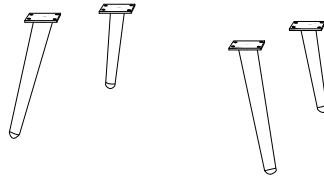

D

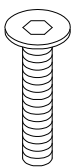

x 16

E

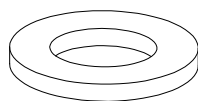

x 16

F

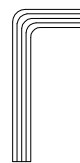

x 1

G

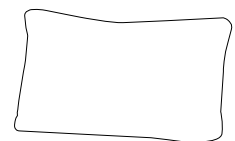

x 1

1

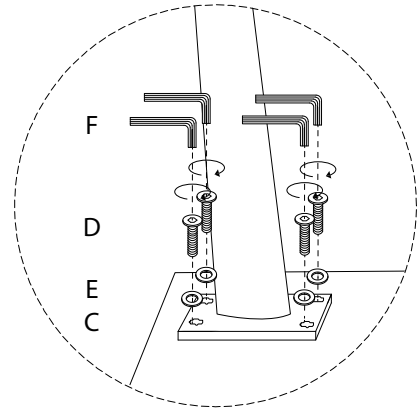
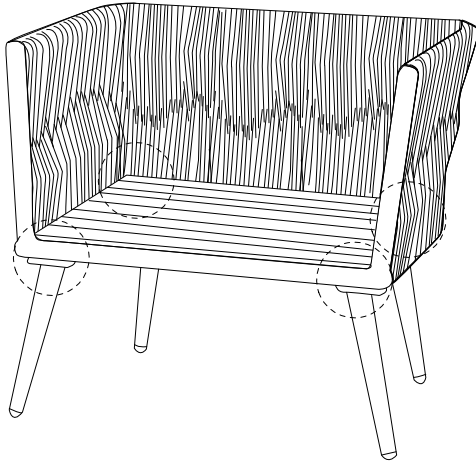
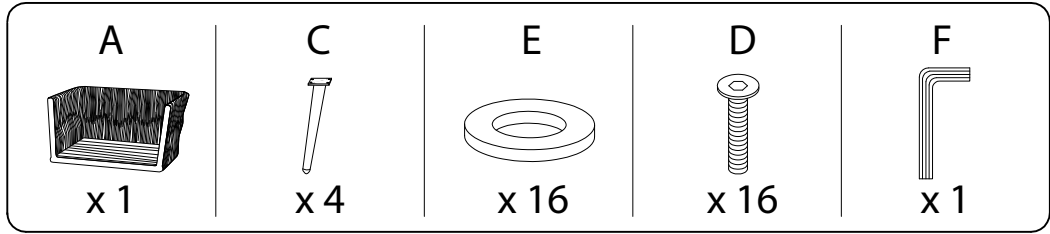

2

