

LOEN

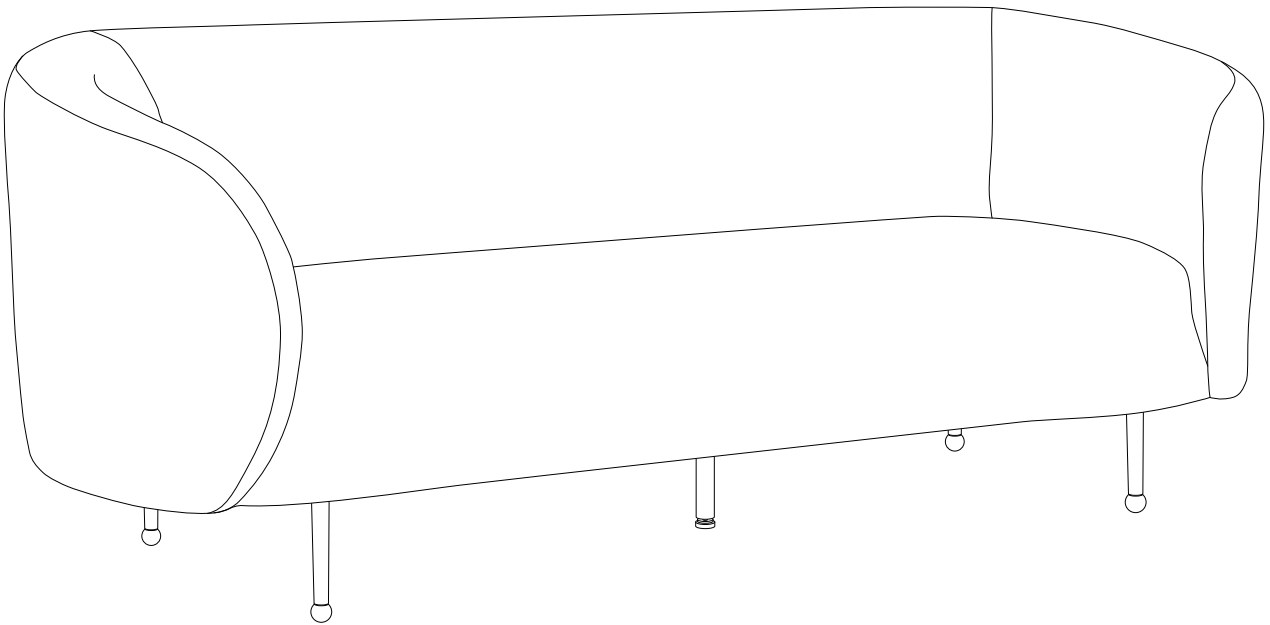

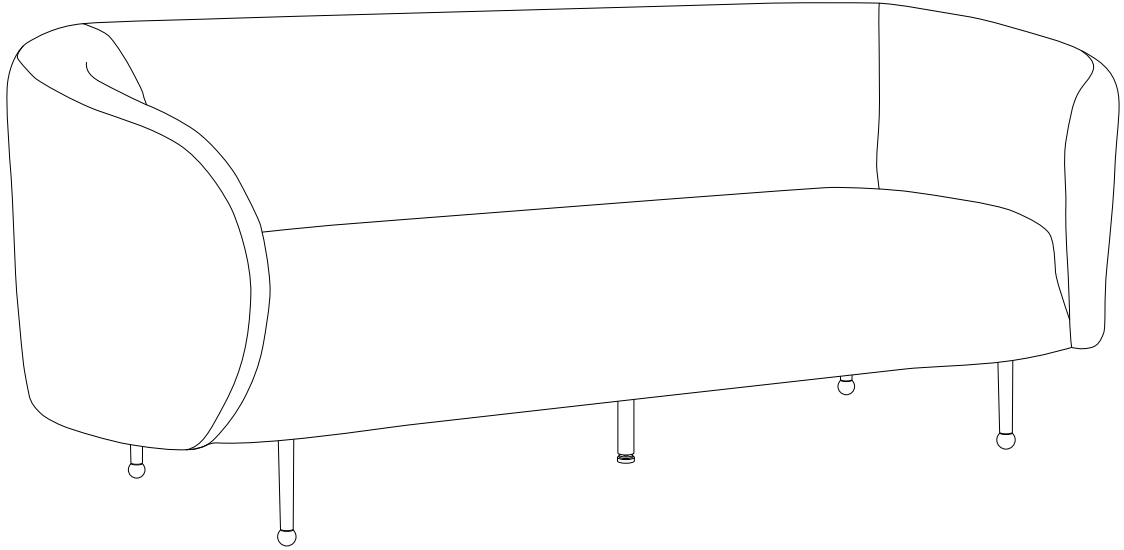

An icon showing an L-shaped metal bracket inside a circle, next to a power drill with a diagonal line through it, indicating that a power drill should not be used for this step.	A warning triangle icon with an exclamation mark inside.	A clock icon representing a time requirement.
<p>20'</p>		
An icon showing a rectangular block on a mat inside a circle, next to a similar block on a mat with a diagonal line through it, indicating that the block should not be placed on a mat.	A warning triangle icon with an exclamation mark inside.	An icon of a person, representing the number of people required for the step.
<p>2</p>		

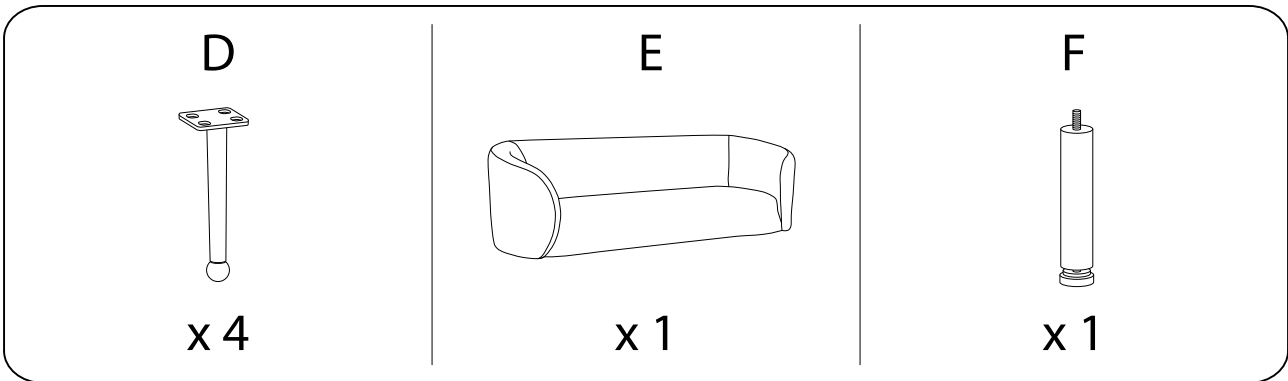
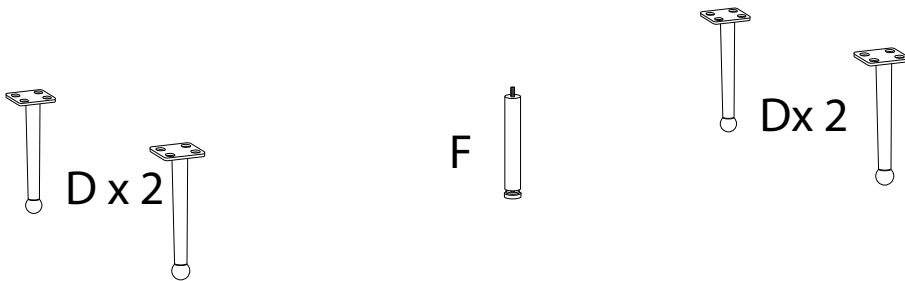
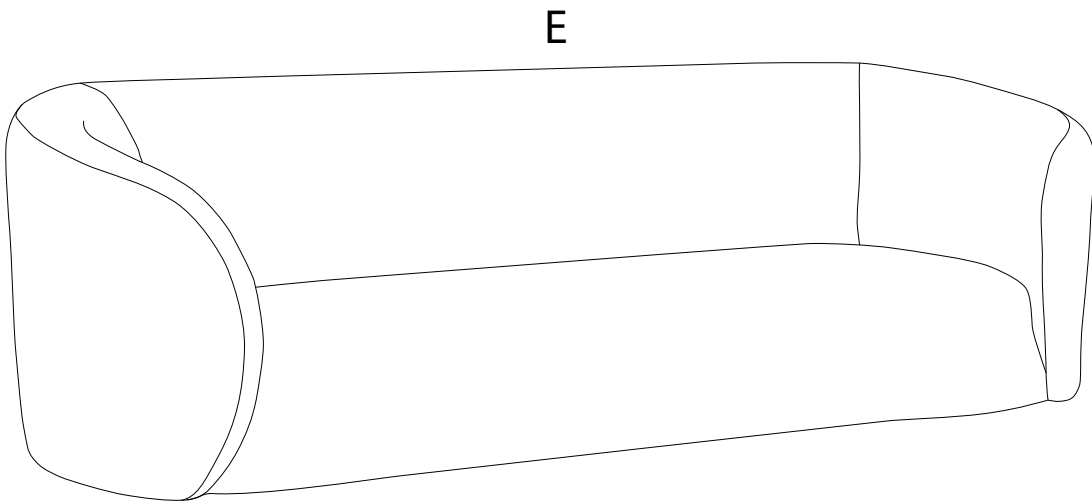
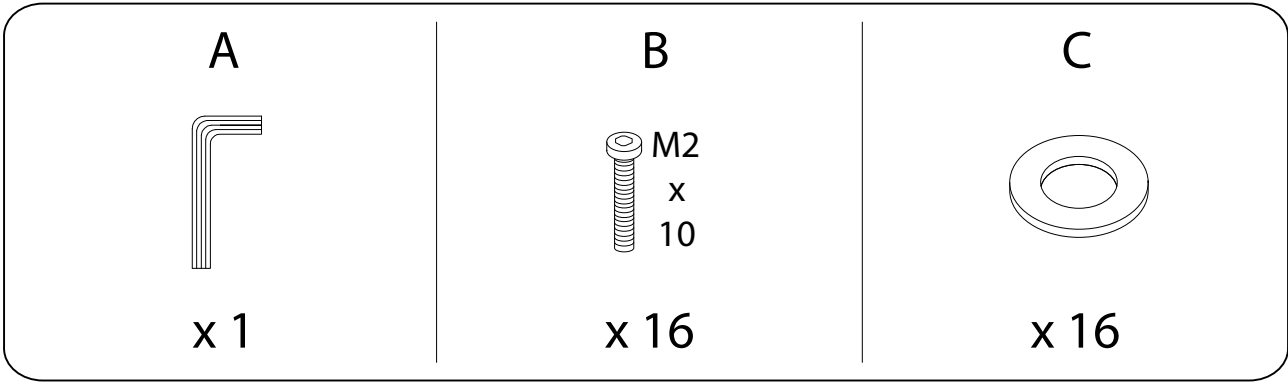

!

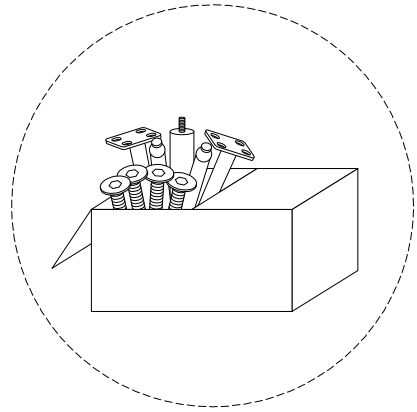
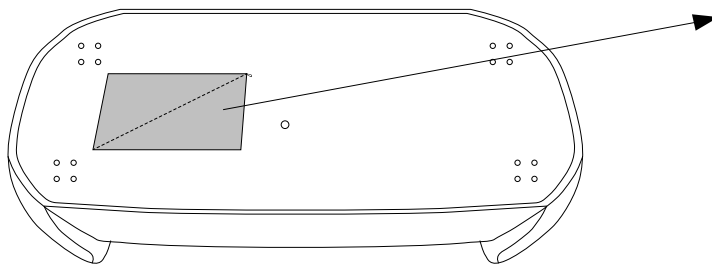
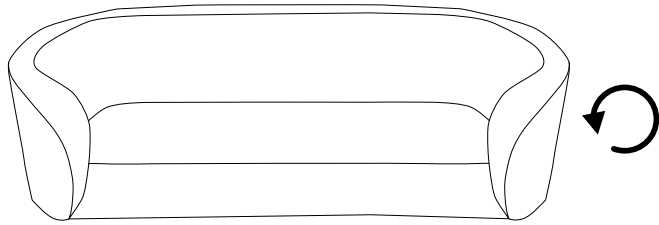

1

A

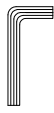

x 1

B

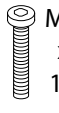

x 16

C

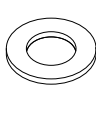

x 16

D



x 1

E

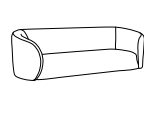

x 1

F



x 1

