

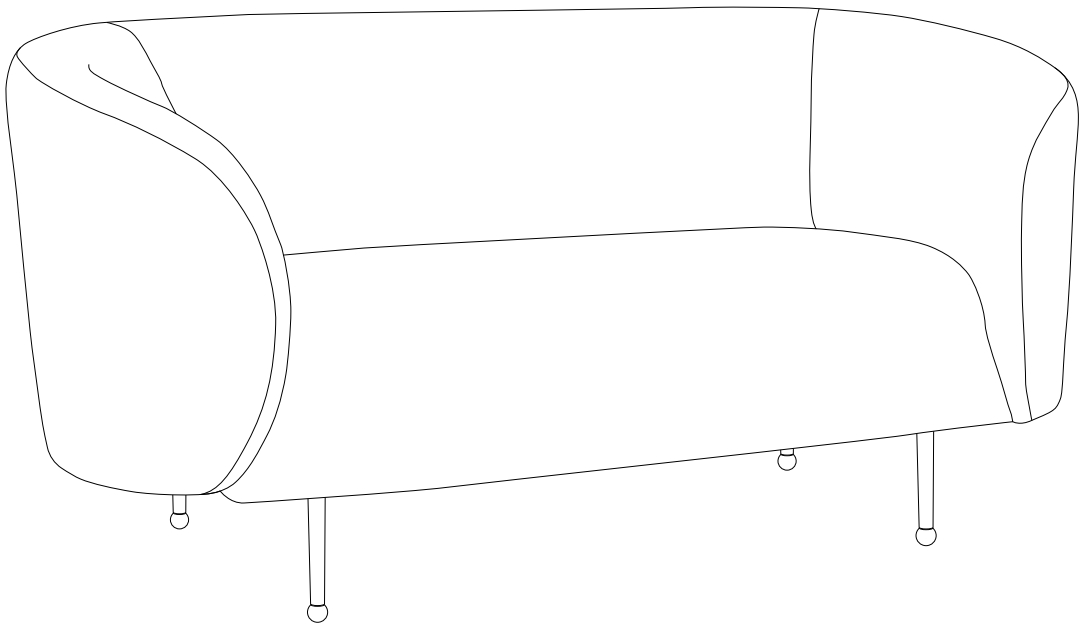

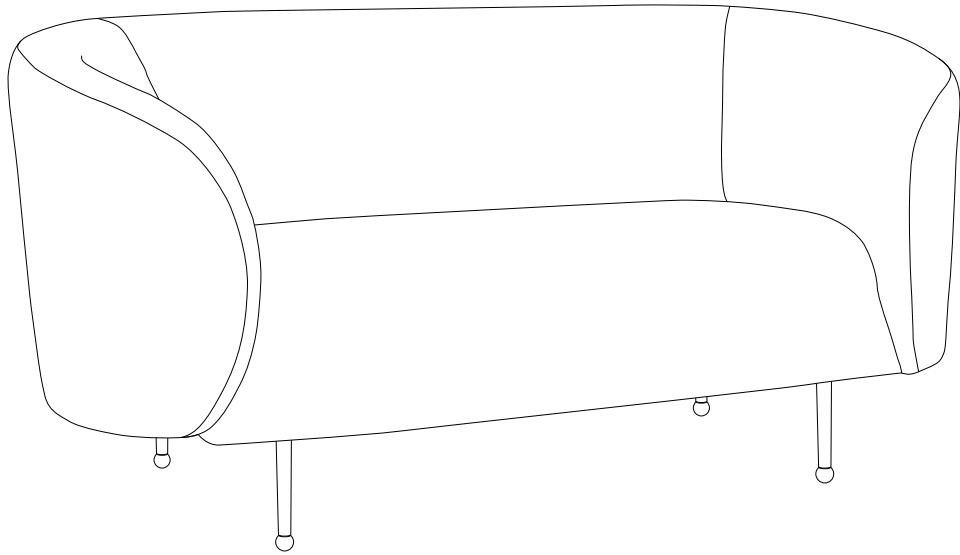

# LOEN

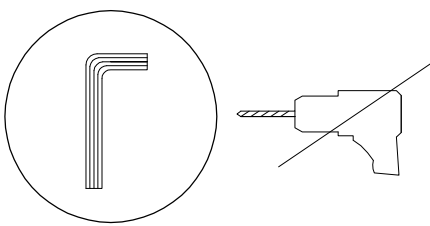

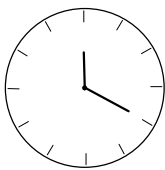
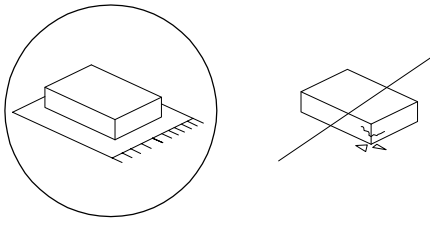

		
		<p>20'</p>
		
		<p>2</p>

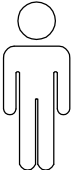
E

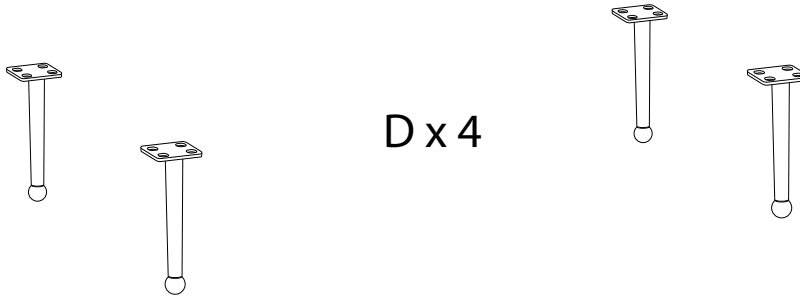
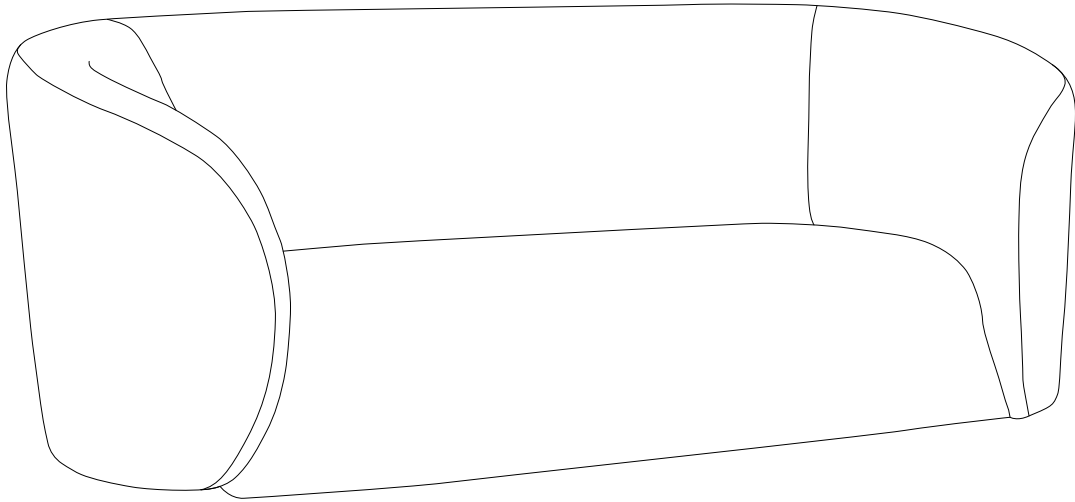

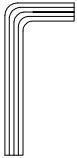
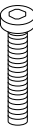
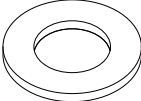
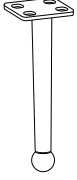
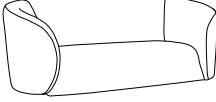
A	B	C	D	E
	 M2 x 10			
x 1	x 16	x 16	x 4	x 1

!

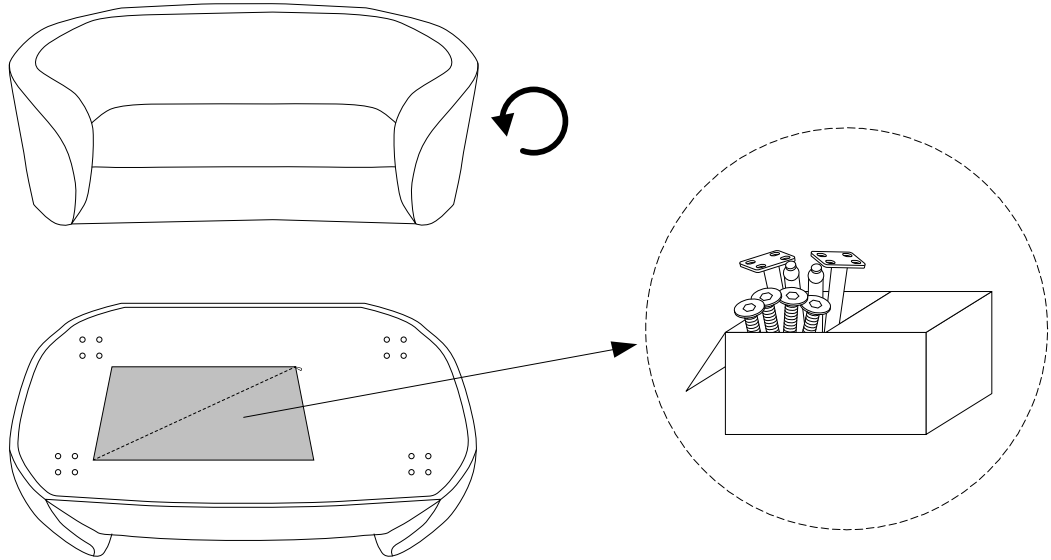

1

