

VALCANETTO

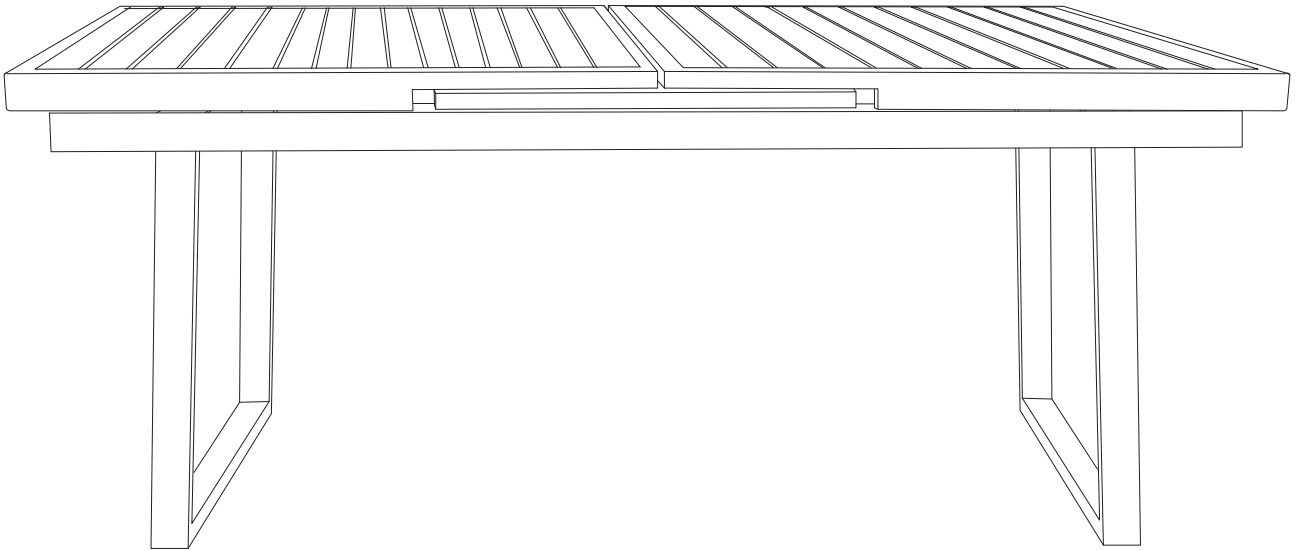

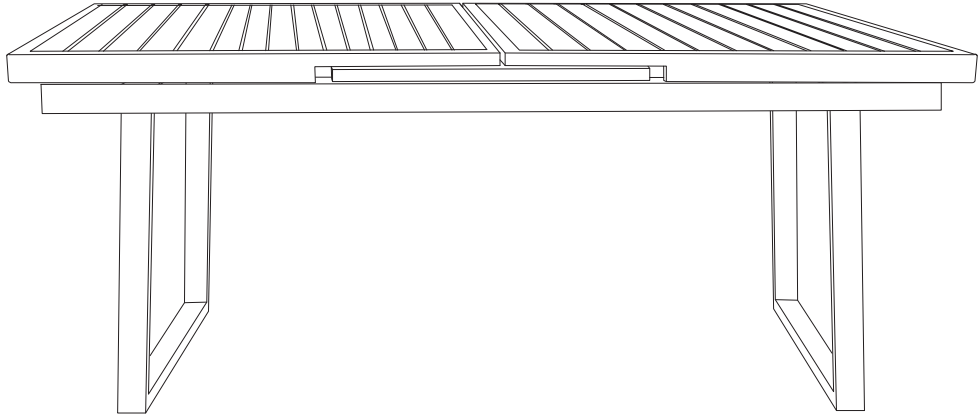
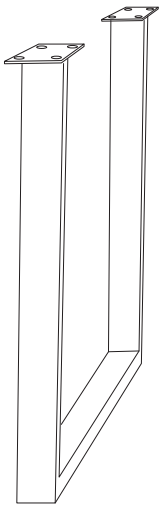
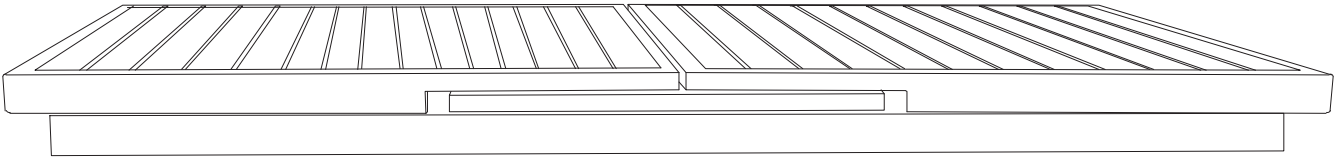

Diagram illustrating assembly steps and safety warnings:



- Step 1:** Shows an L-shaped metal bracket and a power drill with a slash through it, indicating that a power drill should not be used. A warning triangle with an exclamation mark is positioned to the right.
- Step 2:** Shows a rectangular block being placed on a surface and another block being secured with a screw. A warning triangle with an exclamation mark is positioned to the right.
- Time:** A clock icon is shown with the number **10'** below it, indicating a 10-minute assembly time.
- Personnel:** A person icon is shown with the number **2** below it, indicating that two people are required for assembly.

A



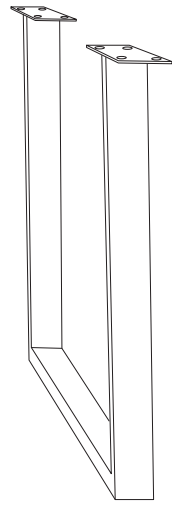

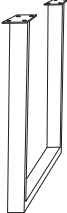
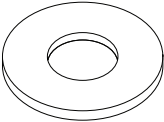
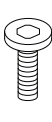
B x 2

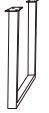

A	B	C	D	E
			 M6 x 16	
x 1	x 2	x 16	x 16	x 1

1

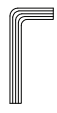
A  x 1	B  x 2	C  x 16	D  M6 x 16 x 16	E  x 1
--	--	---	--	--

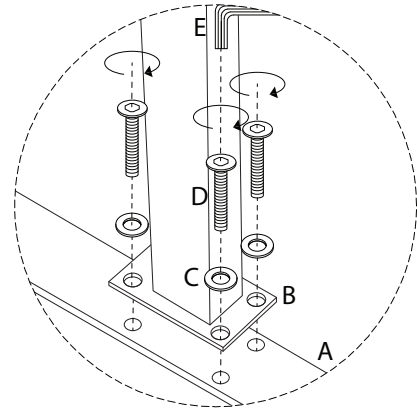
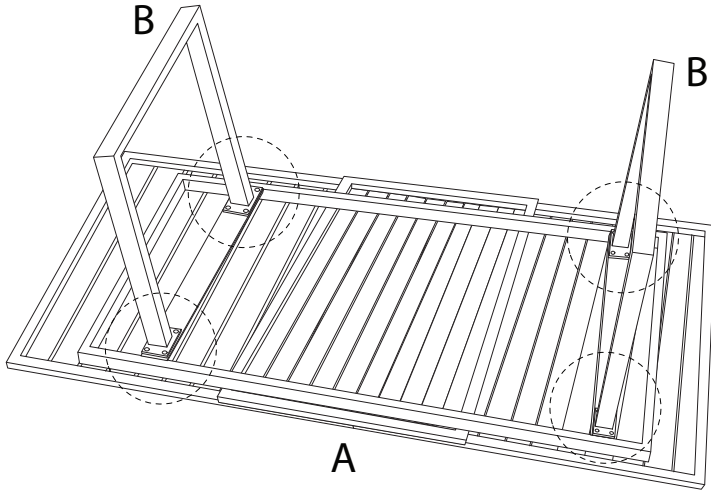

!

