

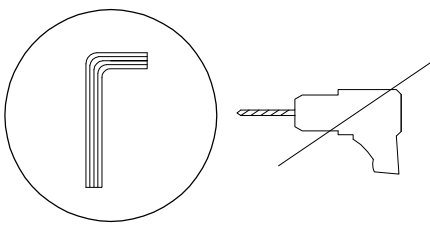

|   |   |   |
|---|---|---|
|  |  |  |
|   |   | <b>20'</b>  |
|  |  |  |
|   |   | <b>1</b>  |







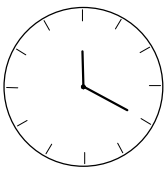
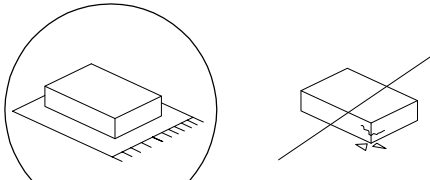
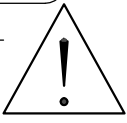
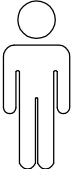
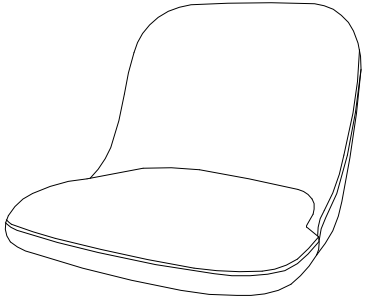
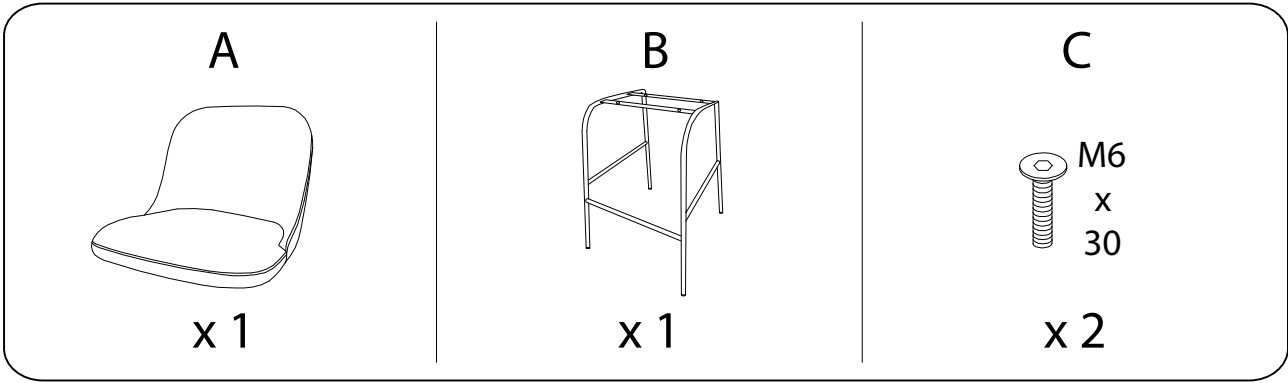
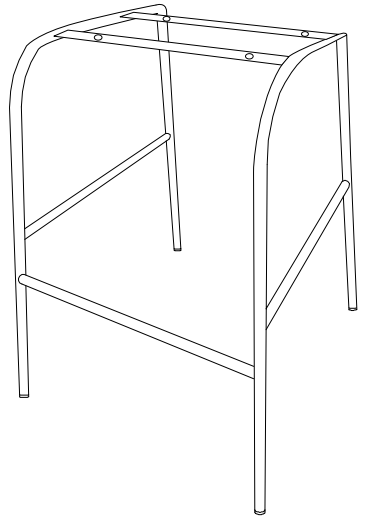

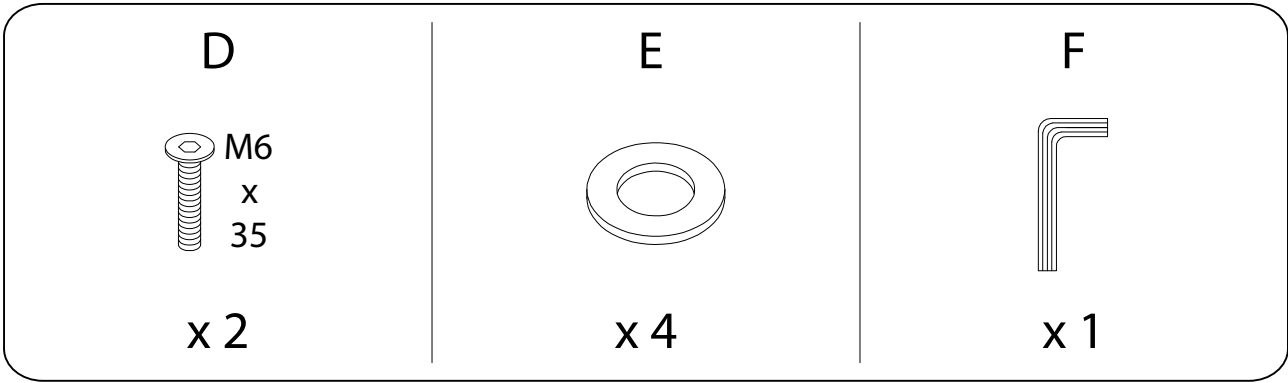
A



B

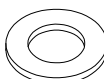

1

|  |  |   |   |  |  |
|--|--|---|---|--|--|
| <b>A</b><br><br>x 1 | <b>B</b><br><br>x 1 | <b>C</b><br><br>M6<br>x<br>30<br>x 2 | <b>D</b><br><br>M6<br>x<br>35<br>x 2 | <b>E</b><br><br>x 4 | <b>F</b><br><br>x 1 |
|--|--|---|---|--|--|

