

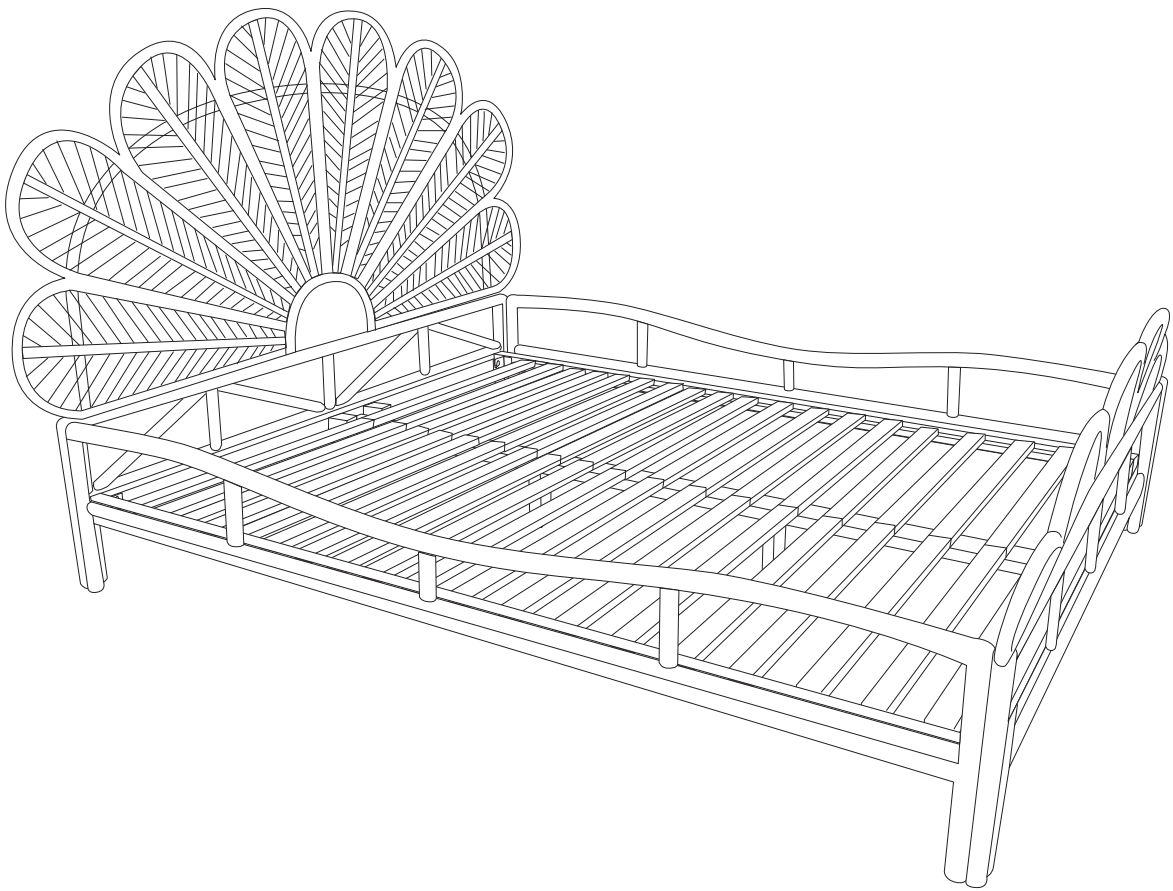

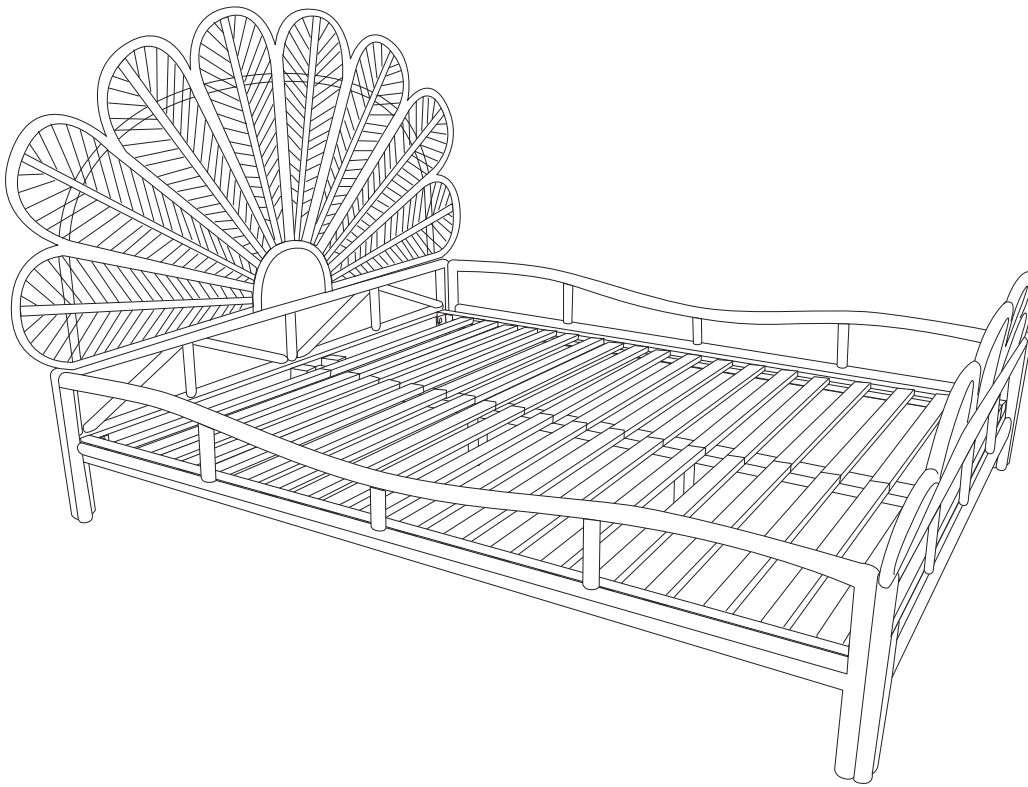



FLORENTINE



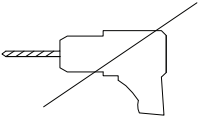

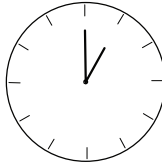
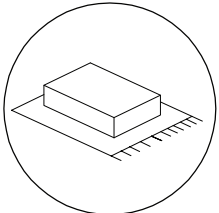
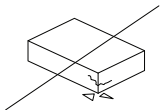
 		
		60'
 		
		2

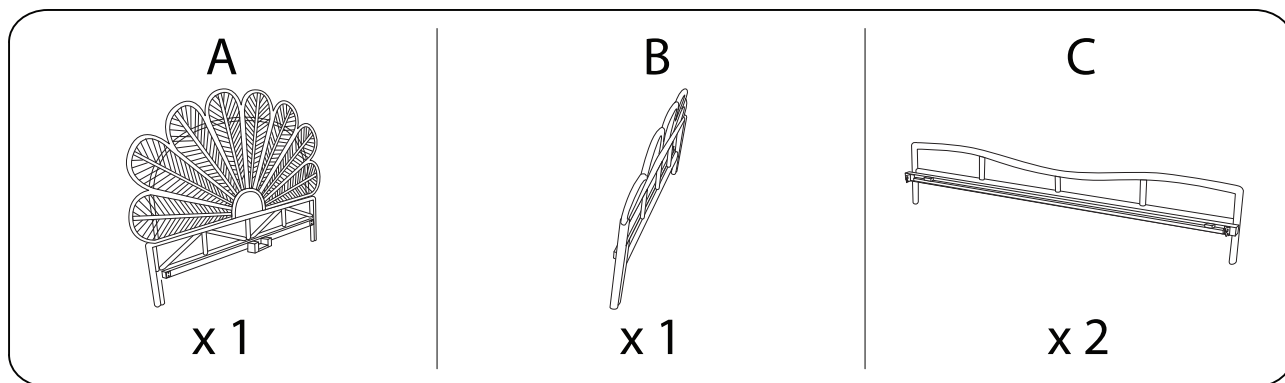
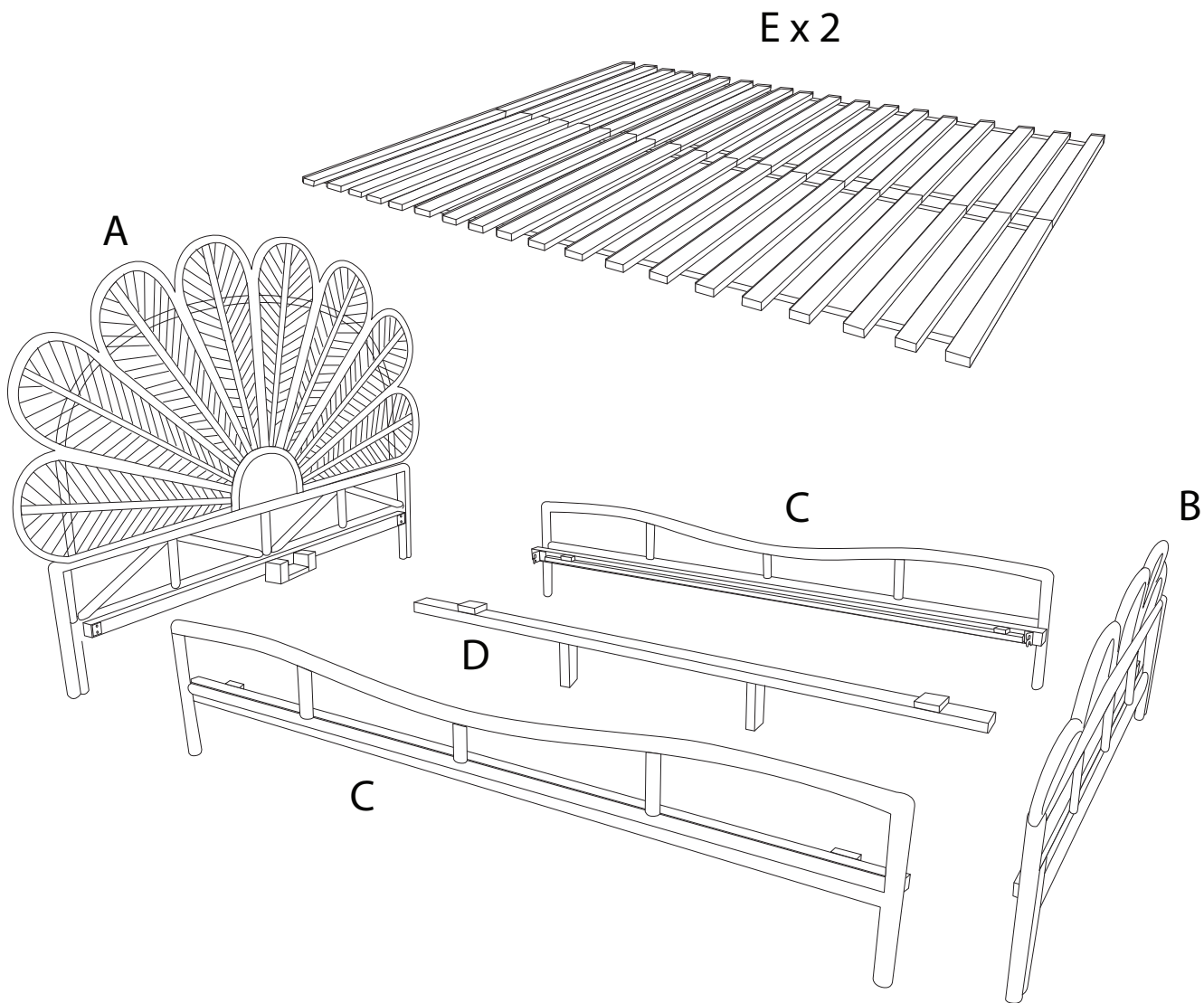

D

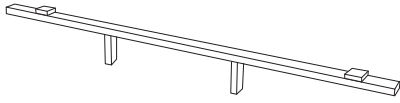

x 1

E

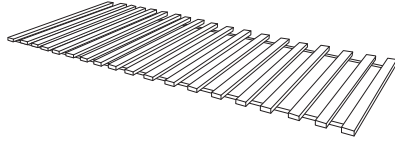

x 2

F

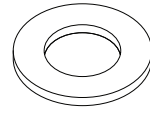

x 8

G

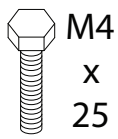

x 8

H

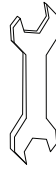

x 1

I

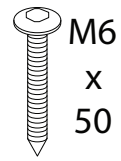

x 4

J

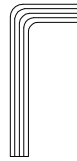

x 1

1

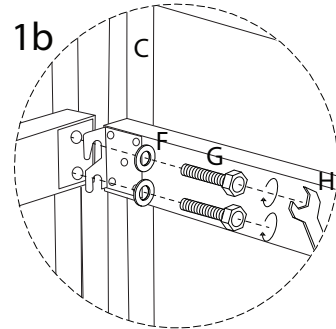
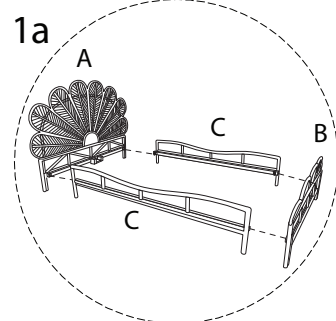
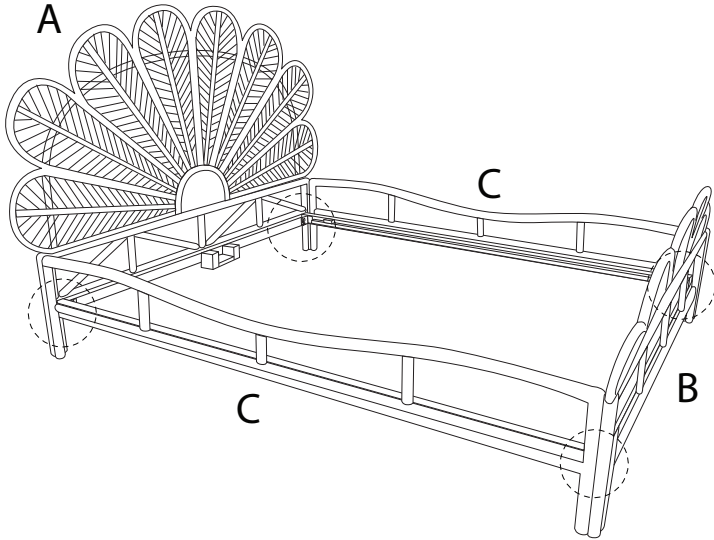
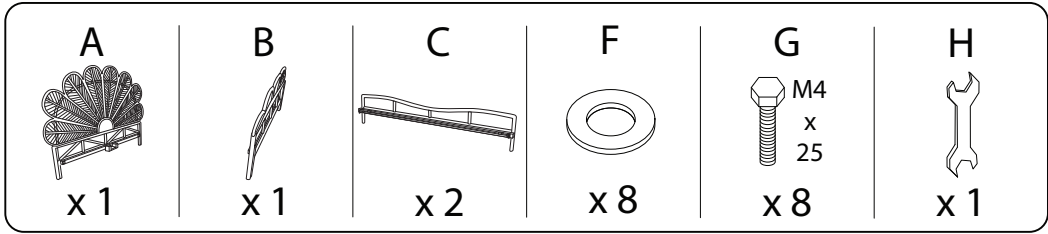

2

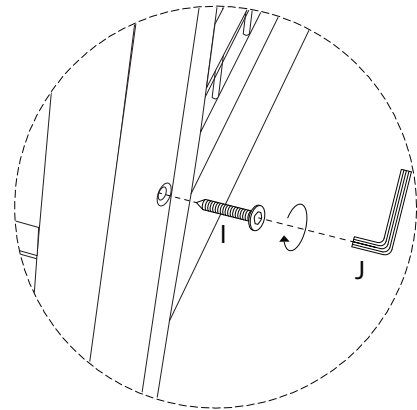
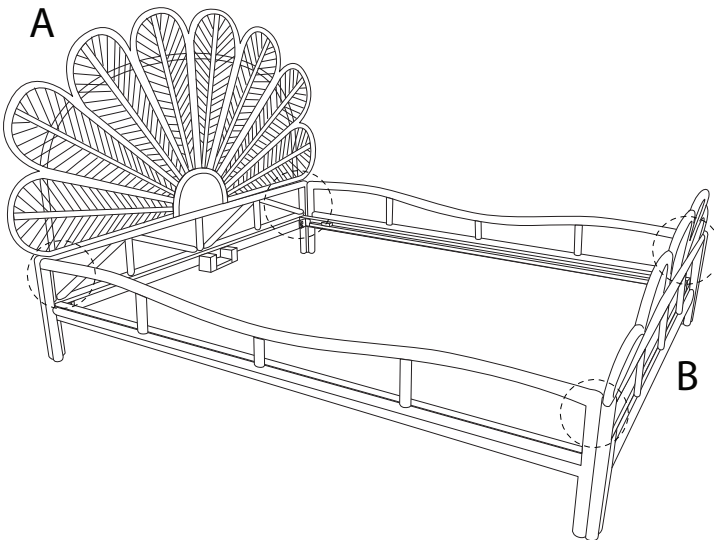
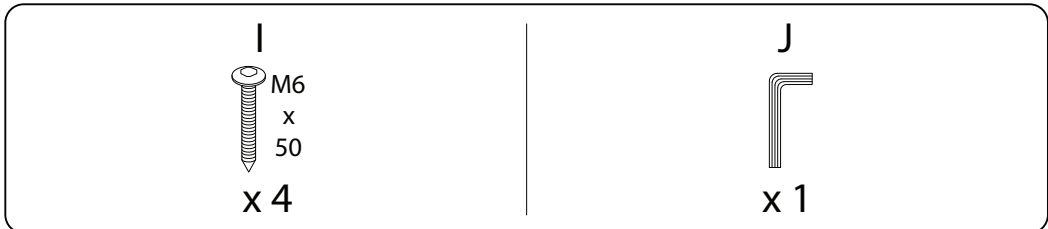

3

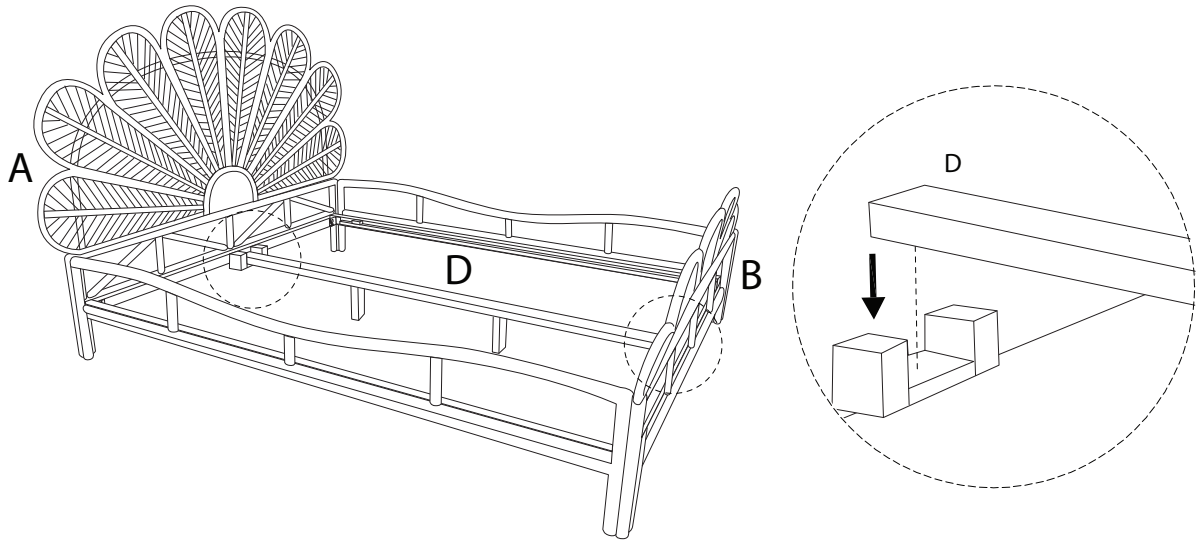
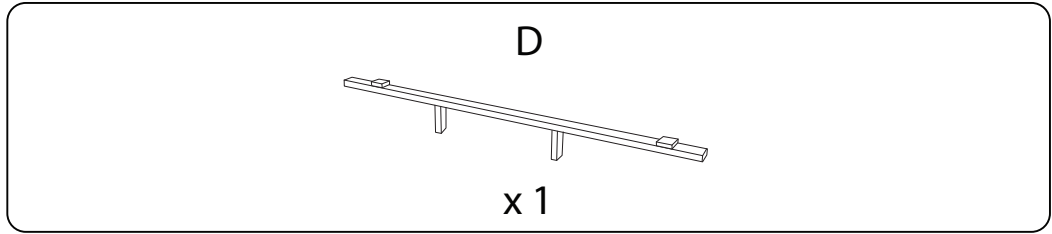

4

