

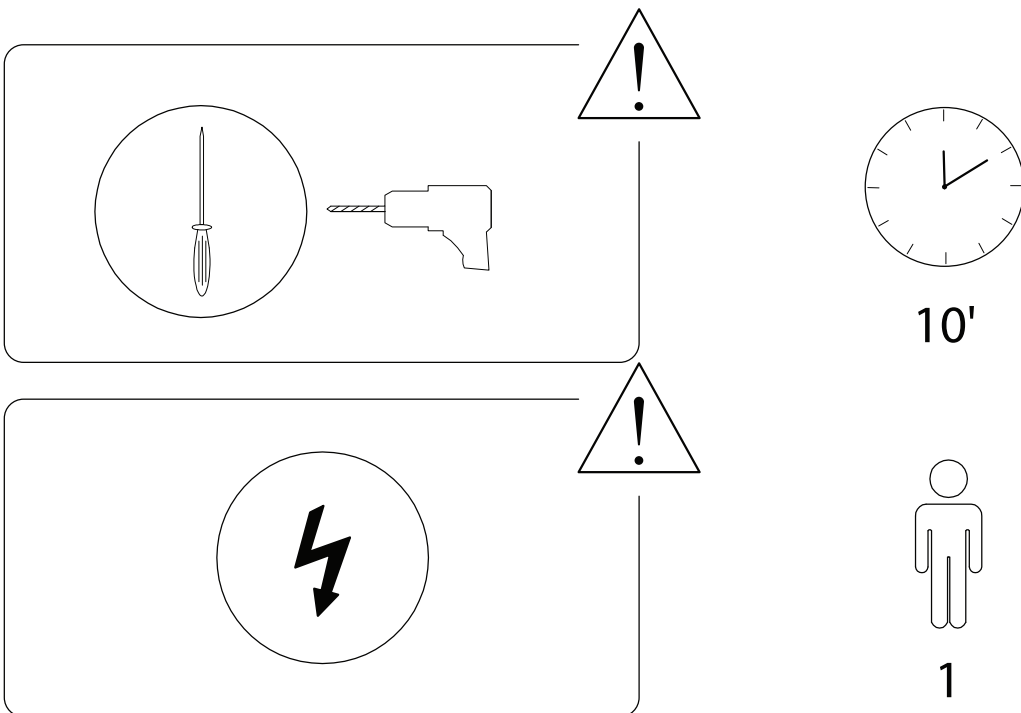

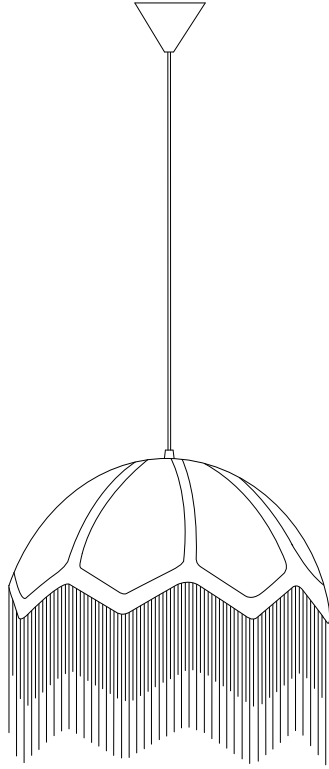

MILAGRO

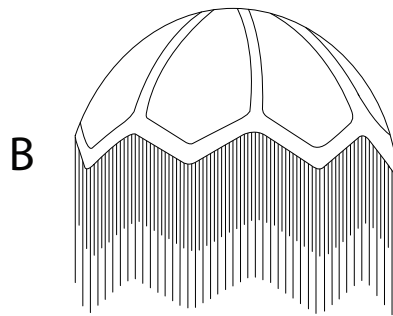

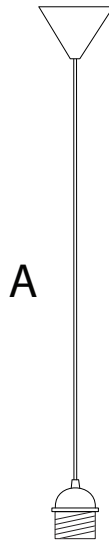

1/6

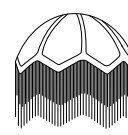
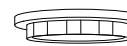

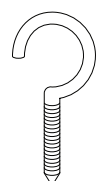
 <p>A</p> <p>x 1</p>	 <p>B</p> <p>x 1</p>	 <p>C</p> <p>x 1</p>	 <p>D</p> <p>x 1</p>	 <p>E</p> <p>x 1</p>
---	---	---	---	---

1

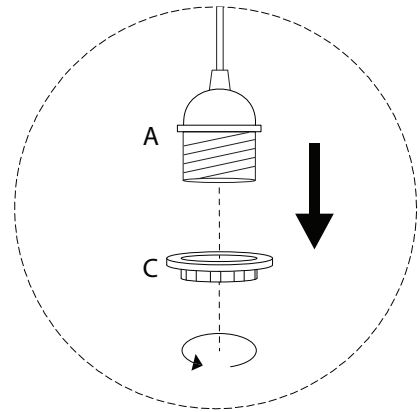
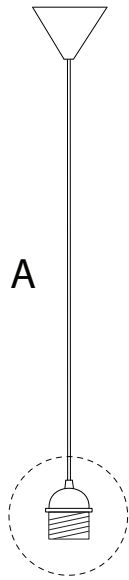
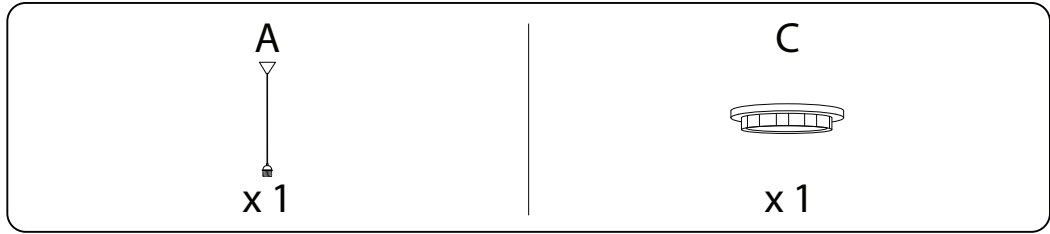

2

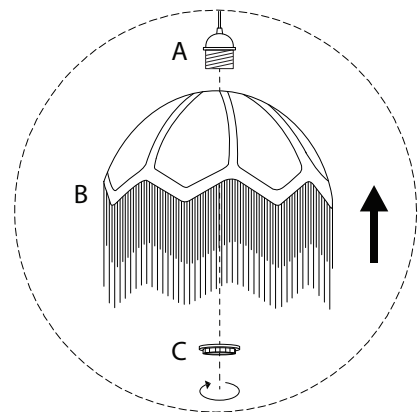
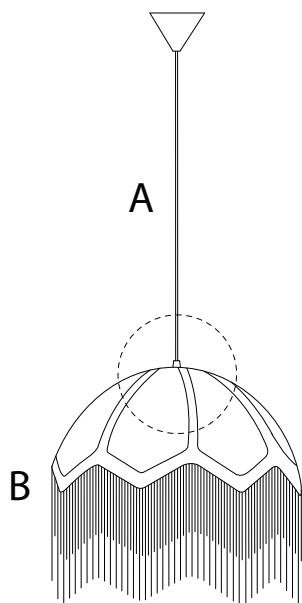
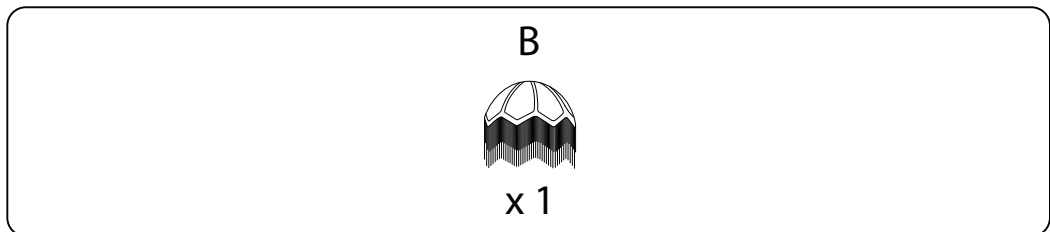

!

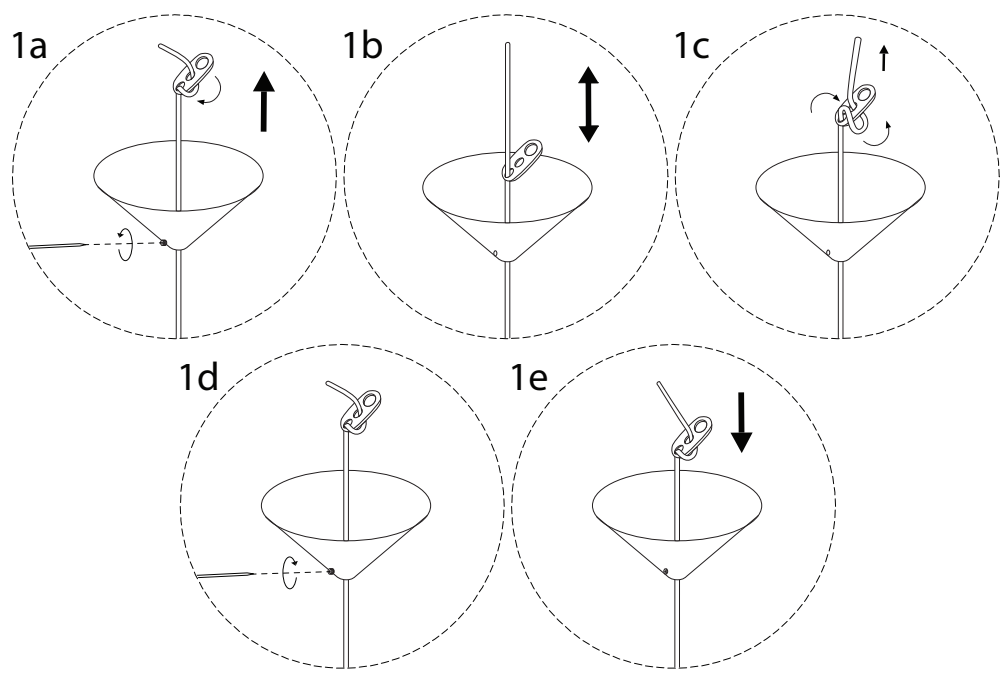
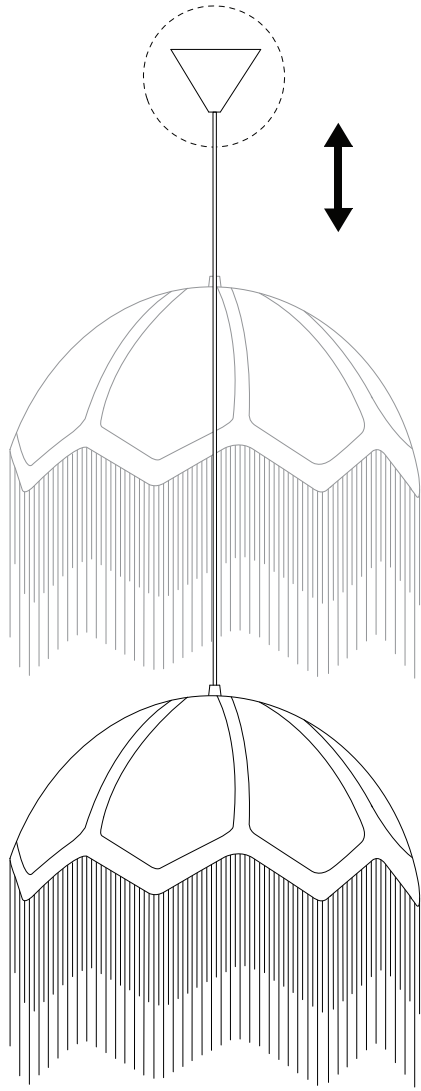

3

D



x 1

E



x 1

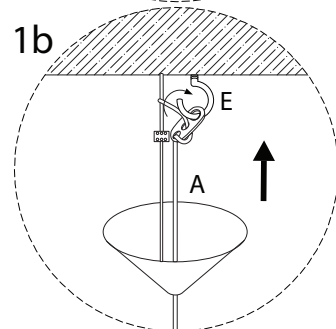
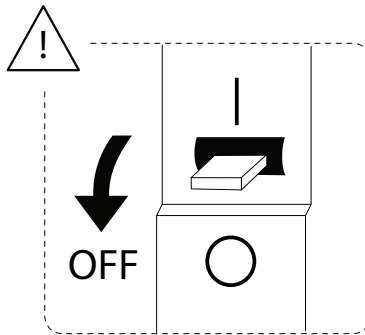
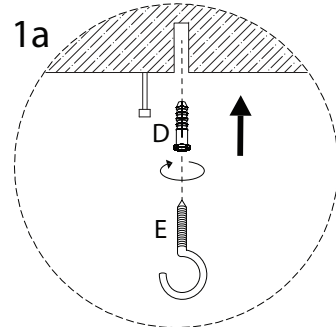

4

