

LAPPI

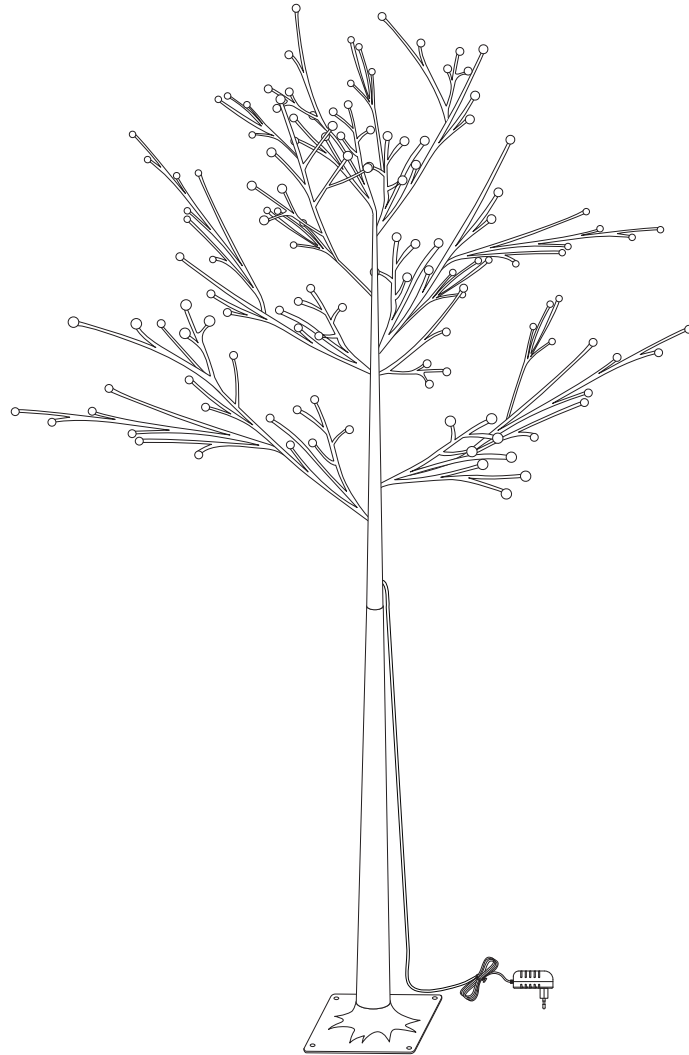

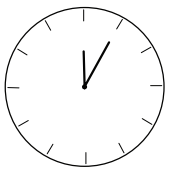

5'

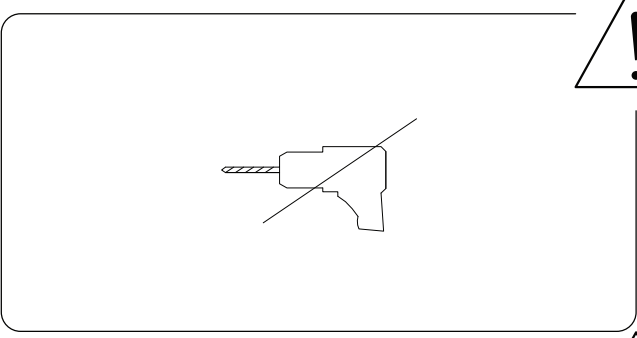
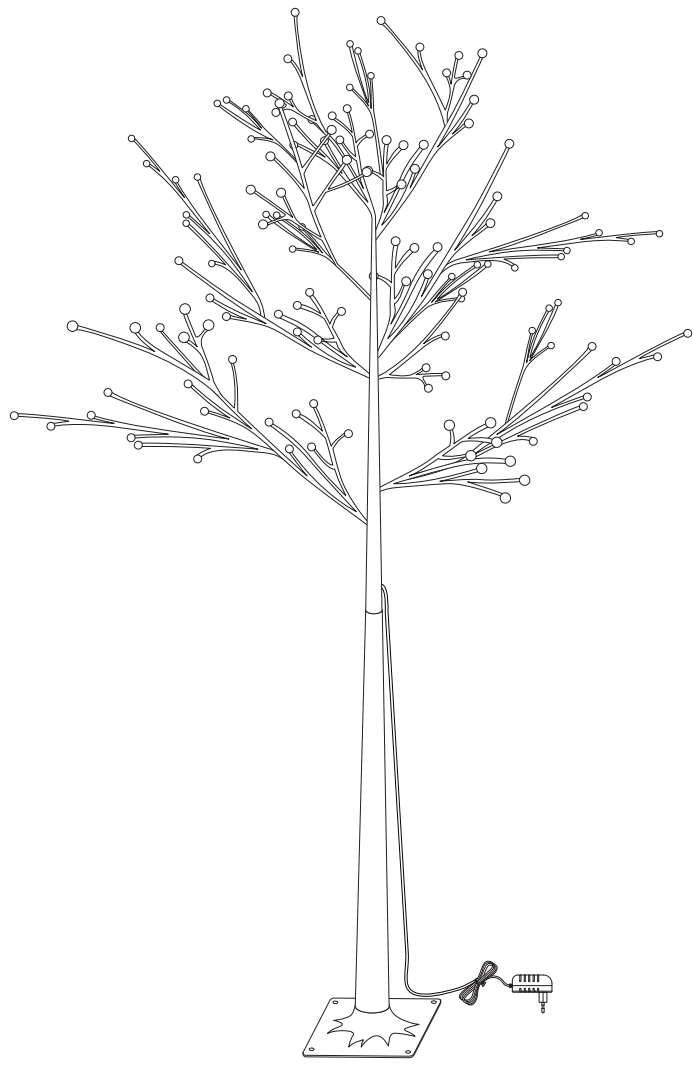
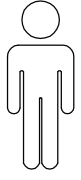
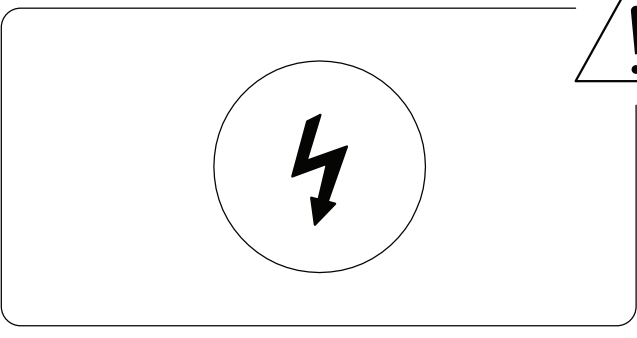

1

1/4

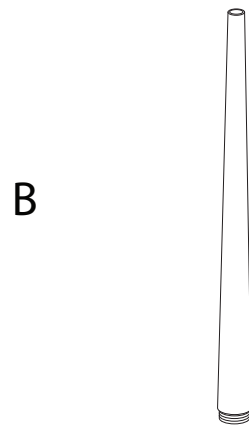

| A | B | C | D |
|-----|-----|-----|-----|
| | | | |
| x 1 | x 1 | x 1 | x 4 |

1

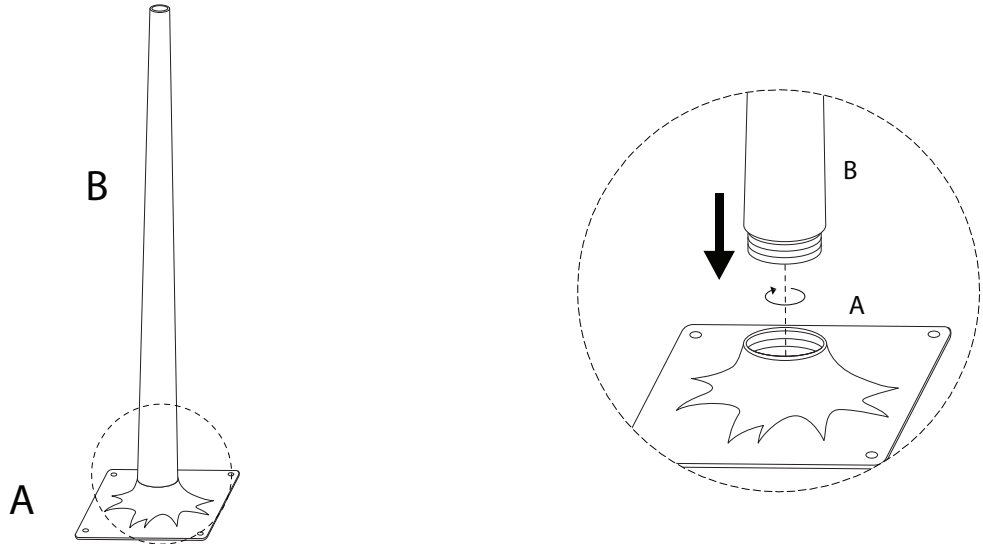
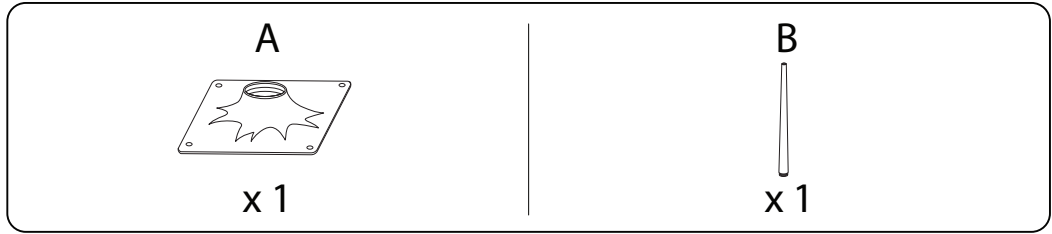

2

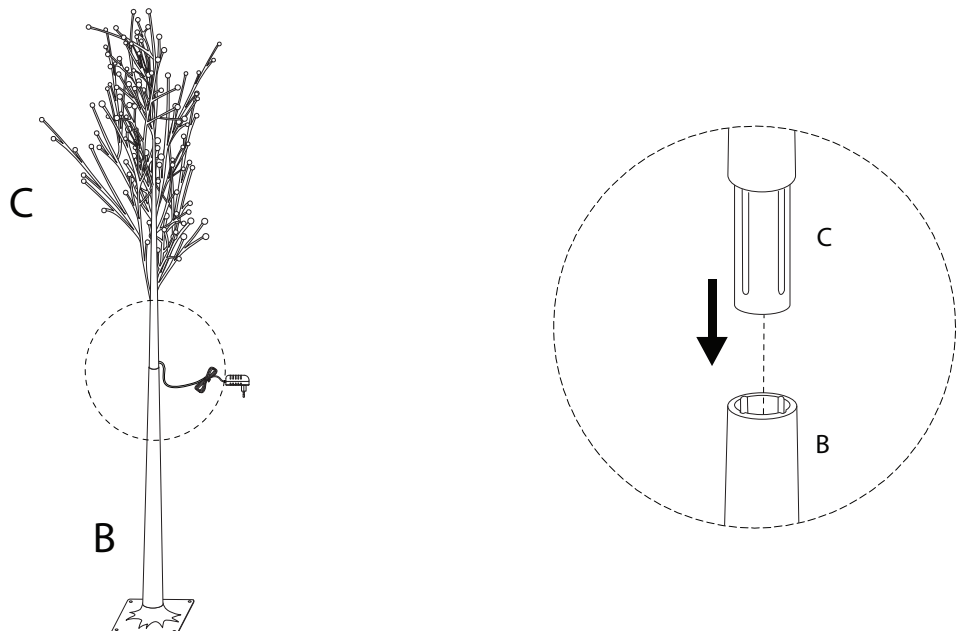
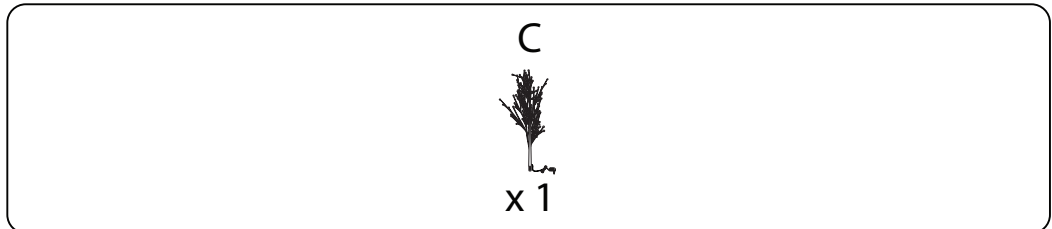

3

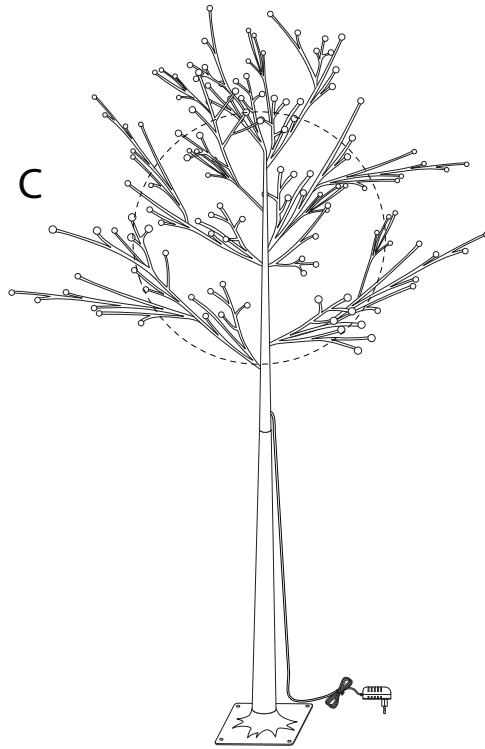

4

