

20'

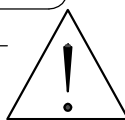
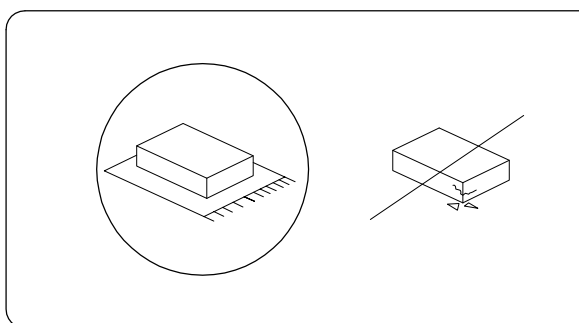

1

1/3

A

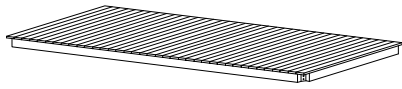

x 1

B



x 4

A

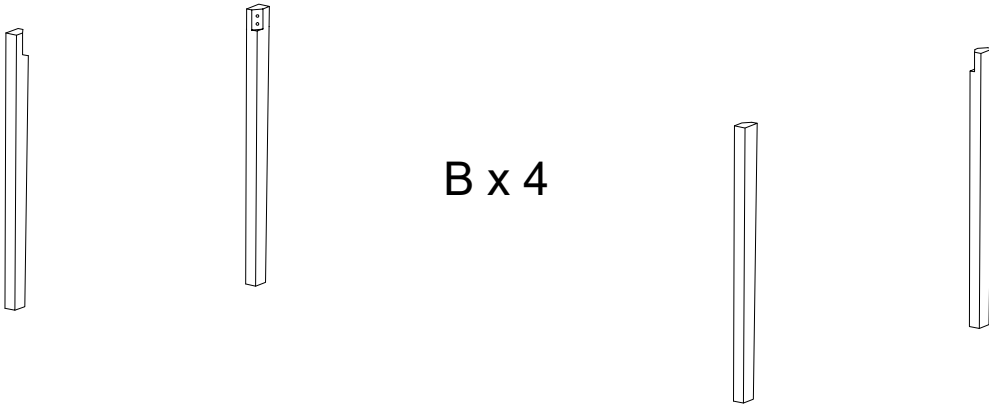
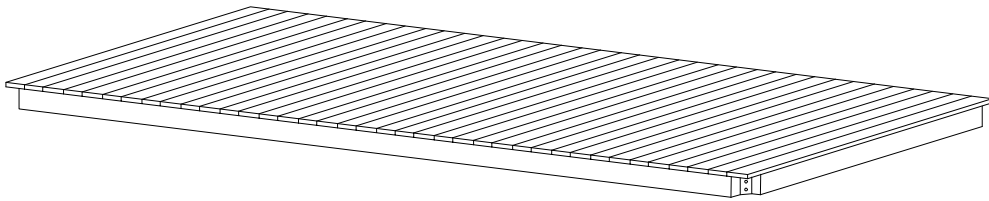

B x 4

C

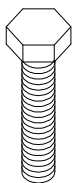

M8
x
50

x 8

D

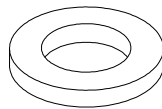

x 8

E

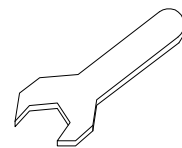

x 1

1

