

1/4

A

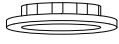

B

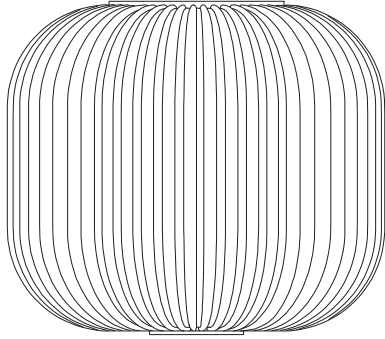

C

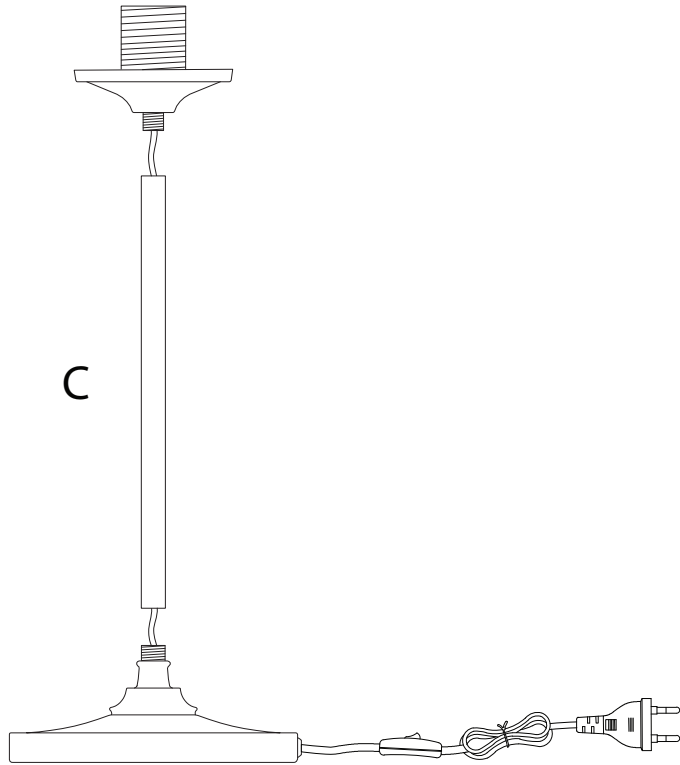

A

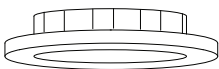

x 1

B

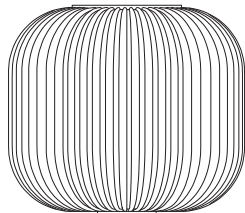

x 1

C

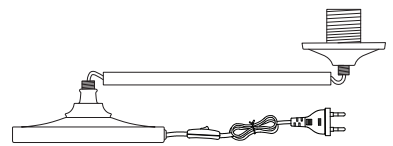

x 1

1

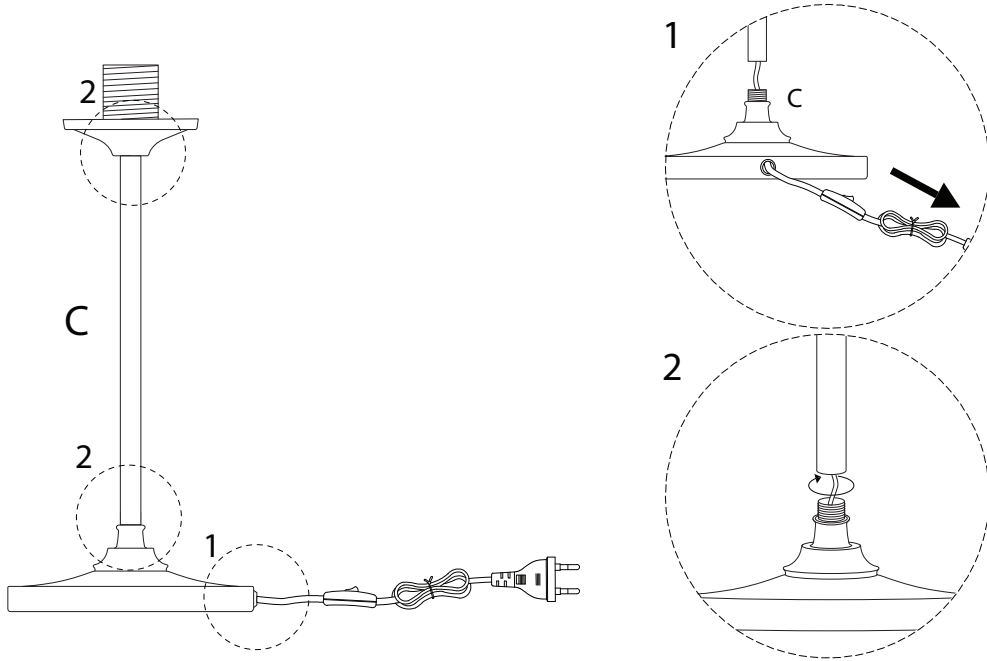
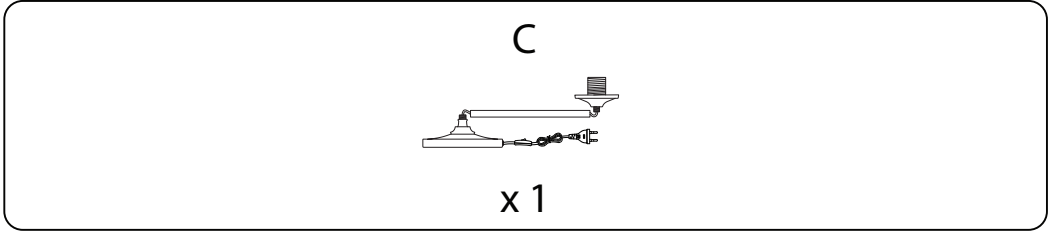

2

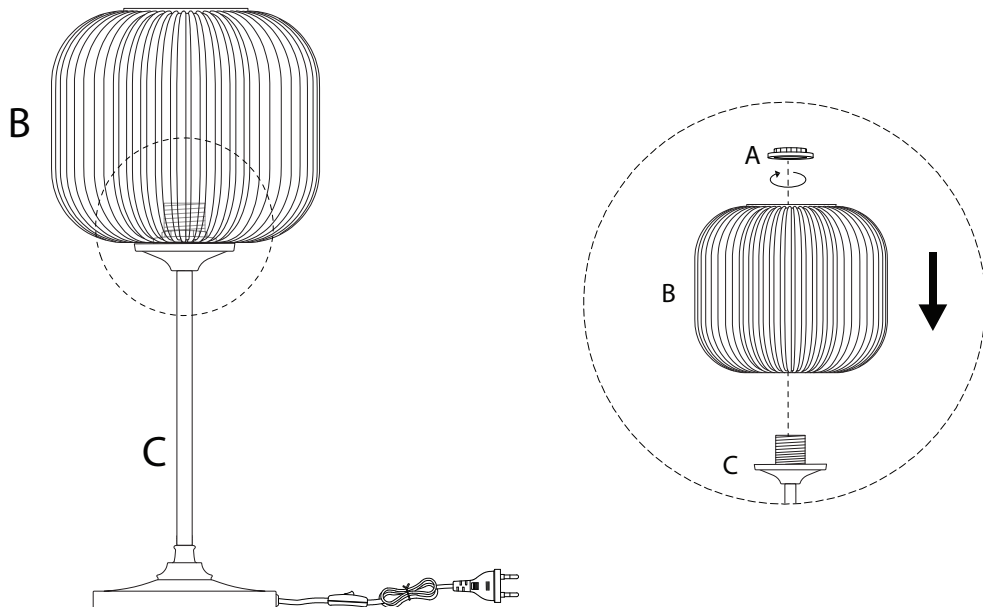
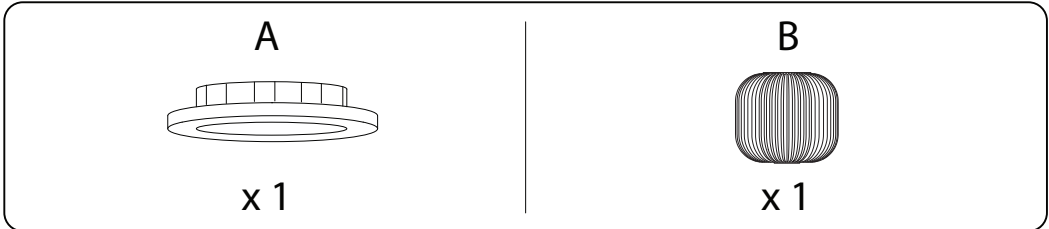

3

