

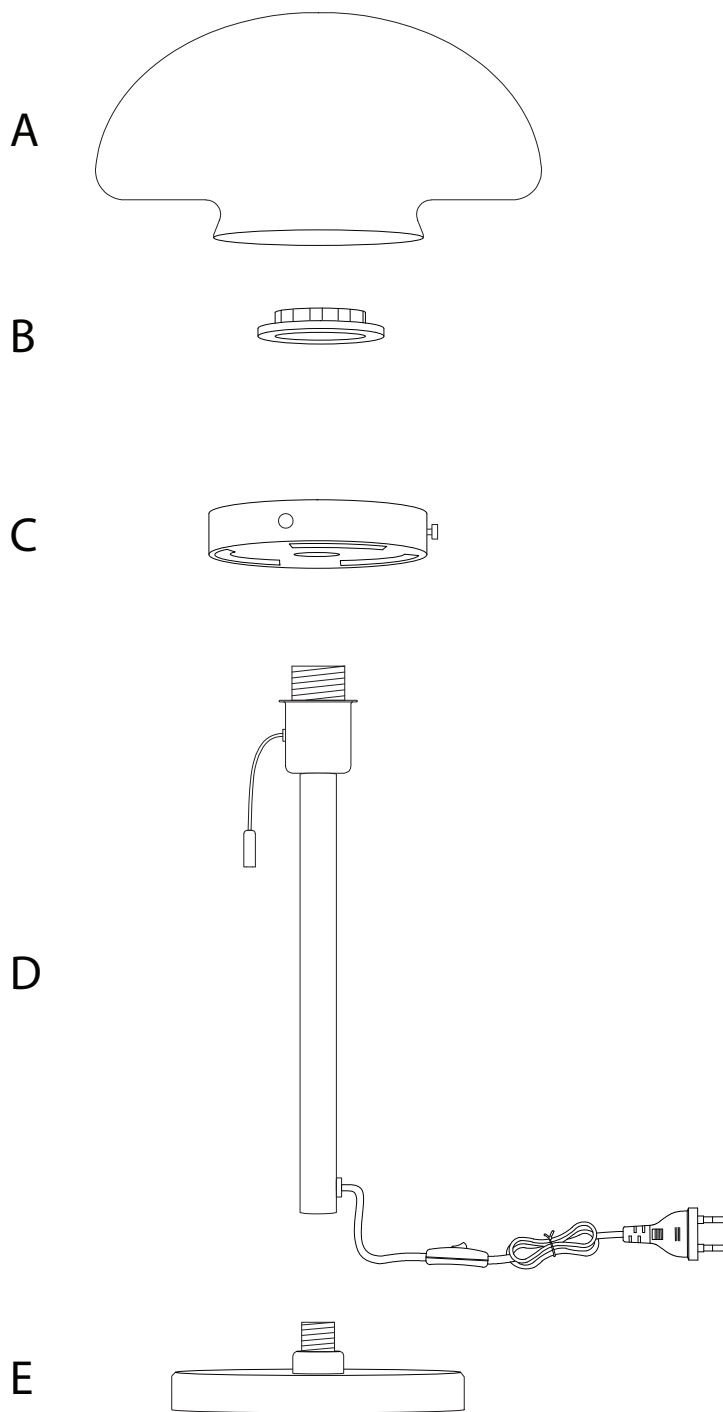

1/4

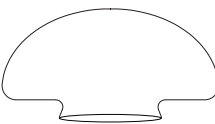

A	B	C	D	E
				
x 1	x 1	x 1	x 1	x 1

1

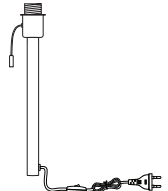
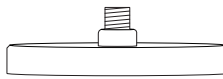
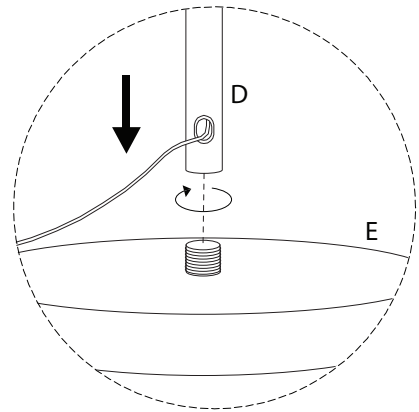
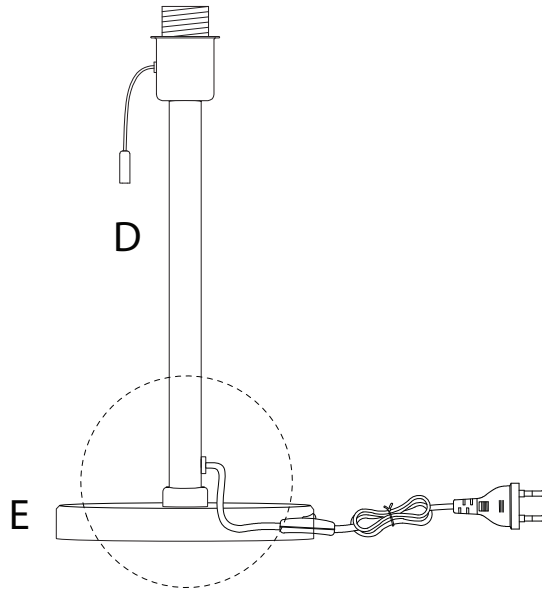
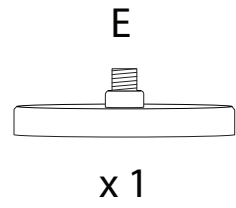
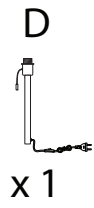

2

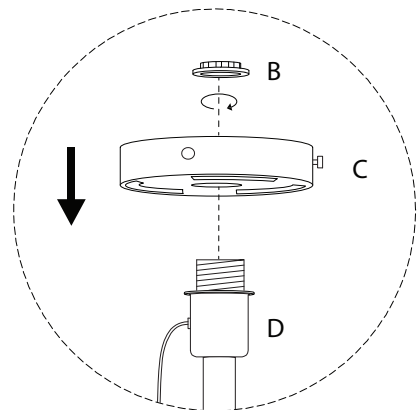
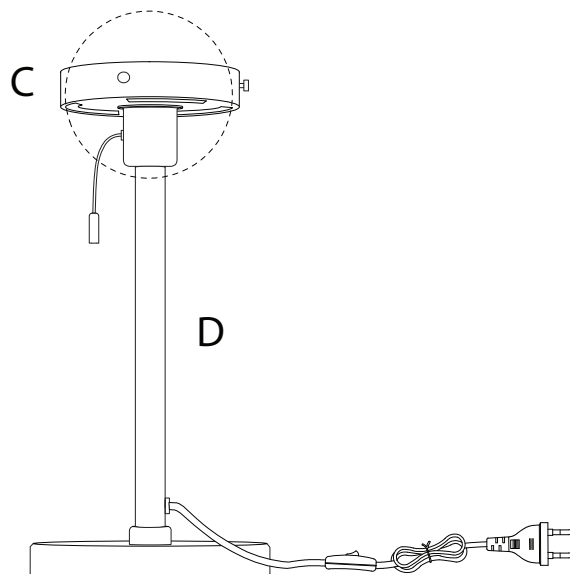
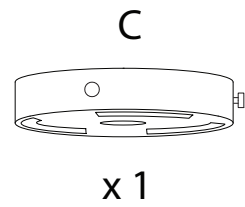
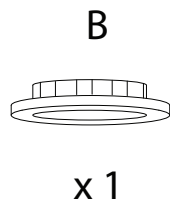

3

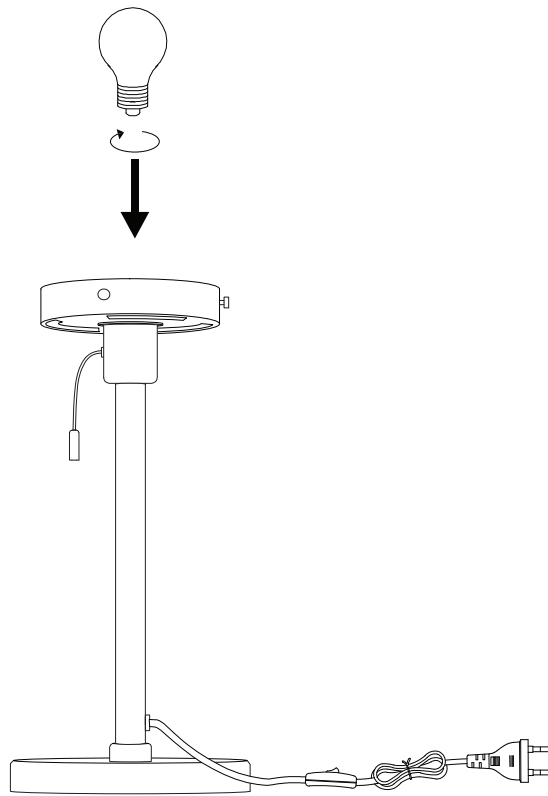

4

