

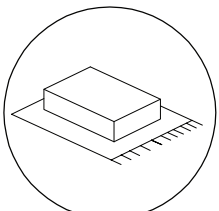

		10'
 		
		1
1/5		

A

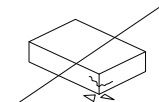

A

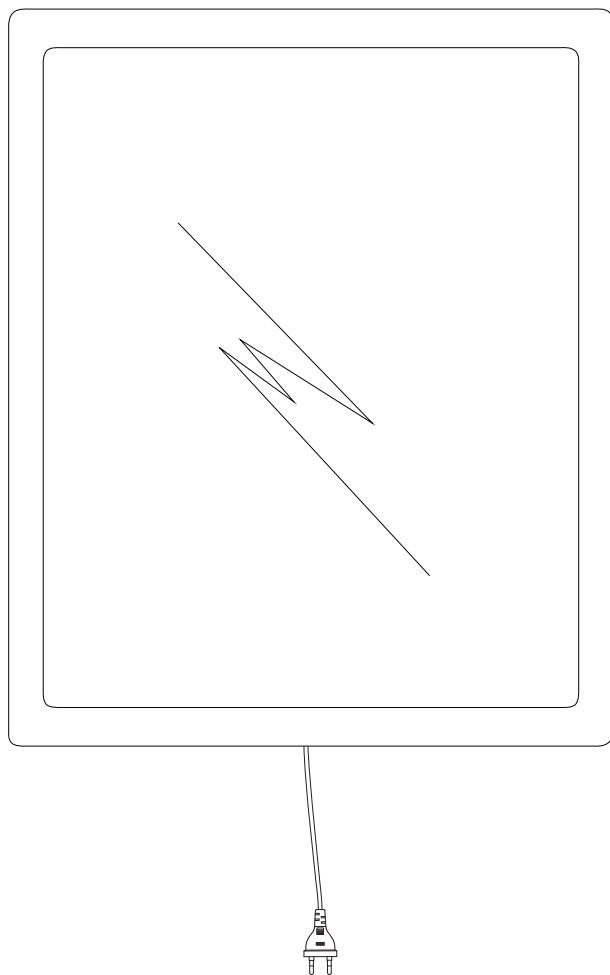
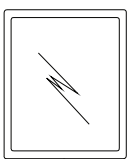

x 1

B



x 2

C

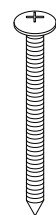

M5
x
40

x 2

1

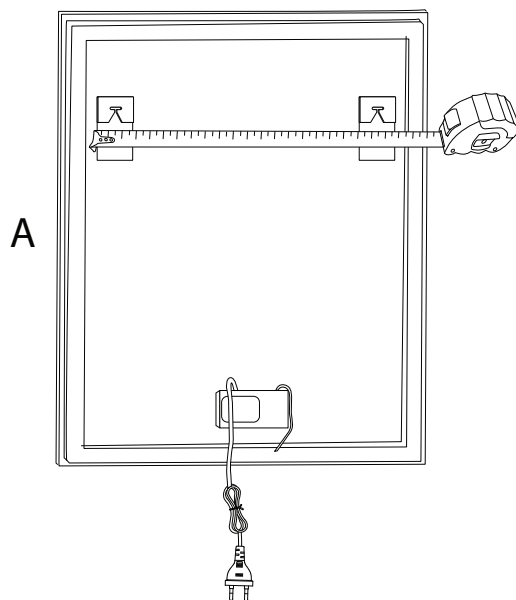
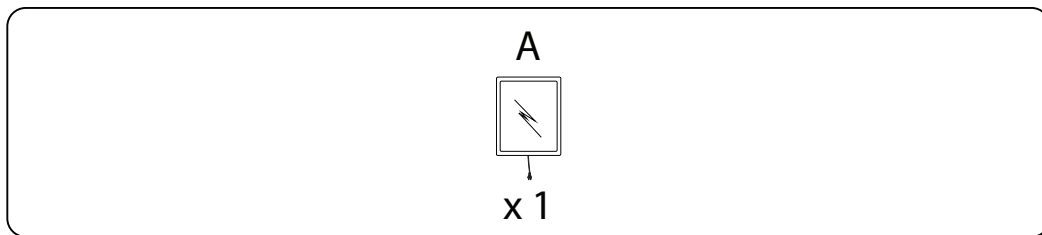

2

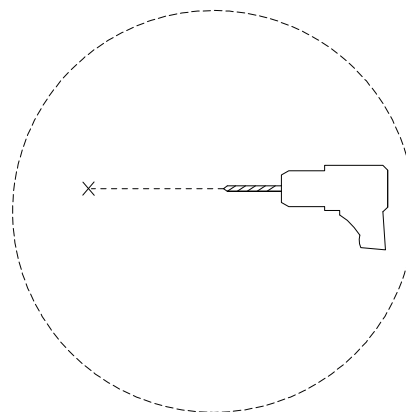
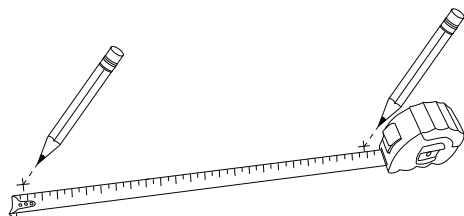

3

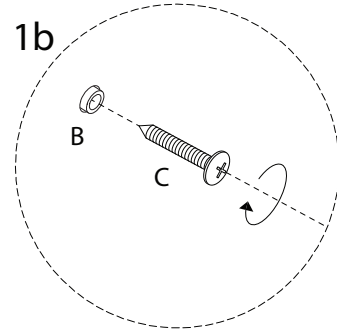
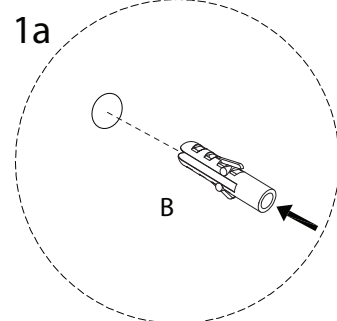
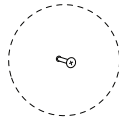
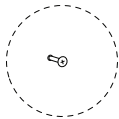
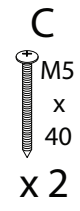
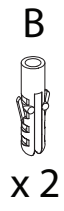

4

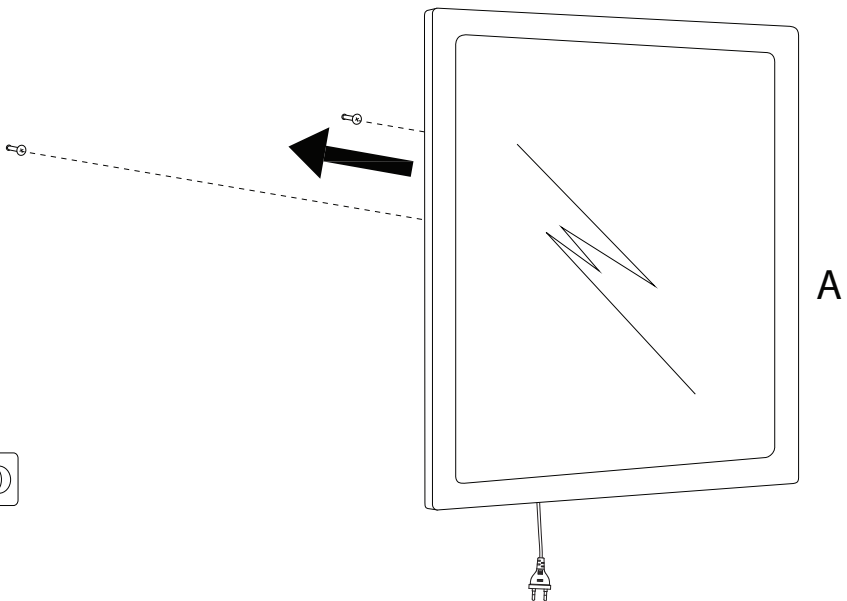

5

A

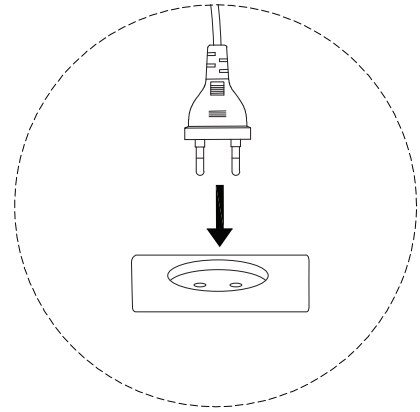
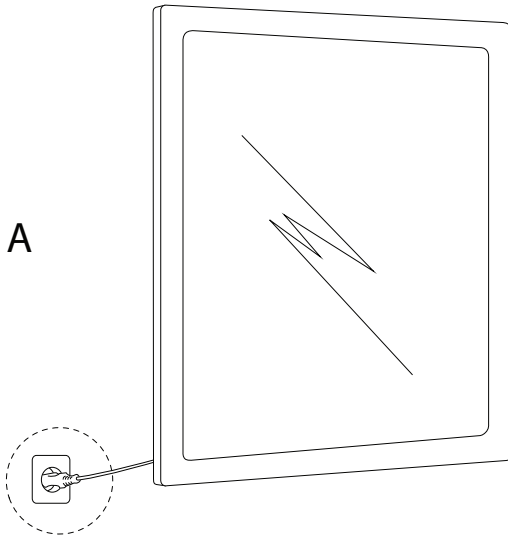

!

A

