

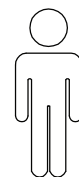

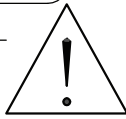

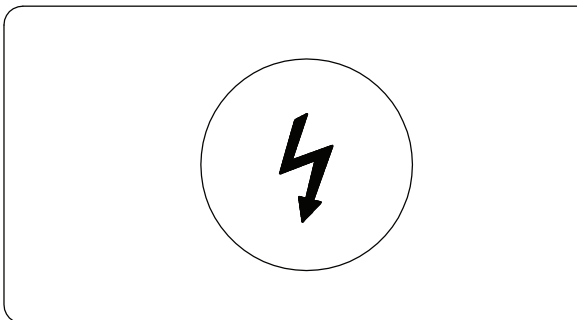

20'

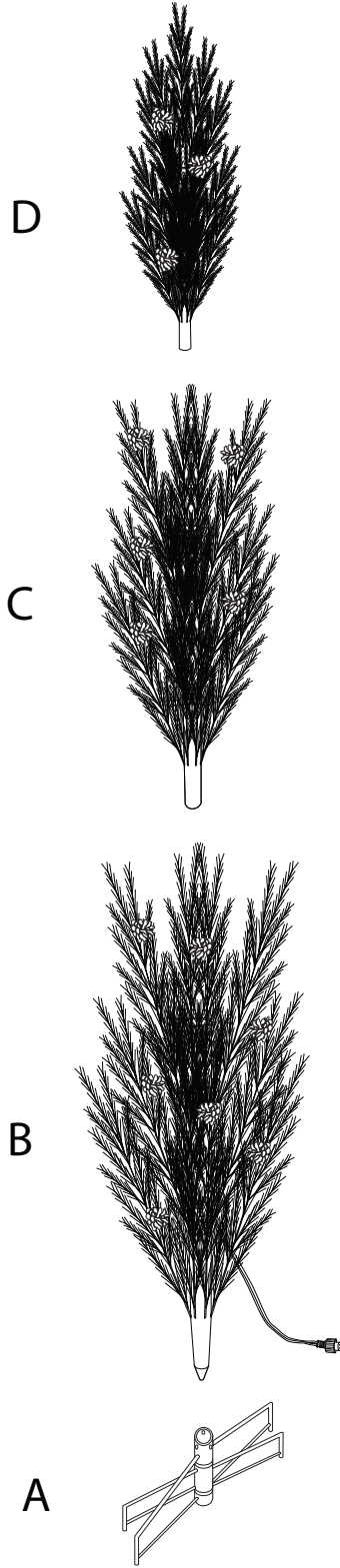
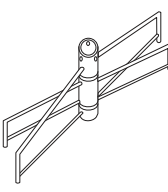

1

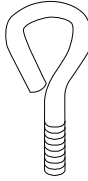

| | | | | | |
|---|---|---|---|---|---|
| <p>A</p>  <p>x 1</p> | <p>B</p>  <p>x 1</p> | <p>C</p>  <p>x 1</p> | <p>D</p>  <p>x 1</p> | <p>E</p>  <p>x 3</p> | <p>F</p>  <p>x 1</p> |
|---|---|---|---|---|---|

1

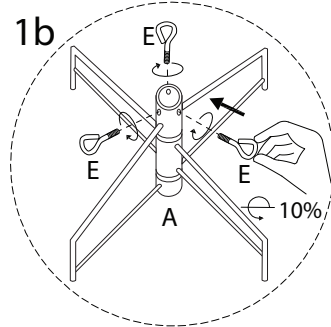
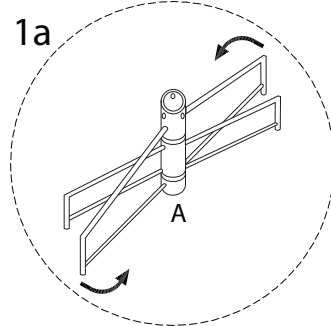
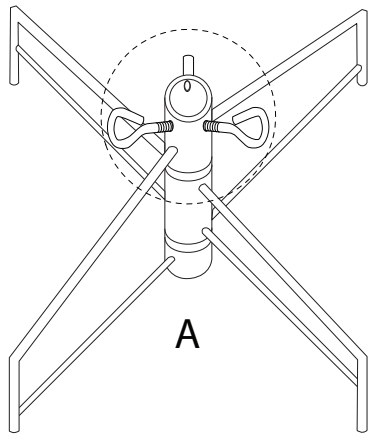
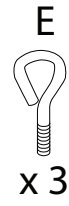
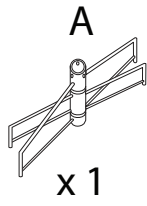

2

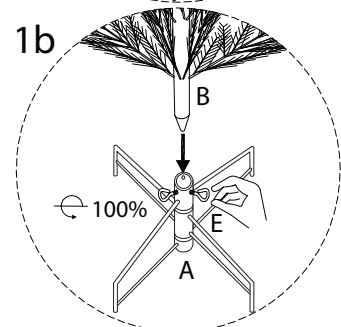
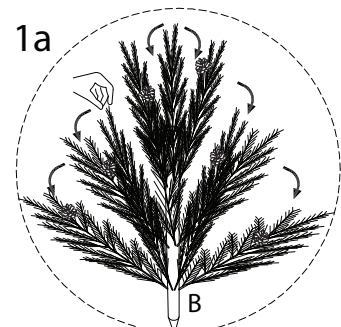
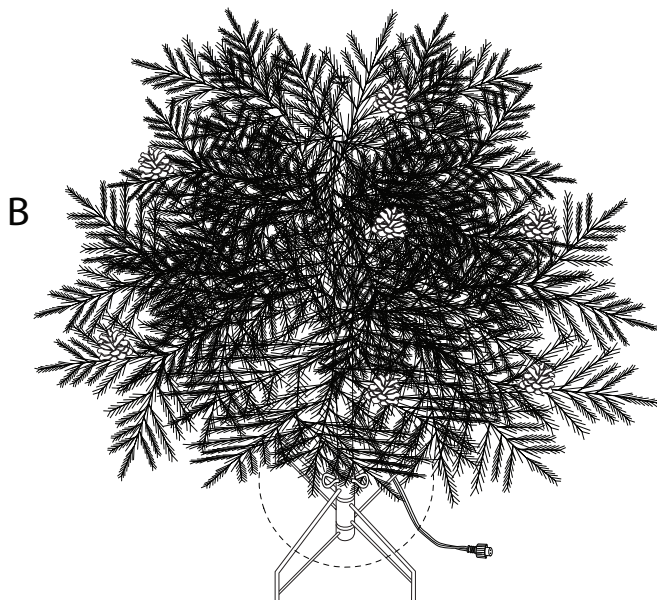

3

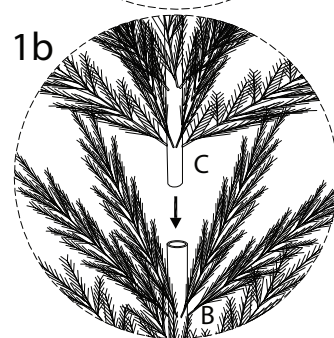
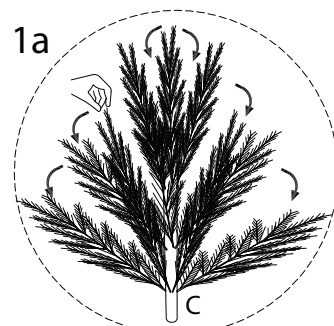
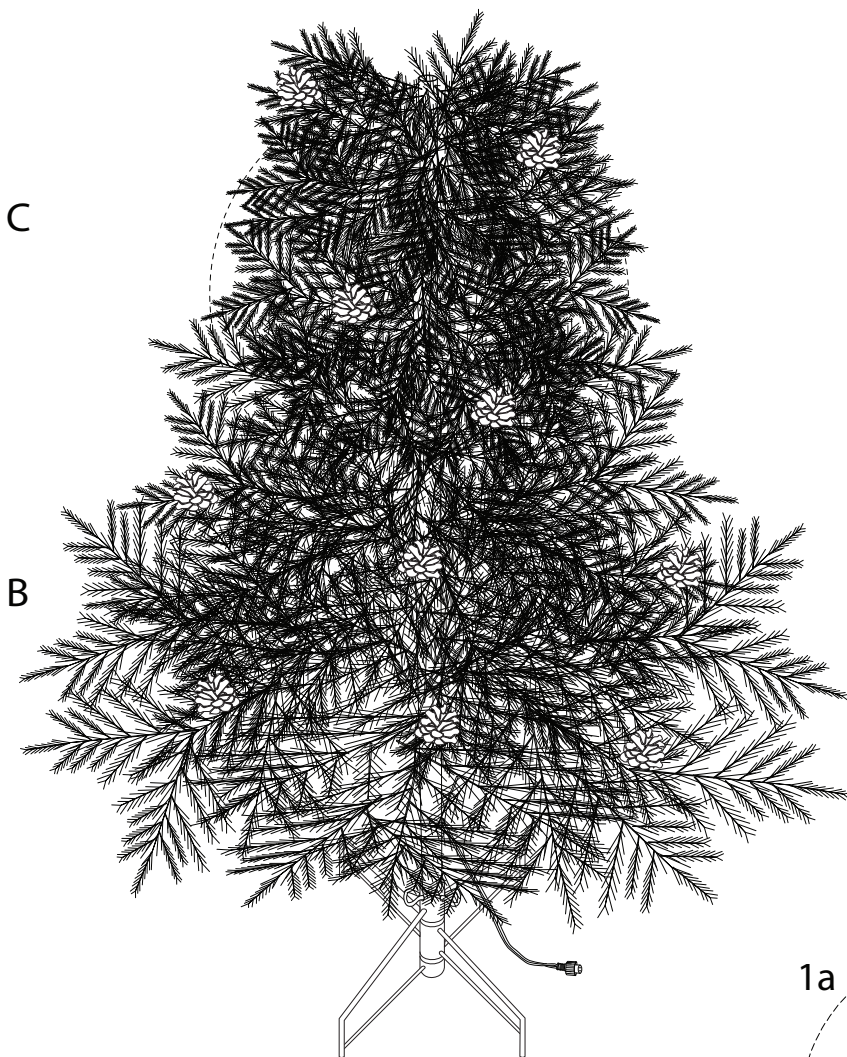

4

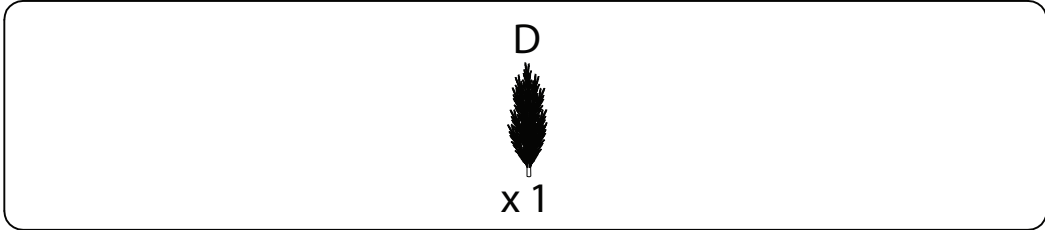

D

C

B

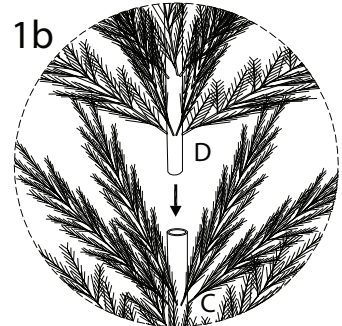
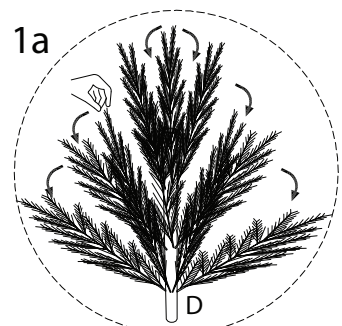
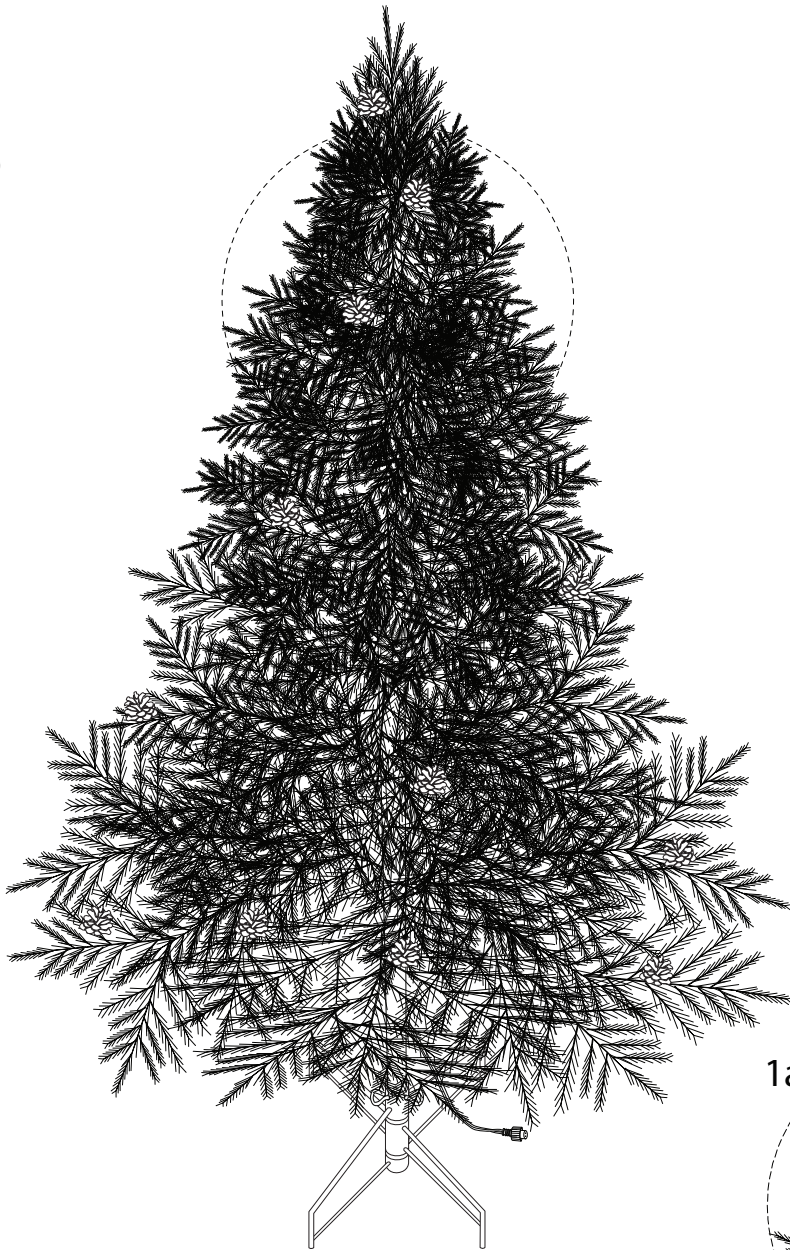

5

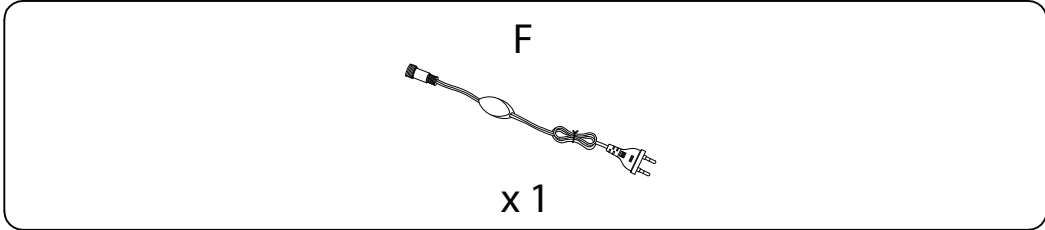

D

C

B

