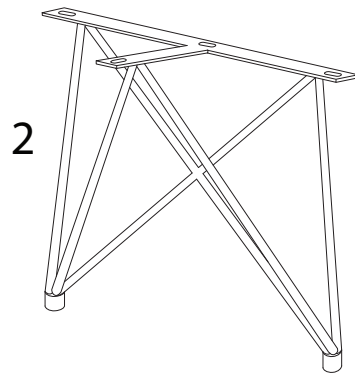
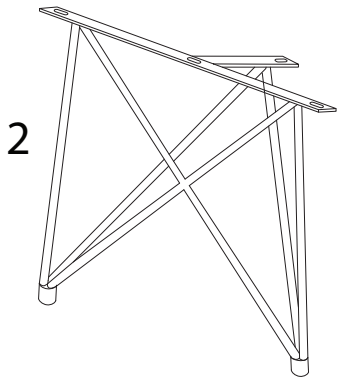
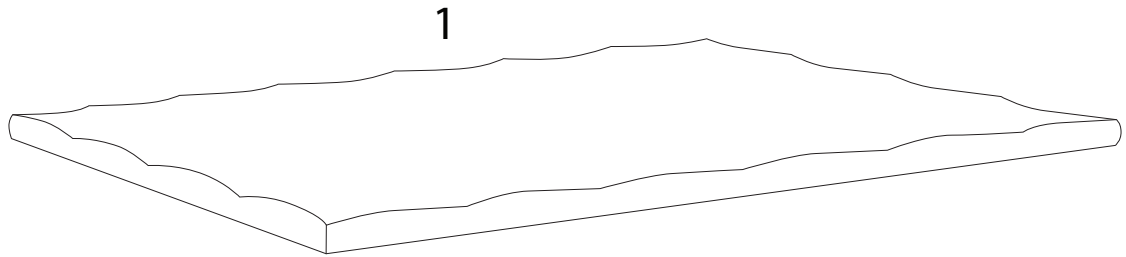

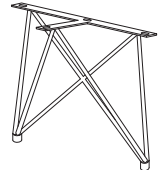
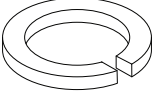
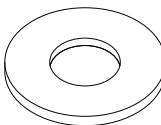
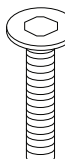
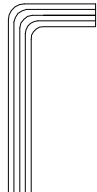



Diagram illustrating assembly instructions and safety warnings:

- Warning 1:** A warning triangle with an exclamation mark is positioned above a box. Inside the box, on the left, is a circular icon containing an L-shaped metal bracket. On the right is a power drill with a diagonal line through it, indicating that a power drill should not be used.
- Warning 2:** A second warning triangle with an exclamation mark is positioned above another box. Inside this box, on the left, is a circular icon showing a rectangular block being placed on a textured surface. On the right is a diagram of a rectangular block with a diagonal line through it, indicating that the block should not be placed on a soft or uneven surface.
- Time:** A clock icon is shown next to the text "10'", indicating an estimated assembly time of 10 minutes.
- Personnel:** An icon of a person is shown next to the number "2", indicating that two people are required for assembly.



1	2	A	B	C	D
					
x 1	x 2	x 8	x 8	M5 x 23 x 8	x 1

1

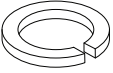
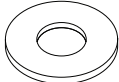
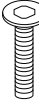
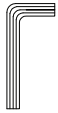
<p>1</p>  <p>x 1</p>	<p>2</p>  <p>x 2</p>	<p>A</p>  <p>x 8</p>	<p>B</p>  <p>x 8</p>	<p>C</p>  <p>M5 x 23</p> <p>x 8</p>	<p>D</p>  <p>x 1</p>
---	---	---	--	--	---

