

30'

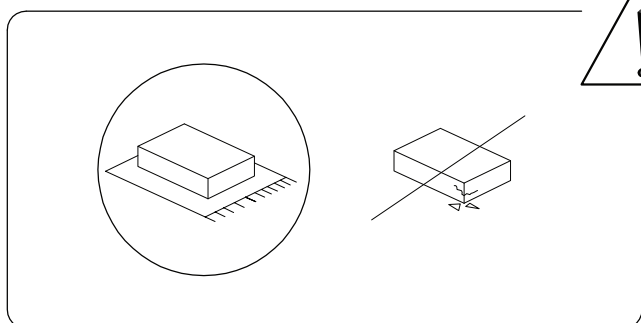

1

1/5

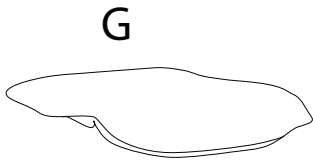

D

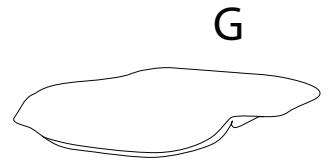
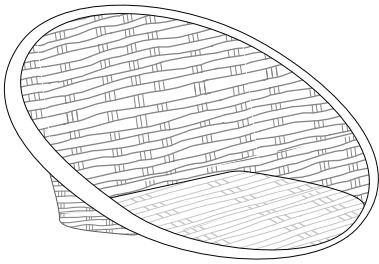

D

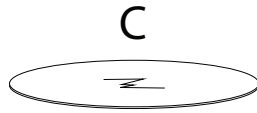
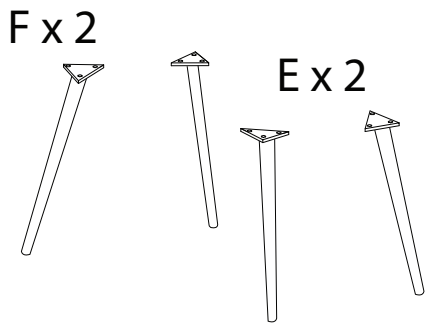
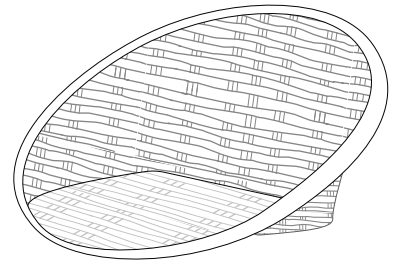

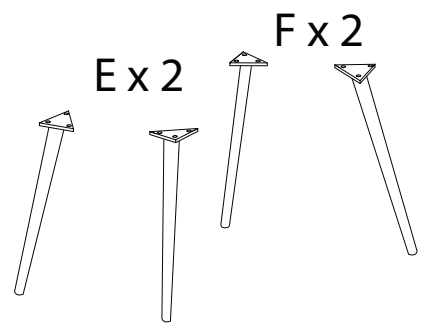
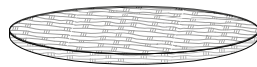

A

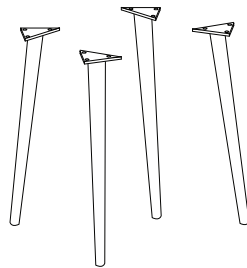

B x 4

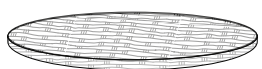

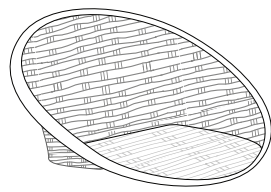
<p>A</p>  <p>x 1</p>	<p>B</p>  <p>x 4</p>	<p>C</p>  <p>x 1</p>	<p>D</p>  <p>x 2</p>
---	---	--	---

E



x 4

F



x 4

G

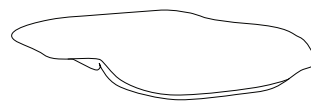

x 2

1



x 36

2

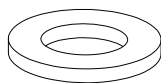



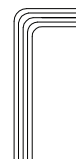

x 36

3

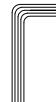
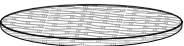

x 1

1



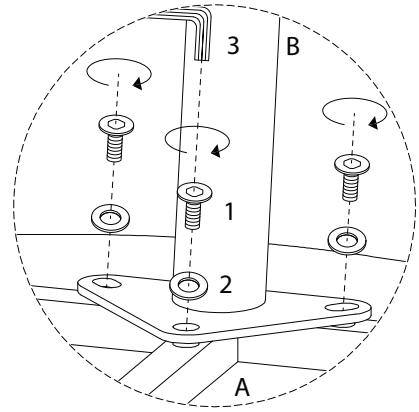
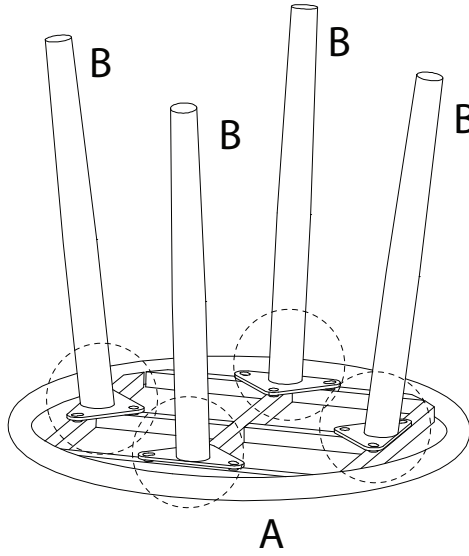

<p>1</p>  <p>M6 x 20</p> <p>x 12</p>	<p>2</p>  <p>x 12</p>	<p>3</p>  <p>x 1</p>	<p>A</p>  <p>x 1</p>	<p>B</p>  <p>x 4</p>
---	--	---	---	---

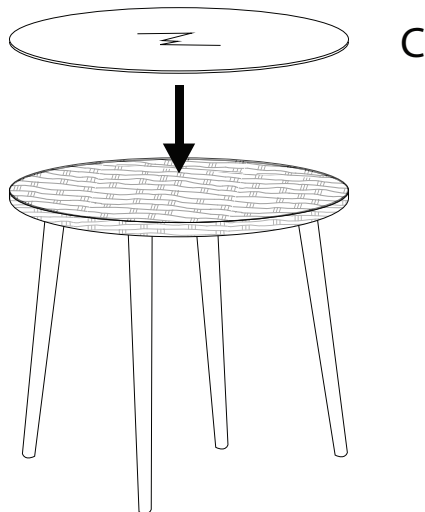
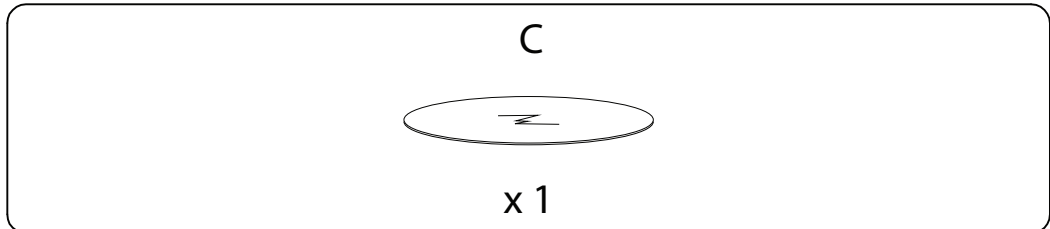

2

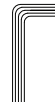
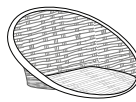

3 x 2

1  M6 x 20 x 12	2  x 12	3  x 1	D  x 1	E  x 2	F  x 2
--	--	---	--	---	---

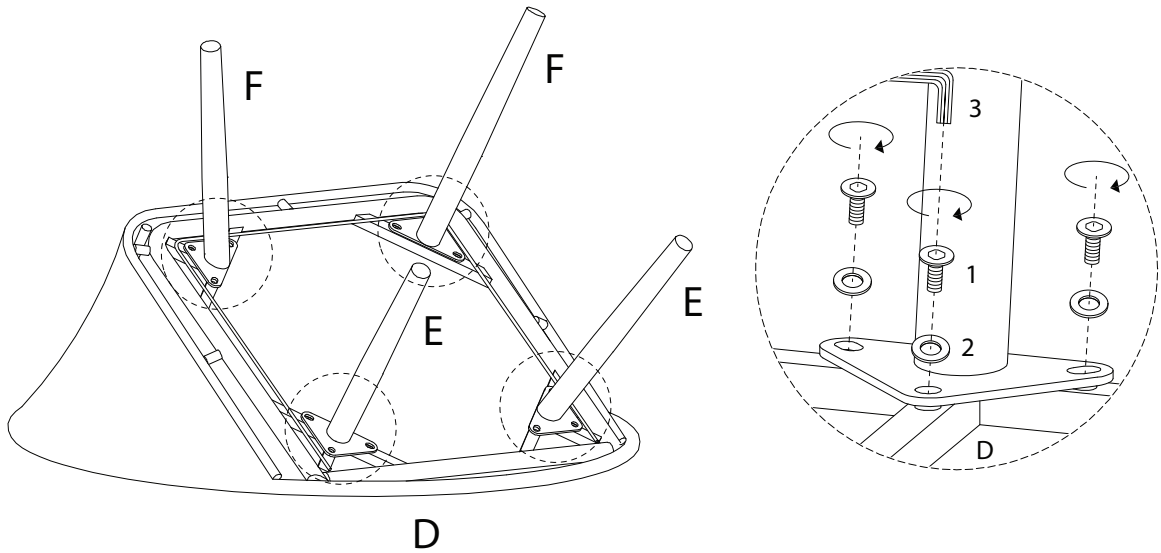

4 x 2

