

A rectangular box containing a circular inset with an L-shaped metal bracket. To the right of the inset is a power drill with a diagonal line through it, indicating that power tools should not be used on this part.		
<p>30'</p>		
A rectangular box containing a circular inset with a stack of three books on a surface. To the right is a diagram of a rectangular block with a diagonal line through it, indicating that heavy objects should not be placed on the furniture.		
<p>1</p>		

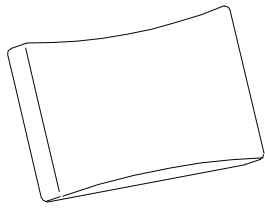

G x 2

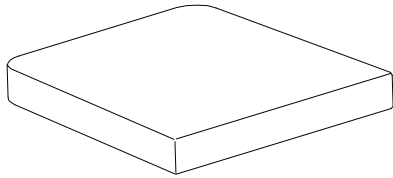
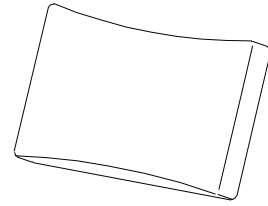

F x 2

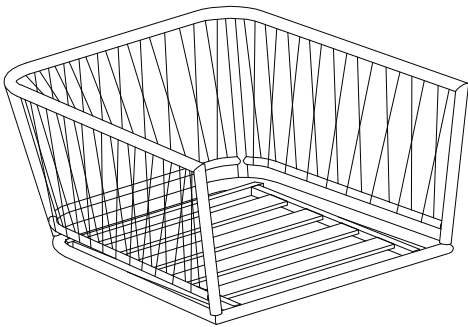
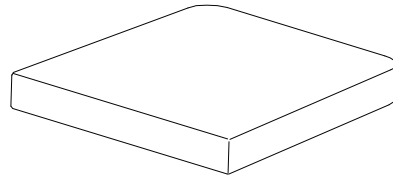

C x 2

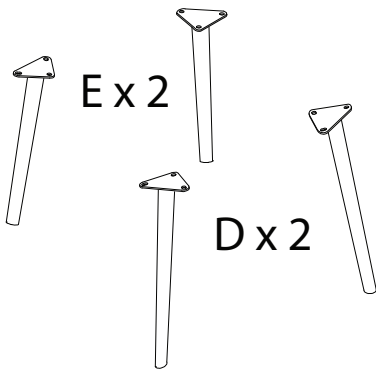
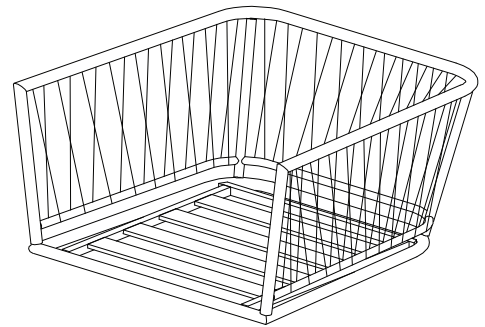

E x 2

D x 2

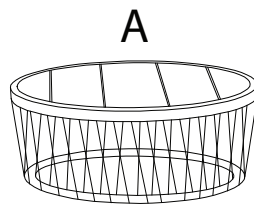

A

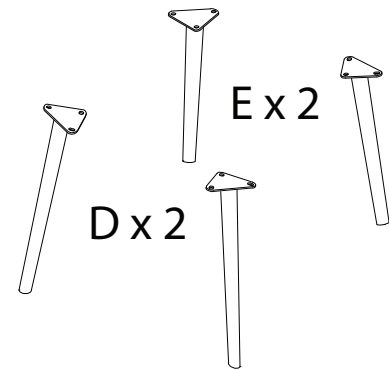

E x 2

D x 2

B x 4

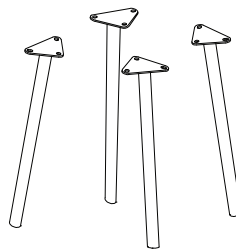

A

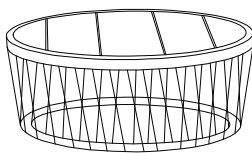

x 1

B



x 4

C

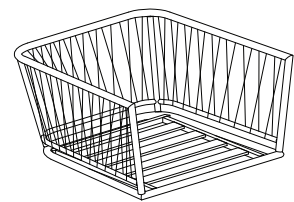

x 2

D



x 4

E



x 4

F

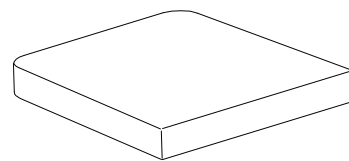

x 2

G

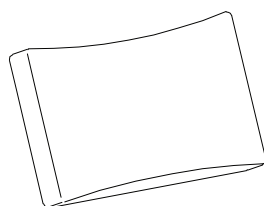

x 2

1



x 36

2

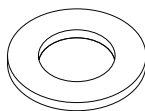

x 36

3

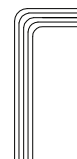

x 1

1

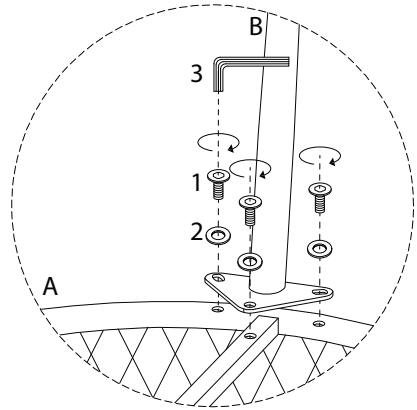
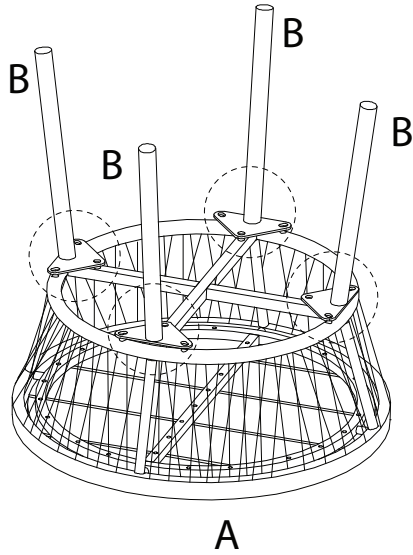
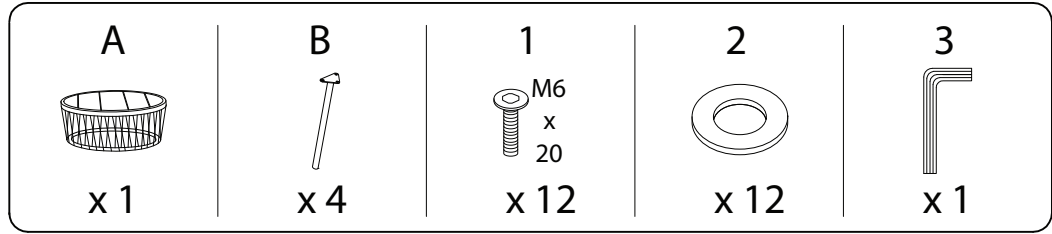

2 x 2

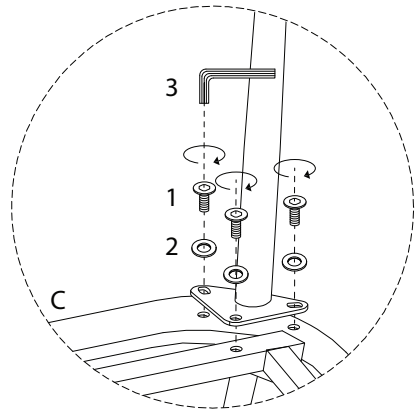
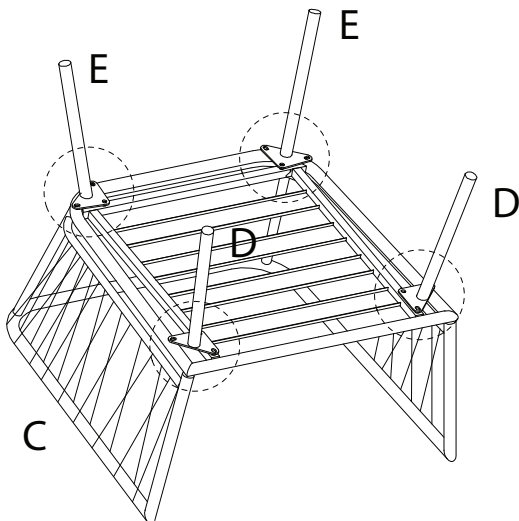
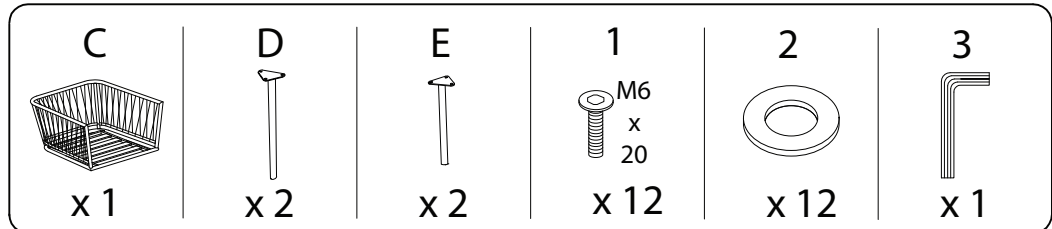

3 x 2

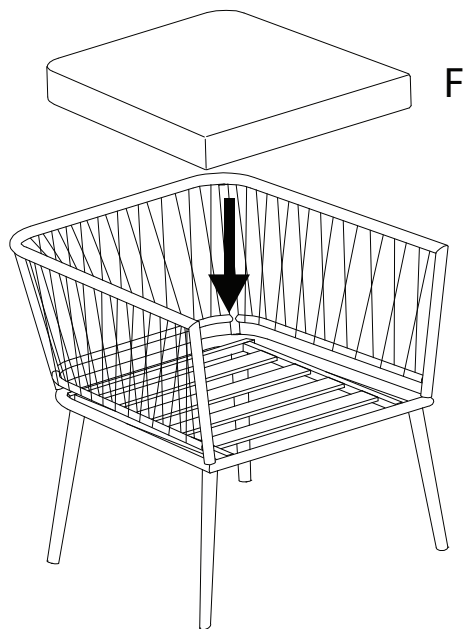
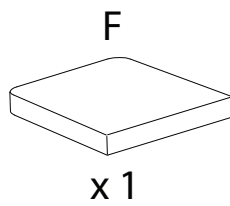

4 x 2

