

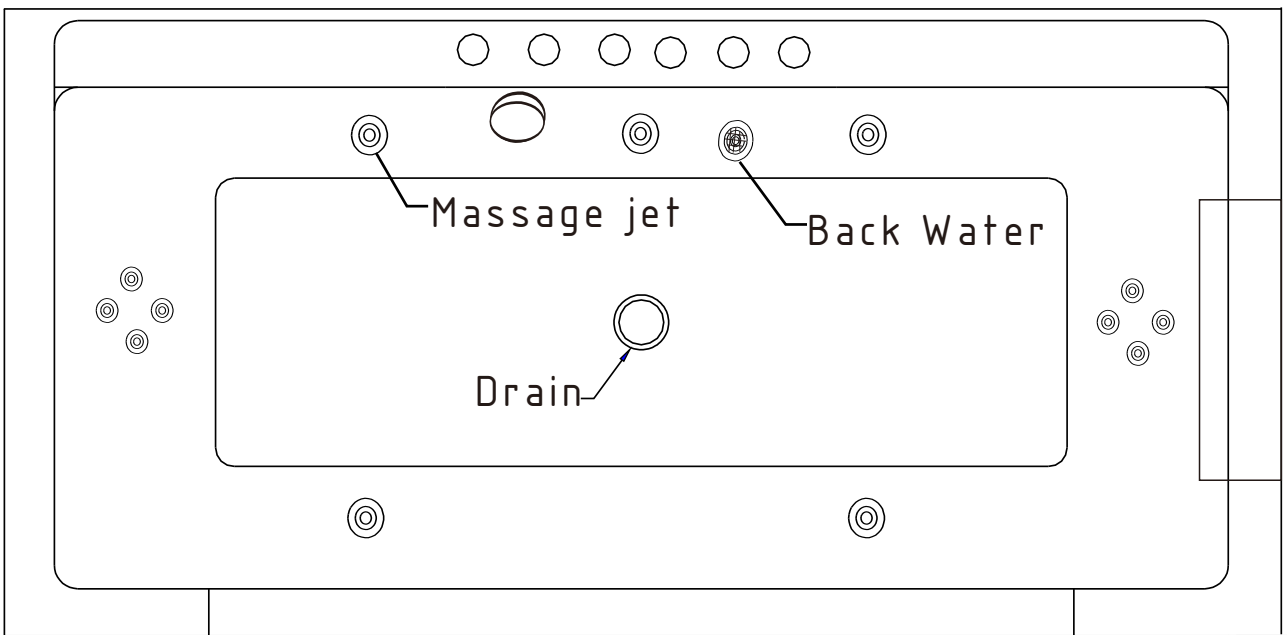

17589

1700x800x580 mm

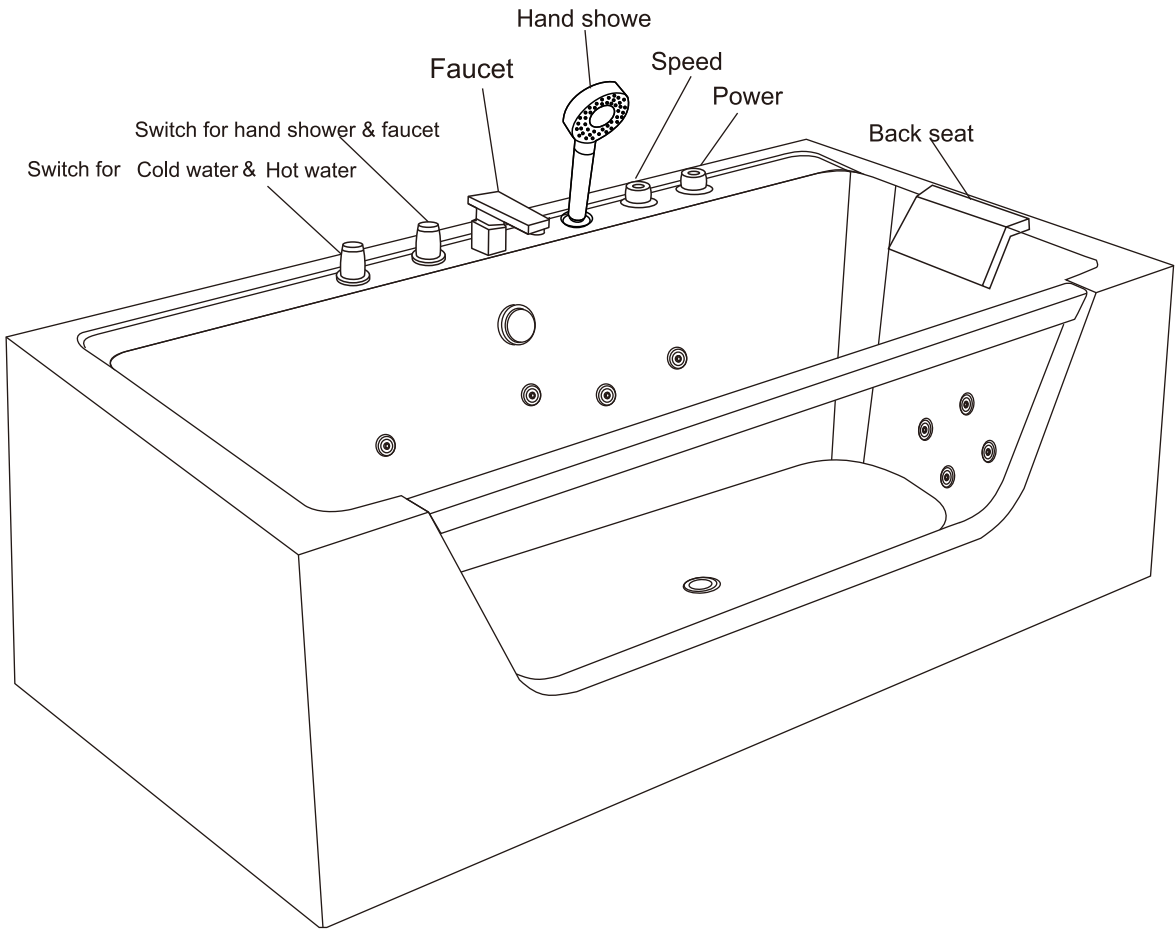

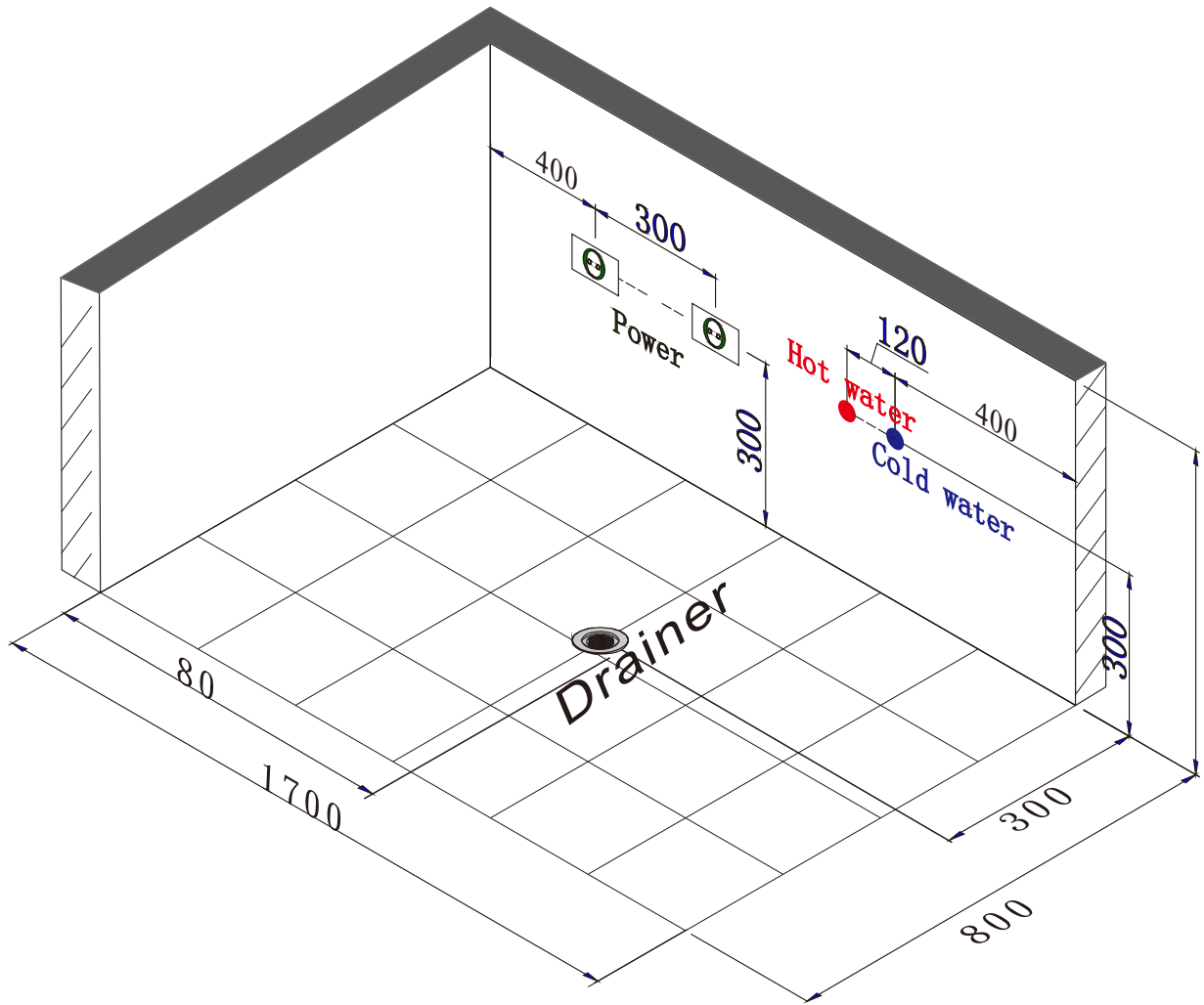



 700w (≈ 3.1A)

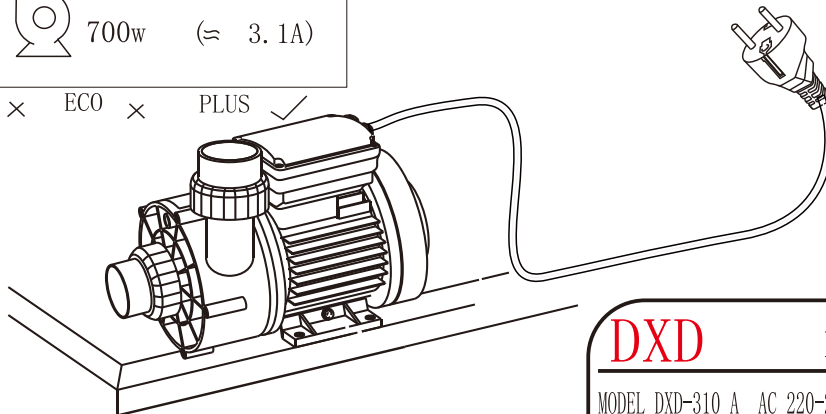

VITAL × ECO × PLUS ✓

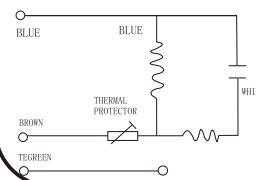

**DXD PUMP**

MODEL DXD-310 A AC 220-240V 50Hz 700W CLASS B IPX5  
 MAX WATER TEMPERATURE 50C 15u F/450V Hmin 1m



 Mround properly!  
 Do Not Start Pump  
 Without Water!

