

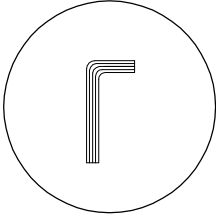

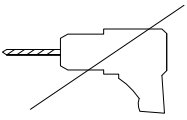





| | | |
|---|---|---|
|   |  |  |
| | | 45' |
|   |  |  |
| | | 2 |

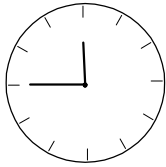
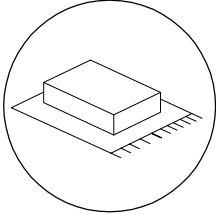
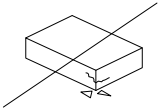

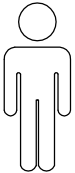
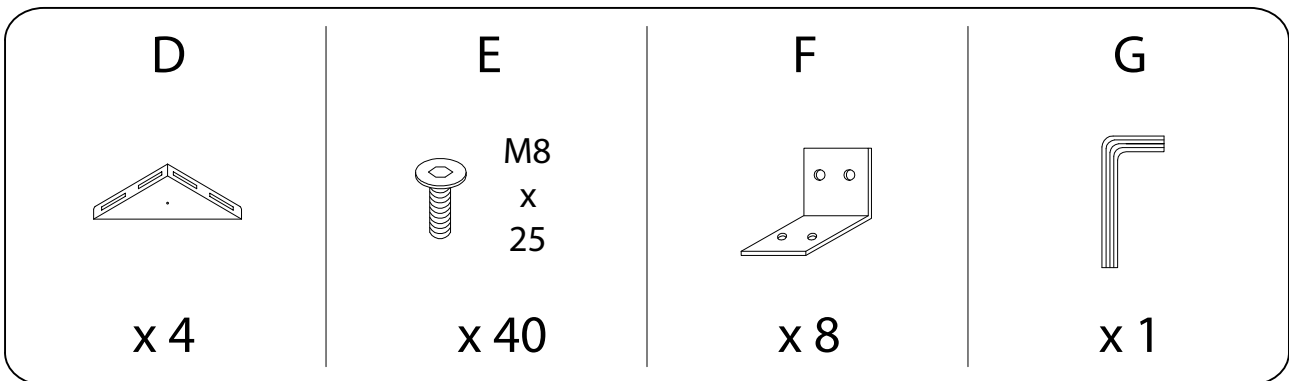
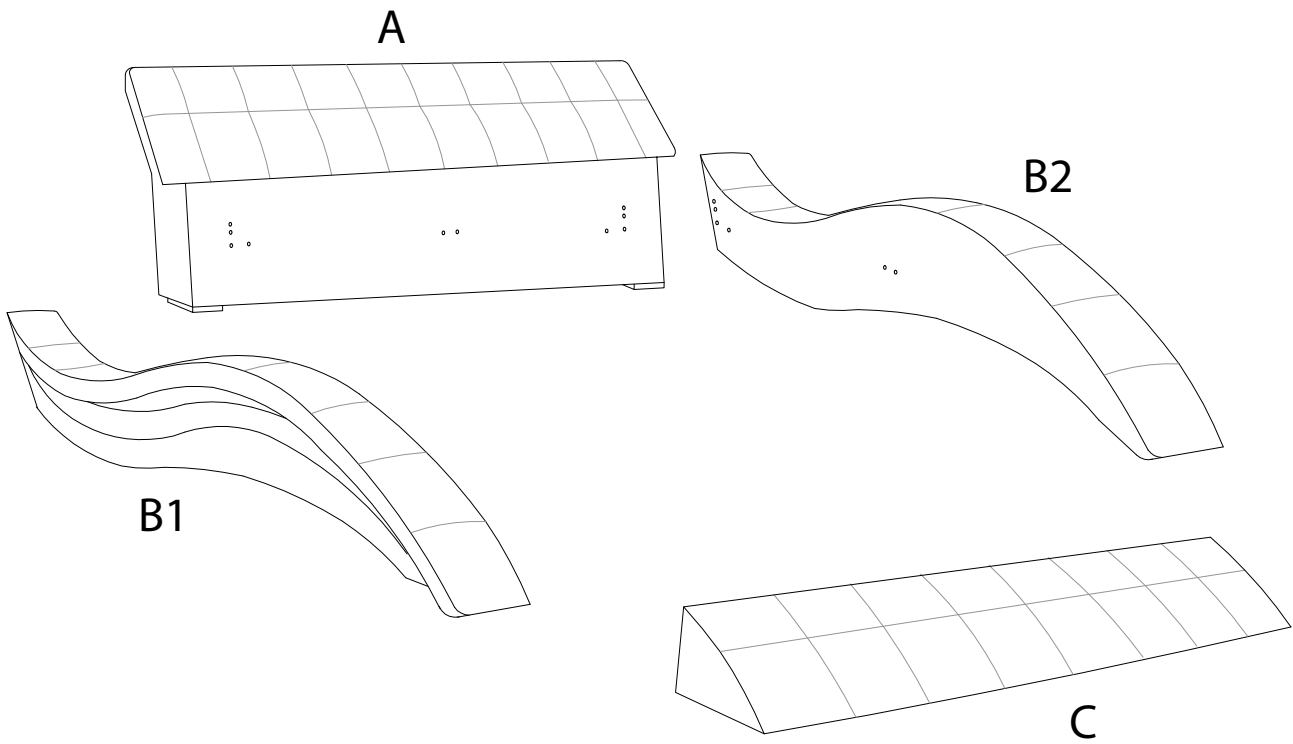
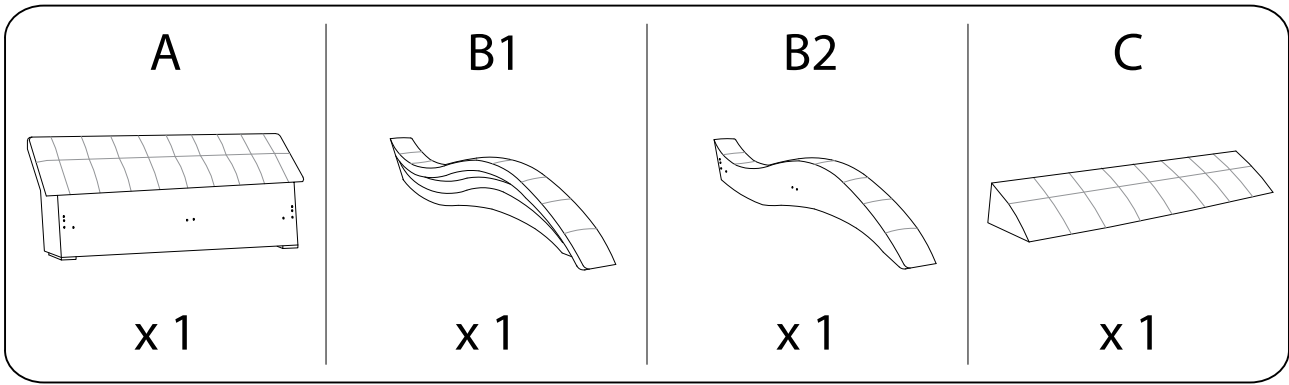
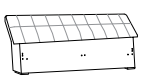
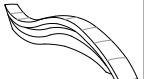

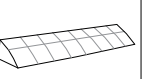
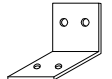
1

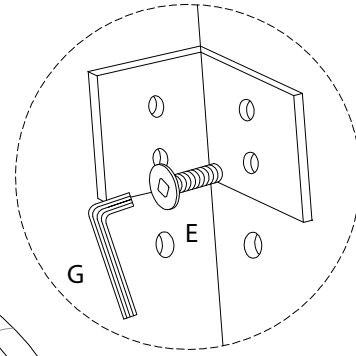
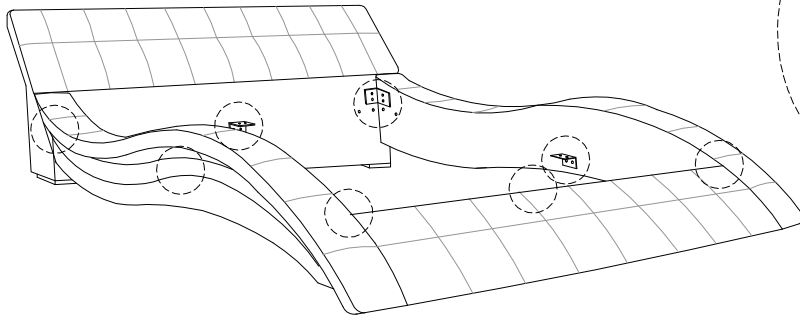
| | | | | | | |
|---|--|--|---|----------------------------------|---|---|
| A  x1 | B1  x1 | B2  x1 | C  x1 | E M8 x 25 x24 | F  x8 | G  x1 |
|---|--|--|---|----------------------------------|---|---|

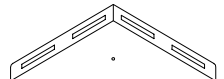

2

| | | |
|---|----------------------------------|---|
| D  x4 | E M8 x 25 x16 | G  x1 |
|---|----------------------------------|---|

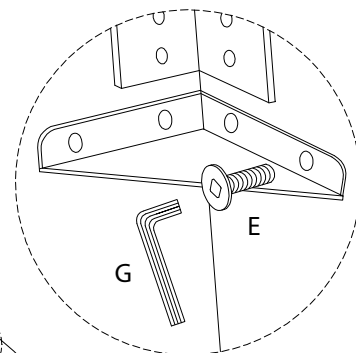
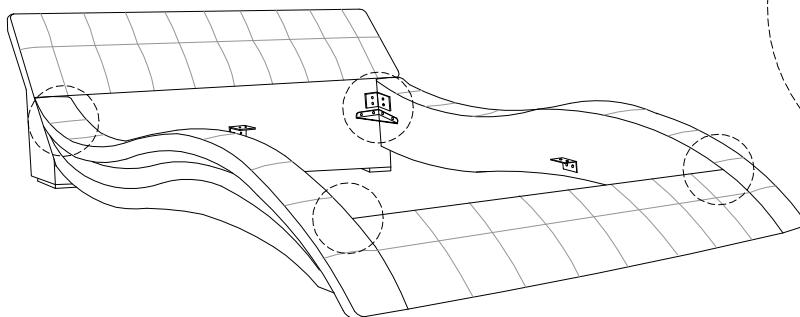

!

